

# MODERN WIRELESS



September

1/6

Vol. IV. No. 8.

Edited by JOHN SCOTT-TAGGART, F.Inst.P., A.M.I.E.E.

September, 1925.

## FORTHCOMING DEVELOPMENTS IN RADIO

By MAJOR JAMES ROBINSON,  
*D.Sc., Ph.D., F.Inst.P. Etc.*

DIRECTOR OF RESEARCH  
to RADIO PRESS LTD.,

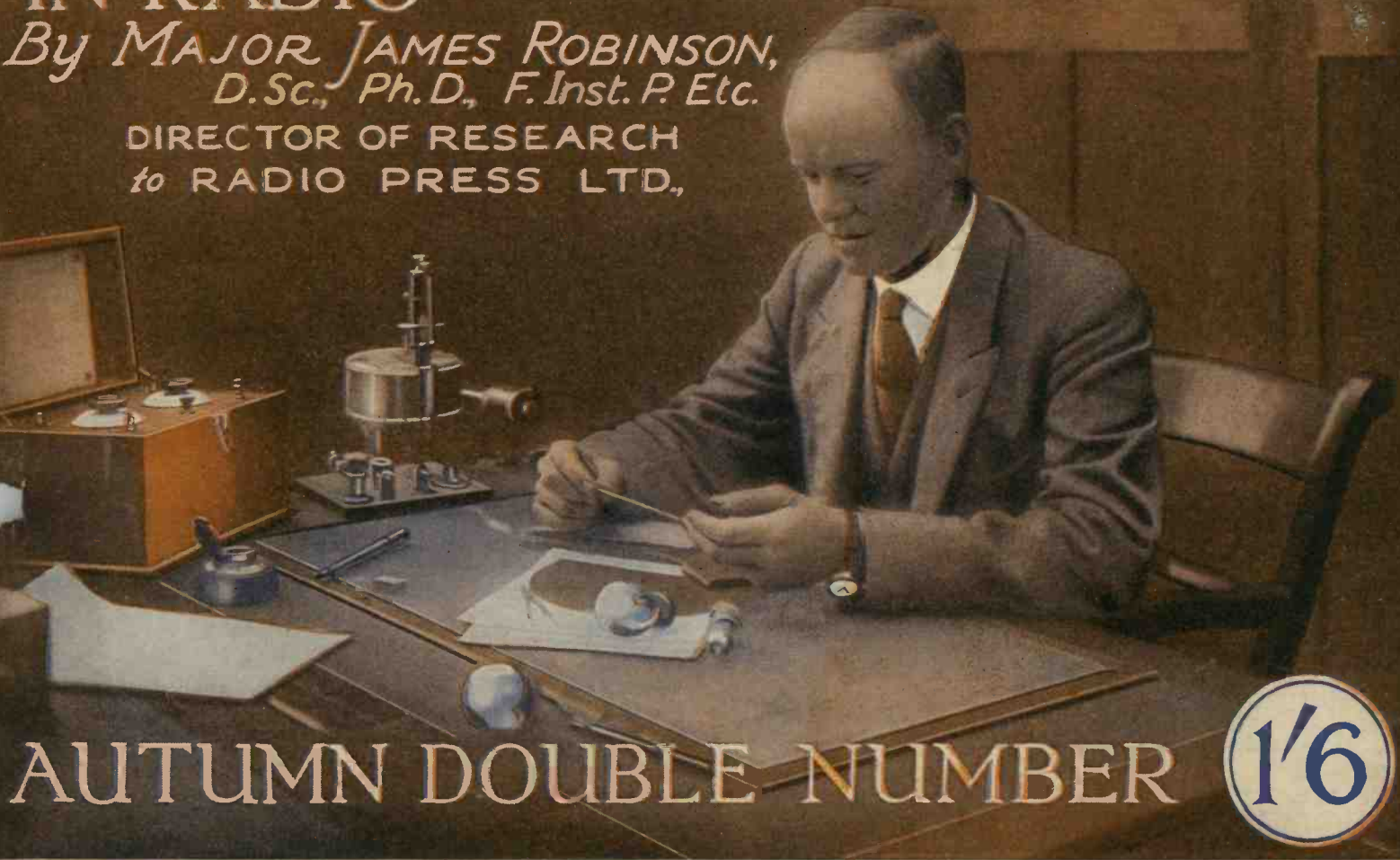

## AUTUMN DOUBLE NUMBER

1/6

**HOW TO MAKE:** A SIMPLE EIGHT-VALVE SUPERSONIC RECEIVER. *By W. H. Fuller.*  
THE "HARMONY FOUR" RECEIVER. *By Percy W. Harris, M.I.R.E.*  
THE "AMERICA THREE" RECEIVER. *By Stanley G. Rattee, M.I.R.E.*  
A SINGLE-VALVE REFLEX SET. *By A. Johnson-Randall.*  
A SIMPLE CRYSTAL RECEIVER. *By D. J. S. Hartt, B.Sc.*  
**ANODE-INPUT CIRCUITS.** *By John Scott-Taggart, F.Inst.P., A.M.I.E.E.*  
**GETTING THE MOST FROM H.F. VALVES.** *By J. H. Reyner, B.Sc., A.C.G.I., D.I.C.*  
**A LISTENER IN NEW YORK.** *By Percy W. Harris, M.I.R.E.*  
CALL-SIGNS OF EXPERIMENTAL TRANSMITTING STATIONS.



# A bigger and better Burndept range

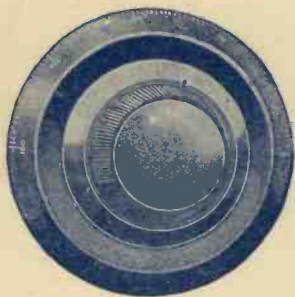

## The Burndept Super-Vernier Dial

The need for finer adjustment of condensers, etc., than is given by ordinary dials and knobs is well supplied by the new Burndept Super-Vernier Dial. It is about the same size as an ordinary dial and can be fixed to almost any set without dismantling the instrument. The mechanism—a novel friction-driven epicyclic gear—is concealed within the dial. The dial and condenser rotate at about one seventh of the speed of the operating knob, this gear ratio having been selected after careful trial as giving best possible results and velvety smoothness. The movement is absolutely noiseless and completely free from back-lash, and there are none of the loud clicking noises so often associated with geared condensers. After half a million revolutions, dials have required no adjustment. The Burndept Super-Vernier Dial is ideal for controlling condensers, reaction-couplers, variometers, etc., and greatly simplifies critical tuning.

No. 905.—Model A, for  $\frac{1}{4}$  in. spindles (where there are no projections above the panel), with knob, etc., 7s. 6d.

No. 906—Model B, for  $\frac{3}{16}$  in. and  $\frac{1}{4}$  in. spindles (one-hole-fixing condensers, etc.) with knob, distance ring, etc., 8s. 6d.

CUT HERE

To BURNDEPT WIRELESS LTD.,  
Aldine House, Bedford Street,  
Strand, London, W.C.2.

Please send me a free copy of  
the latest Burndept Catalogue.

NAME .....

ADDRESS .....

Date.....

["Modern Wireless," September 1925.]

Send now for our latest Catalogue

EVERY man who takes a keen interest in the fascinating subject of wireless and wishes to keep in touch with the latest developments of the science should write at once for the latest Burndept Catalogue which gives full particulars of the most extensive and efficient range of apparatus offered to the public, including everything from components to complete installations. Because we specialise in wireless, we are able to produce apparatus of unequalled quality which can be guaranteed to give perfect results.

Many interesting changes have taken place in Burndept Apparatus and many novel features have been introduced. In the range of instruments, the Ethodyne, a seven-valve super-heterodyne receiver of improved design, stands out prominently as the finest set ever put on the market. The introduction of Burndept Super Valves is a notable event which will arouse much attention; *these valves are guaranteed.* Burndept Coils have been improved and now cover all wave-lengths from 20 to 22,000 metres. The Burndept Super-Vernier Dial will become as popular a component as the Anti-Phonic Valve Holder. As the important advances that have been made cannot all be indicated here, we strongly advise you to secure a copy of our latest catalogue at the earliest opportunity.

Don't miss the Burndept Exhibit at the  
N.A.R.M.A.T. Wireless Exhibition at the  
Royal Albert Hall, September 12th to 23rd.  
Stands 11 and 12, Boxes 74 and 75.



HEAD OFFICE :

Aldine House, Bedford Street, Strand, London, W.C.2.

Telephone : Gerrard 9072. Telegrams : Burndept. Westrand, London.

BRANCHES at Birmingham, Brighton, Bristol, Cardiff, Exeter, Glasgow, Leeds, Manchester, Newcastle, Northampton, and Nottingham.

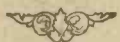

**Editor:**  
 JOHN SCOTT-TAGGART,  
 F.Inst.P., A.M.I.E.E.

**Assistant Editor:**  
 PERCY W. HARRIS, M.I.R.E.

**Staff Editors:**  
 E. H. CHAPMAN,  
 M.A., D.Sc.  
 A. D. COWPER, M.Sc.  
 R. W. HALLOWS, M.A.  
 G. P. KENDALL, B.Sc.  
 A. JOHNSON-RANDALL,  
 STANLEY G. RATTEE, M.I.R.E.  
 J. H. REYNER, B.Sc., A.C.G.I.,  
 D.I.C.

**Radio Press, Ltd.,**  
 Publishers of "Wireless Weekly" and "The  
 Wireless Constructor,"  
 Bush House, Strand, W.C.2.  
 Telephone.—City 9911.

# Contents

	PAGE
Forthcoming Developments in Radio ... ..	819
By MAJOR JAMES ROBINSON, D.Sc., Ph.D., F.Inst.P.	
The Harmony Four ... ..	827
By PERCY W. HARRIS, M.I.R.E.	
Testing Anode Resistances ... ..	833
By G. P. KENDALL, B.Sc.	
Receiving Daventry ... ..	834
By A. D. COWPER, M.Sc.	
The America Three ... ..	837
By STANLEY G. RATTEE, M.I.R.E.	
A Listener in New York ... ..	844
By PERCY W. HARRIS.	
A Simple Eight-Valve Supersonic Receiver ... ..	850
By W. H. FULLER.	
Anode-Input Circuits ... ..	857
By JOHN SCOTT-TAGGART, F.Inst.P., A.M.I.E.E.	
A Sharp Tuning Two-Valve Set ... ..	861
By E. J. MARRIOTT.	
Efficiency in Inter-Valve Circuits ... ..	866
By J. H. REYNER, B.Sc., A.C.G.I., D.I.C.	
Volume With One Valve ... ..	873
By A. JOHNSON-RANDALL.	
The New Importance of Super-Regenerative Circuits and Their Operation ... ..	890
By MAJOR JAMES ROBINSON, D.Sc., Ph.D., F.Inst.P.	

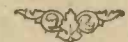
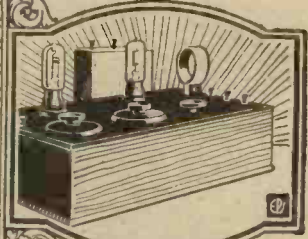

**Scientific Adviser:**  
 Prof. G. W. O. Howe,  
 D.Sc., M.I.E.E.

**Advisory Editors:**  
 Prof. R. WHIDDINGTON,  
 M.A., D.Sc., F.R.S.  
 Prof. C. L. FORTESCUE,  
 M.A., M.I.E.E.

**Advertisement Managers &  
 BARCLAYS  
 ADVERTISING LTD.,**  
 Bush House, Strand, W.C.  
 Tel.—City 9911.



All correspondence relating to contributions is to be  
 addressed to the Editor of "Modern Wireless."  
 Nothing contained herein is to be regarded as permission  
 or encouragement to infringe any patent rights.

# SERVICE

SUPERLATIVE RADIO PRODUCTS

Ask your  
 Dealer  
 for it

The new SERVICE  
**SQUARE-LAW LOW-LOSS FINE TUNING CONDENSER**

(Patent pending)  
 (For coarse and fine tuning)

Exceptionally fine tuning can be obtained by the **100-1 Reduction Gear.**

**Salient Features**

1. Exceptionally Fine Tuning obtained by the 100 to 1 Reduction Gear. "Service" Condensers are made with the highest ratio geared adjustment ever developed for fine tuning.
2. Low Wave Stations can be easily separated, the special shaped vanes giving straight line frequency variation.
3. Hand Capacity effects are eliminated by means of a special device which completely insulates the hand spindles from the working Vanes.
4. Brass Vanes soldered together to minimise resistance losses. Vanes have direct No Loss metallic paths to their terminals.
5. Frictional and erratic contacts entirely dispensed with.
6. Numerous other Low Loss features in the design of "Service" Condenser.
7. Sound Constructional job mechanically and electrically efficient.

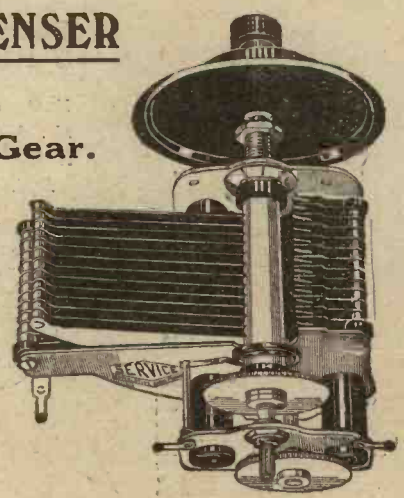

Prices :  
 '001 mfd. 25/- '0005 mfd. 20/-  
 '0003 ,, 18/6 '0002 ,, 17/6

**SOLE PRODUCERS:— THE SERVICE RADIO Co., Ltd.,** 67, Church Street, Stoke Newington, LONDON, N.16.





HIGH POWER C.W. TRANSMITTER  
INSTALLED BY RADIO COM. CO. LTD.



1/4 KW. TRANSMITTER & RECEIVER (MARINE)  
INSTALLED BY RADIO COM. CO. LTD.

World-famous Radio Engineers  
are designing your set  
when you use  
**“Polar”**  
Components

Whatever circuit you may select, the ultimate efficiency must depend on the components used. Specify POLAR Components and rely on their SOUND DESIGN.

Polar Components are sold by every good-class Wireless Dealer. Polar Service Agents in every Town will assist you in designing, building and maintaining your Set.



RESISTANCE CAPACITY  
POLAR UNIT.

It embodies wire-wound anode resistance, Grid leak and specially built Dubilier Condenser. It is perfectly self-contained, occupying minimum space, with four clearly marked terminals, correctly positioned for easy and neat wiring.  
Price 15/-

Look for the Triangular Polar Service Agents' Signs, and there you will find



the real service that stands behind all POLAR GUARANTEED COMPONENTS.

POLAR VARIABLE CONDENSER  
.001, .0005, .0003, .00025, or .0002.



The Polar Condenser gives an even scale of wave frequencies, and the mostly used lower part of the scale gives a small variation in capacity for a large movement of the pointer, thus giving a vernier adjustment.  
Price 10/6.

**RADIO COMMUNICATION CO., LTD.**  
34-35, Norfolk St., Strand, London W.C.

Visit our Stand,  
No. 5 at the Albert  
Hall Exhibition,  
Sept. 12th-23rd.



POLAR CAM VERNIER VARIABLE  
CONDENSER

Is a compensated square law condenser in which the straight line law always remains true, because the additional capacity introduced by the circuit is provided for by assuming an average figure common to most circuits. The Polar Cam Vernier Variable Condenser is the only condenser on the market to give a vernier reading on the scale: the one knob does the duty of the two in other condensers. Polar Cam Vernier Variable Condensers are manufactured in three capacities—0.01 mfd., 12/6; .0005 mfd., 11/6; .0003 mfd., 10/6

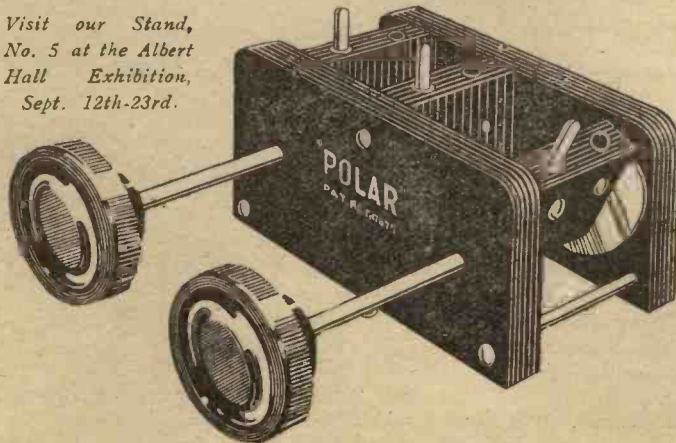

The Polar Cam Vernier Coil-Holder, ("J" Type.)

The patented cam principle of operation is unique, simple and fool-proof, giving perfect control of both fine and coarse adjustments with a single knob. Gives 10 degrees of vernier movement in any position of sweep. To lock in positive drive knob is pulled outwards. Two-way model supplied with either left or right-hand drive.

Two-way, 8/-

Three-way, 9/6

POLAR INTERCHANGEABLE BOBBIN  
RHEOSTAT.



You can change your Polar Rheostat Bobbin at any time after you have finished wiring up your set. Simply loosen the milled nut, slip the bobbin off, and a new one on. There is a resistance bobbin for every type of valve, and for every range of voltage up to 6 volts. Bobbin 2/8 and 3/6. Holder 2/9. Complete, 5/6 and 6/6.





# FORTHCOMING DEVELOPMENTS IN RADIO

By

MAJOR JAMES ROBINSON,  
D.Sc., Ph.D., F. Inst. P.

DIRECTOR OF RESEARCH  
TO RADIO PRESS LTD



**I**N an art which has developed so rapidly as Broadcasting and which is still developing rapidly it is not easy to forecast precisely what the state of the art will be in a few months' time; there are so many factors to be considered and there are so many problems still unsolved. Many people are now trying to solve new problems, and at any time some new discovery or invention may make radical changes essential.

## Amateur Enterprise

It is very gratifying that one of the greatest problems in wireless which still remains unsolved is being attacked by amateurs, and it is to amateurs that a considerable amount of credit must be given for the pioneer work they have done. This is in the development of short-wave work for long distances. The problem is to discover whether on any wave, long distance communication can be guaranteed at all times of the day on comparatively small power. Much can be said about this, but as it is still unsolved it is not easy to state whether its applications to broadcasting will be along the lines of shortening the wavelengths used, or of using higher power transmitting stations on the present wavelengths. This question will be left for the present.

## Types of Listeners

Accepting the present conditions of the broadcasting transmitters and of how the wavelengths used are carried through space, there are many factors under the control of the receiver about which it is possible to give some idea of future development. Here, again, there are different types of listeners to

be considered, which can be broadly classified into two groups: (a) those who are particularly interested in reaching out or getting long distance broadcasting, and

*Dr. Robinson was the successful applicant for the advertised post of Director of Research to Radio Press Ltd., a post carrying a minimum salary of £2,500 per annum. He has retired from the position of Wireless Head of the Royal Air Force to take charge of the great new wireless laboratories we are building at Elstree, 10 miles north of London.*

*Dr. Robinson's article on page 890 is of vital interest to all experimenters.*

(b) those who wish to hear their local station perfectly. Some people tend to call these two classes respectively searchers after science, and searchers after art, but this is by no means fair, as there is a considerable amount of science required by the latter class, in order to obtain the best artistic effect. Fortunately it is possible to make suggestions which will be useful to both classes.

Of the conditions under the control of the listener there are (a) the aerial system, (b) the earth system, (c) whether crystal or

valve and the number and type of valves used, (d) power supply for valves, (e) the type of circuit used, (f) whether phones or loud-speaker are employed. It is proposed to narrow down this wide field and to deal principally with some features of circuit and design development.

## Range of Receivers

As regards the extension of the range of receivers, the ordinary principles of straightforward circuits are well known and have been often described in this journal. One can use stages of straightforward high frequency amplification, rectification, and some stages of low frequency amplification. There are limits to such methods, however, as difficulties of reaction arise when too many stages of high or low frequency valves are used. Theoretically, however, and assuming there is unlimited space and money, one can obtain as much amplification as is required by this means. It must be remembered, however, that amplification alone will not increase the range. Elimination of interference must go hand-in-hand with amplification.

The drawbacks of interaction and cost have made inventors search for other methods of amplification.



The question of economy of valves used lies at the basis of many advances in wireless reception. Certain principles are in use now which enable considerable economy of valves to be effected.

**Present Methods**

One of the most important of these is the well-known reaction method. Another is to use one valve for more than one purpose; such a method is usually called reflex working, and is in very great use. Neutrodyne methods also are destined to have a great

blematical; it is commercially possible, but whether large numbers of the general public will be able to build complicated sets involving reflex action and also super-heterodyne principles is yet to be seen.

**Super-Regenerative Circuits**

Another important advance of recent years is the super-regenerative circuit. No doubt many readers will imagine that when I mention this circuit I am dealing with an obsolete idea. I deliberately say, however, that the super-

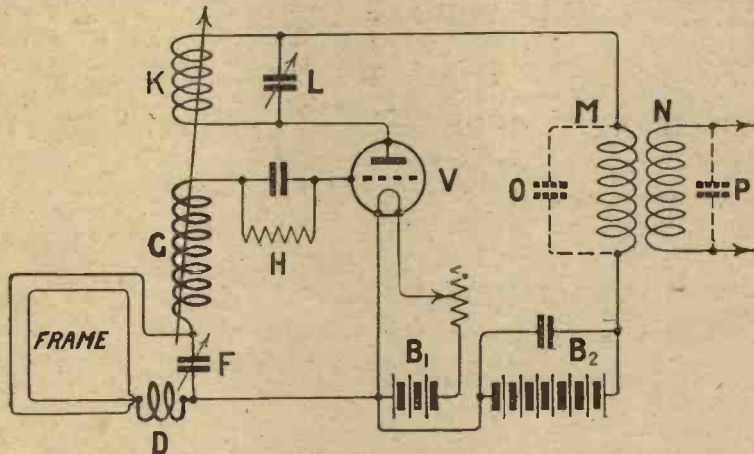

Fig. 1.—In this arrangement the valve is made to function both as local oscillator and first detector.

immediate future, and the designs produced in this country will undoubtedly be considerably improved as a result of further research work and certain changes in respect of the whole design of wireless receivers. Some indications of the probable change of outlook are given later in this article. Meanwhile, I would like to indicate that the essential fact to bear in mind in design work is to get the absolute maximum from each piece of apparatus rather than to make up for deficiencies by increasing the number of valves. There is not the slightest doubt that the average high frequency amplifying valve is only carrying out part of the work which it should be doing, and that very much greater amplification is not only theoretically obtainable, but can actually be achieved if certain methods are used.

**The Super-Heterodyne**

Another method for increasing range is the super-heterodyne system, which is destined to receive very serious consideration during the next year. Whether the use of reflexing methods in conjunction with super-heterodyne receivers is going to be a success is pro-

regenerative circuit is by no means obsolete, and that much will continue to be heard of it. My experience and the information I have in my possession lead me to believe that there will be a real field for super-regenerative receivers, particularly on the shorter wavelengths, including those used by such stations as KDKA.

**Popularity of Super-Heterodynes**

It is not surprising that the popularity of super-heterodyne sets is increasing rapidly, for there are very many desirable features about them. It is possible to design such a set for a fairly wide range of wavelengths so that the wavelengths can be changed in the easiest possible manner, whilst the amplification over the whole range need not vary much. In addition to this quite a small aerial can be used, and in fact, a small loop aerial is very suitable, so that the set can be made portable if required. An excellent feature is of course the great selectivity that is obtained. Such sets are not suitable for long wavelengths, but as the B.B.C. stations are on the 300 to 500 metres (999 to 600 kc) band, the super-heterodyne is especially suitable in this country.

**Principles Involved**

The principle of the super-heterodyne is so well known that only a brief reference to its operations is necessary. A local oscillator is employed to produce beats with the incoming signals, and the frequency of these beats can be obtained the same for any signal in the wavelength range by adjusting the frequency of the local oscillator. After rectifying these beats the problem of amplification is straightforward, for we can build an amplifier for one frequency, which is much simpler and more efficient than having to design a high frequency amplifier which has to work on a variety of frequencies. This frequency is usually chosen to be between about 150,000 and 30,000, corresponding to wavelengths of 2,000 metres and 10,000 metres. After amplification of this single frequency, the signals can be obtained in the telephones after rectification, or if required low frequency amplification can be employed for use with a loudspeaker. In its simplest form the super-heterodyne thus consists of the following parts:—

1. An aerial, which may be a loop aerial.
2. An oscillating valve, with circuits tuned to the frequency of the local oscillations, and also circuits tuned to the incoming frequency. This valve can also act as a rectifier.
3. Two or three valves to amplify the beat frequency.
4. One valve as rectifier of these amplified oscillations.
5. One, or two valves as low frequency amplifiers.

**Variations and Improvements**

Many variations of this simple form have been suggested, but some of them go along the extravagant lines of using more valves in order that each valve may perform one function efficiently. Much can be said in favour of such devices, for, undoubtedly, good results as regards quality and sensitiveness can be obtained in this way, but there are the obvious disadvantages of much extra cost and the multiplication of controls. Our object is to enquire in what ways it will be possible to effect improvements along the lines of utility, economy, and cost, without influencing the efficiency of the set or adding too many controls.

**The Oscillator**

We shall first of all consider the oscillating valve. In our simplest form of super-heterodyne the functions allocated to this valve are (a) to oscillate at a particular



frequency, and (b) to rectify the combination of the two waves, thus to provide the intermediate frequency to pass on to the next stage.

Naturally we could employ separate valves for each of these functions, but this would be at the expense of two valves in place of one. With suitable precautions it is quite easy to make the single valve perform the two functions satisfactorily.

**A Suitable Arrangement**

Fig. 1 shows a very suitable arrangement for this purpose. Examination of this diagram will show

that in addition to the aerial circuit there is one other circuit to tune, circuit KL.

The circuit DF is in the grid circuit of the valve V, and this circuit is tuned to the incoming waves. Also in the grid circuit is an inductance G, which is coupled to the inductance K of the tuned circuit KL, which is for controlling the frequency of the local oscillations, the reaction between K and G being sufficient to produce the oscillations. The incoming waves and the local oscillations are thus both provided for in this valve circuit, and they are combined in the inductance M, rectification being obtained also in the valve, by the use of the grid leak arrangement H. This supersonic frequency is now ready to pass on to the amplifier through the transformer MN. If necessary, the primary and secondary of this transformer can both be tuned, and in fact this tuning might be made variable if required. It is preferable for ease of control, however, to use high frequency transformers without any means of varying their natural tuning, a filter circuit, of course, being used.

**Interesting Features**

There are certain interesting features about this circuit, consideration of which will be valuable. We are dealing with two distinct frequencies (incoming and local oscillations) in the same valve circuits, an alteration in the tuning of either DF or KL will effect an alteration of tuning of the other circuit. This interaction becomes more troublesome the nearer the

frequencies are together. Methods of dealing with this will be dealt with shortly.

The first device that suggests

be lower than that already used, and, in fact, half the value. This oscillation has harmonics, and the first harmonic (double the frequency) takes the place of the oscillations described above, and beats are produced between this first harmonic and the incoming waves. The actual oscillating frequency is now so far removed from that of the incoming waves that the two frequencies can be adjusted independently of one another.

Various auto dyne circuits including the "Tropadyne" a form of which is given in Fig. 2 are likely to become

very popular in view of their simplicity.

It is often necessary to arrange for a certain amount of amplification of the incoming signals before they reach the oscillating valve. This may be done by using a valve for the high frequency amplification of the incoming oscillations. This can be done even without any further adjustments of tuning being necessary, but it is at the expense of a further valve.

**Reduction of Interference**

In addition to its use as a high frequency amplifier, this extra valve performs another function, in so far as it cuts down the oscillations which would radiate from the aerial. By careful arrangements of the various parts, it is possible to make the oscillations in the aerial negligible. This is a very desirable condition, for essentially the super-heterodyne set is an oscillating set, and if these oscillations get back to the aerial, no matter whether a loop aerial is used, radiation takes place, which will annoy other listeners over a considerable area. This question of the loop aerial radiating is one to which considerable attention should be given. There is a tendency to assume that because a loop is a poor aerial for reception, in comparison with an open aerial, the radiations from it will necessarily be small, and that the very fact of using a loop aerial for reception is a guarantee that one is not annoying one's neighbours. Actually, loops are such good radiators, particularly on the

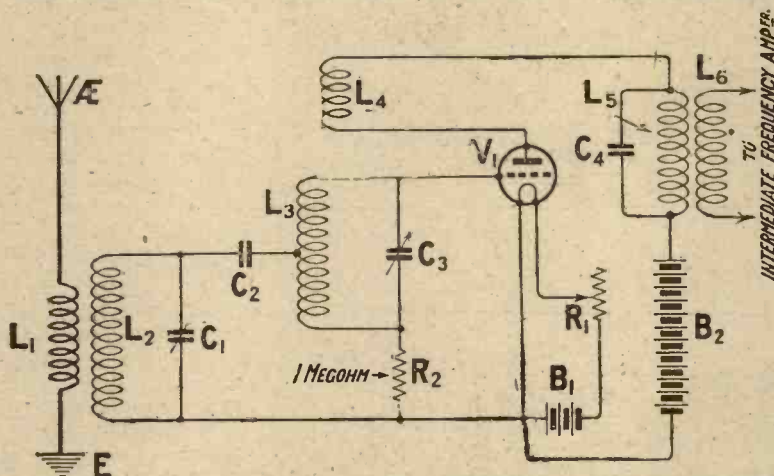
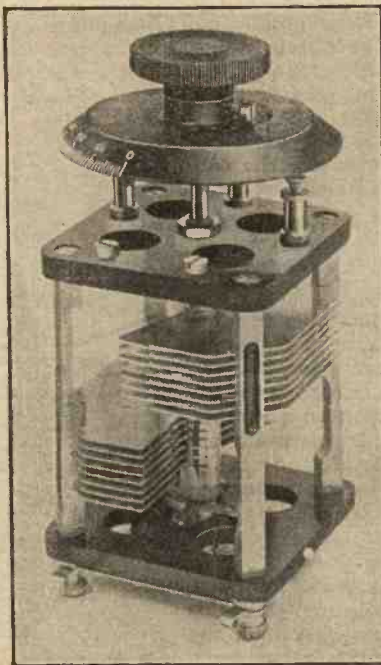

Fig. 2.—Another arrangement in which the valve acts as a local oscillator and detector is the Tropadyne circuit.

itself to minimise the alteration of the tuning of one circuit by an alteration in tuning of the other, is to make the capacity F of the tuned circuit for the incoming waves large, and the inductance D correspondingly small.

**Use of the Second Harmonic Principle**

Armstrong, in his well-known Radiola set, overcomes the difficulty in quite a different way. He arranges the oscillating frequency to



A unique low-loss condenser of modern design



comparatively short wavelengths of the B.B.C., that they are being used at present as transmitters in certain quarters.

**A Rejector Circuit**

If one does not use a separate high frequency stage of amplification, there is a useful device which will prevent oscillations getting to the aerial. This is very similar to the rejector circuit, described elsewhere in this article.

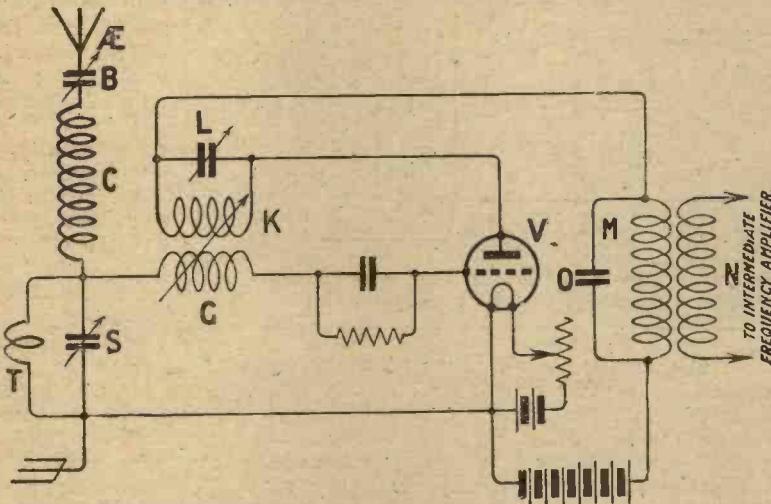

Fig. 3.—In this arrangement the circuit TS acts as a rejector and so prevents radiation.

The arrangement is shown in Fig. 3. In the aerial circuit there is included another oscillating circuit consisting of an inductance T and condenser S in parallel. The grid circuit of the valve V is joined across the terminals of the condenser S. The circuit ST acts as a rejector, and thus it should have as little damping as possible, and the condenser S should be large, and the inductance T very small and of thick copper. The rejector circuit is tuned to the frequency of the incoming waves, and so also is the aerial circuit BC. This circuit ST, being tuned to the frequency of the incoming waves, forms a high impedance for these oscillations and thus allows them to pass to the grid of the valve V. On the other hand, for the oscillations produced by the valve, which are of a different frequency, the resistance offered by the circuit ST is small, and thus these oscillations pass through this circuit and are prevented from reaching the aerial. The same idea is, of course, applicable to frame aeri-

**Economy in Valves**

We shall now turn our attention to the supersonic amplifier and the low frequency amplifier. In the

simple circuit outlined at first, provision was made for 2 or 3 stages of supersonic amplification. Supposing 3 stages are employed and 2 stages of low frequency, there will be 6 valves needed (including one rectifying valve after the supersonic stages) in addition to the oscillating valve, making 7 valves in all. It is possible to economise on these valves in certain ways. One method is to employ a certain amount of reaction in the super-

second valve is an oscillator and also the frequency changer (being also the detector), the third is a supersonic amplifier, the fourth a detector and the fifth and sixth are low frequency amplifiers. Reflex action is used in the supersonic stage, from the third valve to the first, and thus the first and second valves have an additional function to perform—that of supersonic amplifiers.

**Reflex Action of both H.F. and L.F. Valves.**

The reflex action can be carried to another stage, and Mr. Scott-Taggart has designed a circuit in which reflex action is employed both for the supersonic and for the low frequency stages. The broad idea is to use a single valve for three or many more stages of amplification, the frequency of the current being changed for every stage.

The object of one of his circuits (Fig. 4) is to employ the first valve for three successive amplifications, that of the incoming waves, that of the supersonic frequency and that of the low frequency effects. The diagram is clear, and the operation will be understood from the following description:—

**An Explanation**

The incoming waves are received by the aerial and transferred through the tuned circuit  $L_1 C_1$  to the grid and filament of the valve  $V_1$ . They are there amplified and conveyed from the anode circuit through the high frequency transformer  $L_2 L_3$  to the grid of the valve  $V_2$ . This valve also receives the local oscillations from a source H, which will, for con-

sonic stage of amplification, and so cut out one valve. Caution must be used in this device or it will be difficult to prevent the supersonic part of the amplifier from oscillating. Assistance may be obtained by using a potentiometer, so as to introduce damping into the grid circuits of each of the supersonic valves, so as to stabilise the conditions.

**Reflexing the Supersonic Stages**

Another and more hopeful device to economise on valves is to use one valve for various purposes, in other words use reflex working. In the Armstrong Radiola set this is used in one way, for the supersonic frequency. In this six-valve set, the first valve is a high frequency amplifier, the

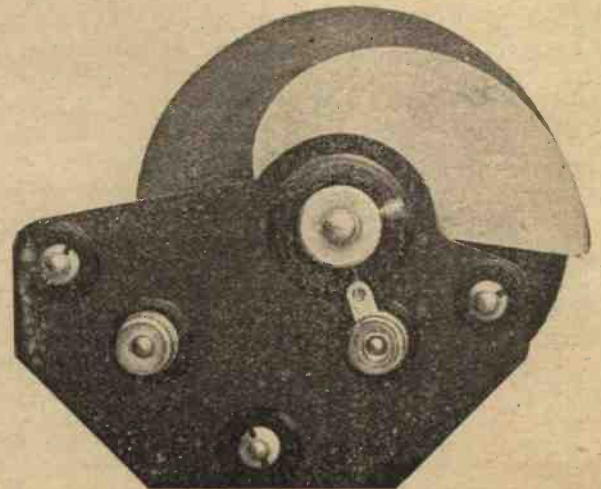

A typical example of a square-law or straight line wavelength condenser showing the shape of the moving plates.



venience, be a valve oscillator. The two sets of oscillations are thus combined in this valve  $V_2$  to form a supersonic frequency. Rectification is also performed by this valve, and the supersonic frequency is taken from the anode to the high frequency transformer  $L_7, L_8$ , the circuit  $L_2, C_2$  being tuned to the supersonic frequency. This circuit  $L_2, C_2$  forms part of the grid circuit of the valve  $V_1$ , and thus the supersonic frequency is amplified by  $V_1$ .

**Rectification**

On emerging from the anode these supersonic oscillations are taken by way of the transformer  $L_4, L_5$  to the grid of the valve  $V_3$  where they are rectified and conveyed to the low frequency transformer  $T_1, T_2$ , the secondary of which  $T_2$  is shunted by a condenser  $C_6$ . Again the circuit  $T_2, C_6$  forms part of the grid circuit of the first valve  $V_1$ , and the low frequency effects are thus amplified also by the first valve. They are then carried to the loud-speaker. The first valve as given is not a dual amplifier only but a "three-stage" amplifier all in one; there is theoretically no reason, according to Mr. Scott-Taggart, why one valve should not carry out many more stages of amplification, provided the frequency is changed each time and the frequencies are not too close together.

**Patent Specification**

The type of circuit which Mr. Scott-Taggart has shown me (extracted from a patent specification of his dating back a year and a half ago, but not published yet) is disclosed here for the first time. Its development may lead to very surprising results. The advantages of reflex circuits may, by its means, be multiplied many times.

The American Western Electric

Company has also evolved a system for the multiple amplification of signals with one valve, and this circuit is shown in Fig. 5. It is a complicated arrangement, using filters, and depends upon a modulation method of changing frequencies, each frequency being amplified by a single valve.

**Future Developments**

The direction in which super-heterodyne receivers will de-

velop is not easy to predict. The general tendency will be to keep the number of valves down to a minimum, and already a good example of a receiver using a minimum number of valves is that of the Radio Corporation of America, in which long-wave reflexing is carried out. The elimination of the external heterodyne is almost a foregone conclusion, although this modification introduces new problems which require solution. The self-heterodyne (or autodyne) type of circuit eliminates one of the valves, the

Tropadyne type of circuit (which incidentally, was invented by a member of my staff at the Royal Air Force laboratories four years ago) being a well-known example. The introduction of a stage, or stages, of high-frequency amplification into the super-heterodyne involves further complications, and also an increase in the number of adjustments necessary, and one of the problems of the near future is undoubtedly the elimination of unnecessary controls.

**Public Requirements**

The general public in this respect differs from the experimenter; a graduated dial is probably all the public really requires in a wireless receiver, the movement of a single knob providing the listener with programmes from different stations without interference from others. Whether the experimenter will descend to this level or not is doubtful. I am not sure that a few controls provide considerably more interest than a single knob. The reason for this is not merely that there is more to experiment with, but something has almost invariably to be sacrificed if there is to be a reduction in the number of controls. It is possible to produce a

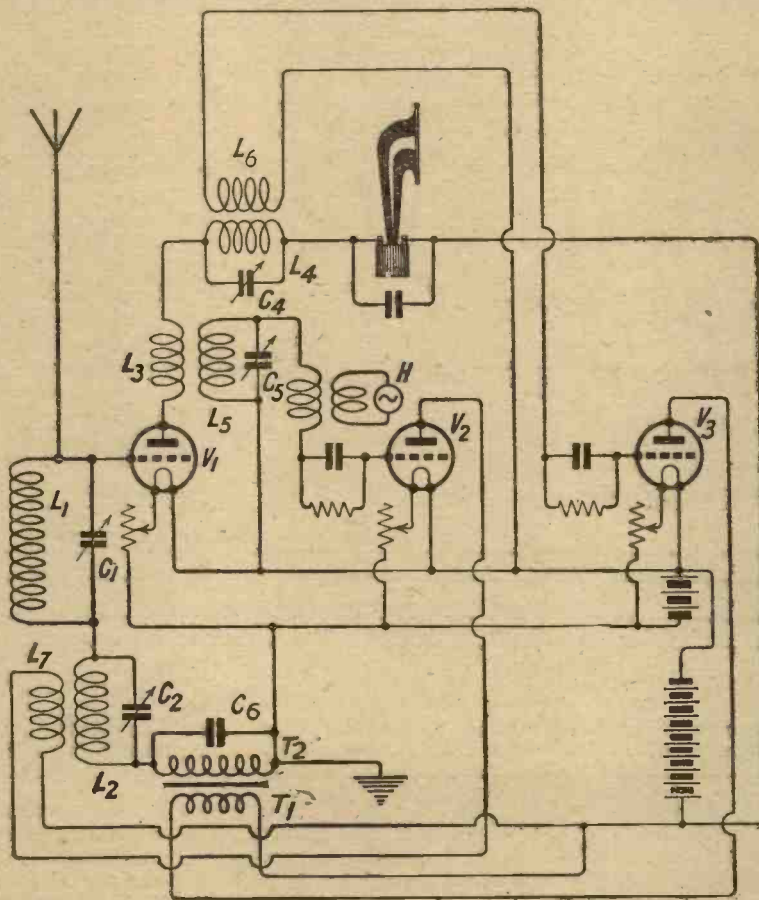

Fig. 4.—In this arrangement the valve  $V_1$  amplifies first at the fundamental frequency, then at intermediate and low frequencies.

super-heterodyne receiver without any other controls than a single knob which varies a single condenser. Such a simplification is, however, at present only possible in the case of very high frequencies (very short wavelengths). It is, of course, also theoretically possible, as Mr. Percy W. Harris suggested a considerable time ago, to use a single control to tune the reception circuit and the oscillator circuit simultaneously. The carrying out of such an idea, however, would be a highly skilled instrument-maker's work, and there is little



immediate hope of a satisfactory solution on these lines from the view point of the home constructor.

**Components**

Manufacturers, however, are realising that there is a market for certain classes of components which require more than the ordinary skill possessed by the average home constructor of wireless sets. This, of course, will greatly simplify the work of our new laboratories at Elstree, and some important developments in the way of super-sonic heterodyne receivers may be expected from this source in the near future.

Little has yet appeared regarding the reception of very short wave-

D.I.C., of our laboratories, has created a great deal of interest, and surprising results have been obtained from experimental work carried out. It is not unlikely that in the near future there will be a tendency for aerials to be of different shape and some of the types of aerials already in existence, which look rather like the result of crank ideas, will become more and more popular. The type of vertical aerial with a concentrated capacity at the top is more efficient than is generally imagined. The roof-top mast aerial was probably first originated by someone who had no conception of the technical merits of the idea. We have during the last two years

appear an additional expense, but the Radio Press are tending to come to the conclusion that, although sets which will receive both short and long wave stations will remain, yet separate sets of very high efficiency will be designed for the stations working on the 300-500 metre waveband or a somewhat wider one.

**Waveband Extending**

It is important to note at this stage that this waveband is gradually being extended. There are a large number of foreign broadcasting stations which have been erected during the past year or two and more are being proceeded with. The British wave-

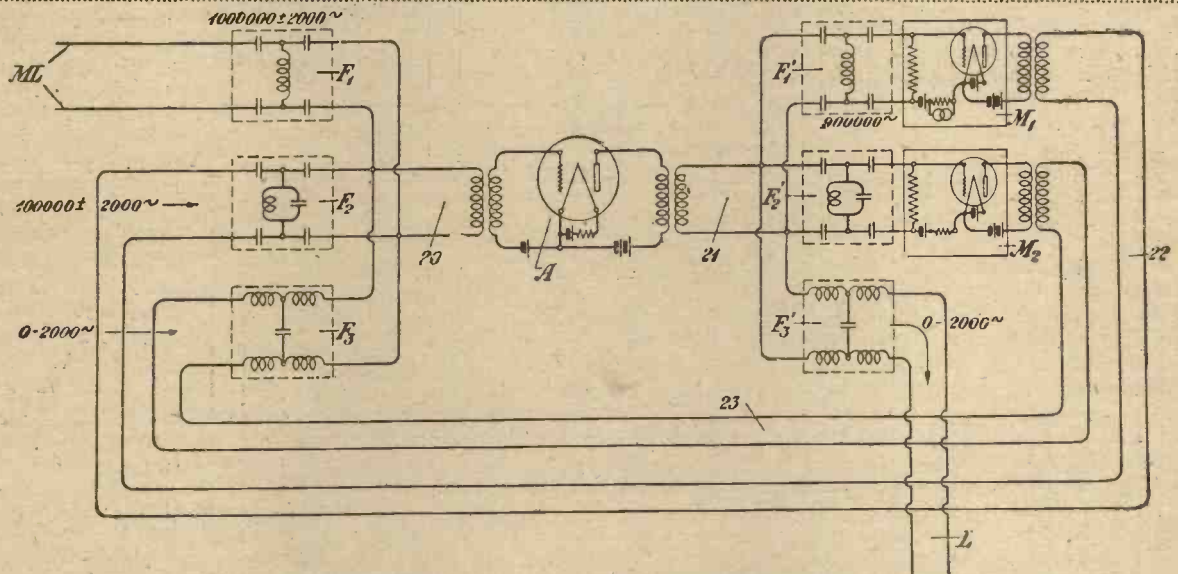

Fig. 5.—A reproduction of the patent drawing illustrating the method used by the American Western Electric Co. for the multiple amplification of signals.

lengths by means of super-heterodyne receivers, the normal reception band being that of 200 to 600 metres (1499 to 500 kc.).

**A Proposal**

In subsequent articles I propose to deal in detail with different sections of this subject and also others mentioned in this article, but for the present I am confining myself to a brief résumé of possible, or rather probable, developments in radio technique, and outlining in many cases the lines on which improvements will take place.

**Aerial Developments**

The aerial of a broadcast receiving station is probably the most neglected factor of all. An article which recently appeared in MODERN WIRELESS by Mr. J. H. Reyner, B.Sc. (Hons.), A.C.G.I.,

seen types of aerials which have been marketed and which are technically ludicrous, but there are others which appear curious though actually possessing definite merits.

**Effect of Wavelength Band on the Design of Wireless Receivers**

The frequency band on which the broadcasting stations work is, in the case of British stations, from 999 kilocycles to 600 kilocycles (300-500 metres). There is, however, a station 5XX which works on 1,600 metres (187 kc.), and which comes entirely outside the normal waveband. The whole question arises as to whether sets have to be designed for the reception of the main broadcasting stations and also 5XX or whether special sets should be specially designed for the 300-500 metre waveband, and separate sets for 5XX. This may

band is consequently now being extended so as to include foreign stations as well, because imminent development in receiver design and, in fact, existing designs, enables foreign stations to be heard with comparative ease. The fact that there is a considerable amount of jamming is not merely due to the number of stations working, but is also due to the lack of selectivity of many existing receivers.

**Selectivity**

Both commercial and home constructed receivers are not nearly selective enough for modern conditions, and I can say with authority that very great increases in selectivity will be obtained in Radio Press designs emanating from our laboratories, and from the radio designers who write for the various Radio Press journals.

(Continued on page 926).





# In Passing

## Autumn Modes

IT cannot be denied that we wireless folk are a careless, happy-go-lucky crew who pay but little attention to the *finesse* of personal adornment. We are not, of course, all quite so bad as Professor Goop, who frequently strolls down the High Street of Little Puddleton wearing one boot and one slipper. In winter time, too, I have known him appear with socks upon his hands because he was unable to find his woollen gloves. And there was a night when he turned up at a dinner party given by Bumbleby Brown, with his evening waistcoat, turned inside out so as to display the red flannel lining, on top of his coat. The Professor's delinquencies in the way of apparel are, however, merely due to absent-mindedness. They are not, as in your own case, reader, the results of mere sloth. Nor, I think, could you justify a plea of absent-mindedness, for this can hardly hold good unless there is a mind to be absent. Yes, speaking both upon my own behalf, and, though you have not asked me to do so, upon yours, I must say



(a) human being, (b) bobbed, and (c) shingled.

that we are rather a sloppy lot. It is high time that metaphorically and literally we pulled up our socks and paid much more attention to the vastly important question of dress. It is for this reason that I have decided this month to have a little talk with you upon *modes* for the wireless man. Of the wireless woman I shall not speak, for she is quite able to look after herself.

## Thoughtless

Many a man has suffered from exceedingly bad reception with his receiving set, the cause of which

has remained a mystery to him. As he approaches the set it howls at him. If he places his hands upon the knobs and things it howls again. Should he remove them it howls worse than ever. The reason is simply that the careless fellow is clothed largely in metal. Has he not—have you not—a metal collar stud? Are there not metal buckles upon his braces, and metal thingmijigs upon his sock suspenders, if he wears them? All of these metal things are naturally earthed by being in direct contact with common clay, and as you approach your receiver eddy currents are set up in them. The man so dressed becomes in fact a living tuning plate.

## Distortion

When music is coming through distortion may not be particularly noticeable, but everyone knows the effect of a collar stud upon speech; it makes the speaker sound exactly as though he were talking through his hat. The serious wireless man will see to it that his collar stud is ebonite of guaranteed quality, and that the other bits and pieces of his attire usually made of metal are of celluloid or ivory. That enterprising firm, Messrs. Guppit & Slobbs are now undertaking a neat little Anti-eddy outfit, consisting of collar stud, brace buckles, pulley wheels and sock suspender thingmijigs mounted upon an attractive card for the ridiculous price of four-eleven-thrèe.

## The Coiffure

Next, though strictly speaking it should not come under the heading of clothes, the question of the *coiffure* arises. Wireless men may be divided roughly into three classes: (a) human beings, (b) the bobbed, and (c) the shingled. Each of the last two classes has a sub-order, the wide-whiskered. From the wireless point of view the practice of wearing long hair cannot be too strongly condemned. Every time that the telephones are put on or taken off a tuft of hair is torn

out, and this rapidly wears away the headbands. The possession of long hair is apt to produce in course of time the artistic temperament which is a terrible thing for a wireless man to have. As for side-whiskers, besides being apt to harbour bats, they get into the telephones and disturb the delicate mechanism of the receivers. A friend of mine once found himself literally in a terrible fix. When he tried to remove the headphones he found that his whiskers had become jammed between the diaphragms



The doctor called in a plumber.

and the caps. Unable to free himself, he rushed round to a doctor, who called in the services of a plumber. The headbands were cut through, but when this had been done it was found that the ear-pieces still remained firmly attached to the whiskers.

## The Only Remedy

As there was not room to insert the points of even the tiniest pair of scissors between them and the victim's cheeks there was nothing for it but for him to continue wearing them for a fortnight, by which time the whiskers had grown sufficiently to enable shearing operations to be undertaken. Those who, in spite of all warnings, insist upon cultivating flowing locks should always wear a hair net when wireless reception is toward. These can be bought quite cheaply in the most sweetly pretty colours, and if they are chosen to match exactly the telephone cords the *toute ensemble* is distinctly fetching. Confirmed whisker growers should protect their fungi and keep them out of harm's way by placing little pads of *ninon* or *crepe*



*de chine* over them, which should be fixed in place by strappings of insulating tape.

**Chapeaux**

In this age the question of indoor millinery is very much neglected by the mere male. Our stern forefathers always garbed themselves in little round caps before lighting their pipes, and none of them failed to put on his nightcap before going to bed. The nightcap, I am told, is still fashionable, though its application is now internal instead of external. Chefs and millers are still sensible enough to retain headgear for indoor wear; but that, except perhaps for the skull caps worn by baldheaded ancients in club smoke-rooms, is the present-day extent of masculine indoor headwear. Now the wireless man really requires something to protect his head from draughts on cold cheerless winter nights when he is sitting up for America.

**The Kosikap**

To meet his needs Professor Goop and I have designed something really *chic* which we are calling the Goop-Wayfarer Kosikap. This is a dear little *chapeau* made on the lines of those leather helmets which the lads of the village don before they set out to run round the country on those motor bikes that sound like machine guns. The confection is carried out in bombazine and is garnished with little bows of pink baby ribbon over the ears. It fits closely over the head and round the throat and chin, thus excluding all draughts as well as those outside noises which are



Sophonisba, the cat — strolled in.

often such hindrances to wireless work. The telephone receivers, which should be enamelled in colours to match, are removed from their headbands and hemstitched to the sides of the Kosikap. I can assure you that the effect of this delightful little *couvre-chef* is simply killing. When the Professor and I had made up the original model we took it round to Poddleby's house and tried it on him. Sophonisba, his cat, strolled in at the moment, gave one look at Poddleby and expired on the spot.

**Suitings**

Gents will choose their own natty suitings to meet their individual

tastes. The general note which should be struck is one of quiet and refined elegance. Violent checks, tartans and tiger stripes are now quite *demodés*. A perfectly charming material for a wireless suit for summer wear is dark green American cloth with a trimming of *point d'Alecon* round the cuffs and the skirt of the coat. This material is both waterproof and dustproof, so that one can walk out into the garden in the heaviest rain to connect up the aerial or can delve down to inspect the earth without any fear of the consequences. The nether garments should take the form of pantaloons rather than of trousers. The latter are a delusion and a snare to the wireless man. I was just about to give an ancient pair of mine to Mr. Bugsnipp the other day when I happened to hold them for a moment upside down. From the turn-ups of the trouser legs there showered to the ground a collection of gridleaks, fixed condensers, terminals and B.A. screws. I had been missing these things steadily for months.

**Club Colours**

Neckwear is extremely important. On no account should a startling *cravatte* be worn when wireless work is in progress. One friend of mine, whom nothing will dissuade from adorning himself with the tie of the Ponder's End Shoveha'penny Club, cannot understand why it is that his valves are so shortlived. He does not realise that one sight of that terrible neckcloth is sufficient to cause even the hardest valve to blue-glow for a moment and then to die of a broken filament. By all means wear club colours, but see that they are restrained. Those, for example, of the Little Puddleton wireless club, besides being thoroughly dignified are too awful for words. You will find the Little Puddleton tie shown in colours on this page.\* The shape of the tie may be left to individual tastes. Personally I find that I obtain my best results when wearing a stock, though Mr. Hercy Parris tells me that since he has visited America he wears nothing but a bootlace tied in a bow round his neck when he is engaged on wireless work.

**Winter Wear**

For winter work, in addition to the Kosikap, a stout suit will be required. Here I recommend you to take a leaf out of the Arctic

\* No, you will not. We are always willing to oblige, but we really cannot run the risk of blinding half our readers.—Ed.

explorer's book. My tailor is engaged at present in building me a most *épatant* costume for the coming winter. It consists of a tightly-fitting tunic and pantaloons of sheepskin with the fur turned inside. The leather, which has been brought to a rich red brown finish to match the mahogany cabinet of my wireless set, is adorned upon the lapels of the coat and down the seams of the pantaloons with an embroidered *motif* of crossed gridleaks. The buttons are of ebonite, with the arms of the Little Puddleton wireless club embossed upon them. I venture to predict that this garment, which I call the Kumfsoot, will have a tremendous



On no account wear a startling cravatte.

vogue this season amongst wireless men. Blue prints and lay-out diagrams of both the Kosikap and the Kumfsoot, price one guinea each, can be obtained from Professor Goop, the Microfarads, Little Puddleton.

**The Snugtose**

Nothing remains for me to discuss now but footwear. Let us say at once that beetle-crushers with inch thick soles are completely out of place in the wireless room. Should you wear these things you have only yourself to blame if the valves utter protesting pongs as you stride across your den. For summer wear I recommend sandals of rose pink Russian leather garnished with green silk bows. The winter problem is a very serious one. Here again the Professor and I have come to the rescue of suffering wireless folk by designing the Snugtose footwear. These charming *souliers* are neat, effective and inexpensive. They are made on the lines of gum-boots, though canvas is used instead of rubber, for the uppers, with a lining of inch-thick felt. The foot part is of rhinoceros hide, the fur being once more turned inwards. The soles are of ebonite in order to insulate the wearer completely. I hope that my readers will take my words to heart, so that in future the vulgar will be unable to level accusations of slackness, carelessness and sloppiness in dress against us wireless men.

THE LISTENER-IN.



# THE HARMONY FOUR

By

PERCY W. HARRIS, MIRE.  
ASSISTANT EDITOR.



This article shows that Mr. Harris on his return from America has lost no time in adding one more to his series of interesting sets for the home constructor. The "Harmony Four" is a receiver of distinct novelty and adopts an ingenious use of terminals to cut out the note-magnifying valve. We venture to think this method will become as popular as the three-terminal arrangement for series or parallel aerial condenser connections—also originated by Mr. Harris.

QUALITY in reproduction, so eagerly sought by the home constructor of wireless sets, is not merely a matter of choosing the right kind of low-frequency transformer or the correct adjustment of resistance-capacity coupling. It is, to a much greater degree than is usually realised, also dependent upon the manner of using your valves.

If, for example, your high-frequency valve or valves have to be pushed to the verge of self-oscillation in order to get the signal you want, you are bound to get distortion, for working on this edge of oscillation is a prolific cause of trouble. Two years ago, when I produced the first of the "Transatlantic series" of receivers, the public was given a design in which the home construction of a simple and practical receiver, with two stages of high frequency was made possible. With these two stages of high frequency, distant stations could be heard without forcing the high-frequency valves too far, and

up. For some time I had been wondering whether it would be possible to still further simplify the design of a receiver with two stages of high frequency, and after a good deal of experimenting the "Harmony Four" has been produced. This receiver, as is illustrated and described in this article, has two stages of high frequency, a detector, and one stage of low-frequency amplification. It is both sensitive and stable, and although it has three tuning dials, instead of the two which characterise the "Transatlantic" series of receivers, it will not be found difficult to handle with a little practice. A feature of the "Harmony Four" is the method of high-frequency coupling,

### Two Couplings

The first valve is coupled by the neutrodyne-tuned-anode method, while the second utilises a high-frequency transformer with tuned secondary. There is but one neutralising control and no potentiometer, the neutralisation of the first high-frequency valve in this circuit arrangement being found sufficient to prevent self-oscillation and its accompanying troubles. Novelty is introduced into the low-frequency side by a new terminal arrangement which greatly simplifies the wiring and reduces the cost of construction. This terminal method can be adapted to any existing receiver with one stage of note magnification so as to enable the user to listen on the detector valve without the low-frequency stage, or to listen with the low-

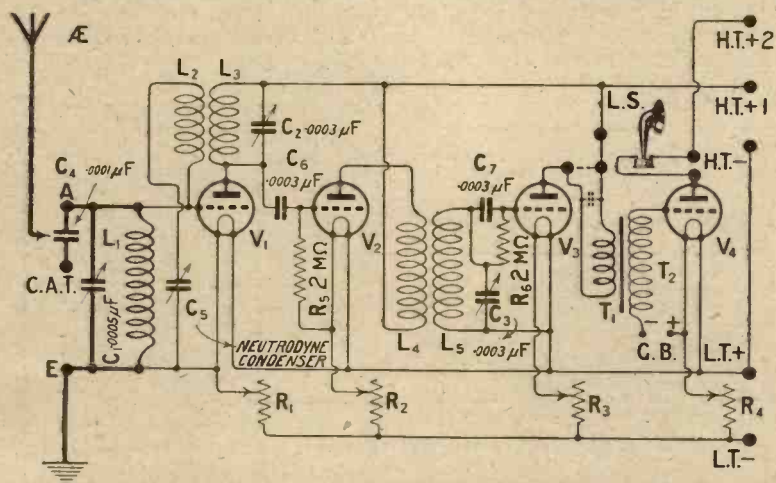

Fig. 1.—The theoretical diagram. The condenser across  $T_1$  is optional. The on and off switch is omitted for reasons of simplicity.

as a consequence the quality of reproduction of distant stations was noticeably better.

### Simplification

Later, in my modification of the Cowper neutrodyne-tuned-anode method, in which the plug-in high-frequency transformer was adapted, a new line of experiment was opened



frequency valve in circuit. Fig. 1. shows the theoretical diagram, from which it will be seen that by placing the telephones between the two terminals in the anode circuit of  $V_4$  they are inserted between the anode of the last valve and the high-tension positive, while the connection between the primary of the transformer and its particular positive high-tension terminal is made by the link between the two terminals shown joined by the dotted line. These are clearly indicated on the panel. By placing the telephones between the two other terminals, the primary of the low-frequency transformer is shorted and the telephones are then placed directly between the anode of the

detector valve and its H.T. supply. The great advantage of this method, apart from the simplicity of wiring and the saving of cost, is that the adjustment of voltage on the detector valve is not upset by the change. Many switching methods, in changing over from the low-frequency valve to the detector, place the voltage of the amplifier valve on the detector. This is a disadvantage when the amplifier voltage is considerably

the instrument so that trailing wires do not impede the user. On the aerial side there are three terminals, one for aerial, one for earth and one for C.A.T. condenser. In view of the inclusion of this condenser, it has not been thought necessary to incorporate a series arrangement for the aerial condenser, as on very long aerials, or in cases where it is desired to reduce the aerial damping, the C.A.T. condenser can be used. Normally

panel, has been adopted in the "Harmony Four." The vertical panel, as will be seen, carries three dials: the first, on the left, being for tuning the aerial circuit, the second for tuning the anode of the first high-frequency valve, and the third for tuning the secondary of the transformer which couples the second high-frequency valve to the detector. Immediately below the central dial will be seen the knob of the neutrodyne condenser, while the remaining four knobs control the filament resistances. An on-and-off switch enables the current from the low-tension battery to be turned off without disturbing the adjustment of the filament resistances, and on the right we see the five terminals of the new low-frequency change-over arrangement.

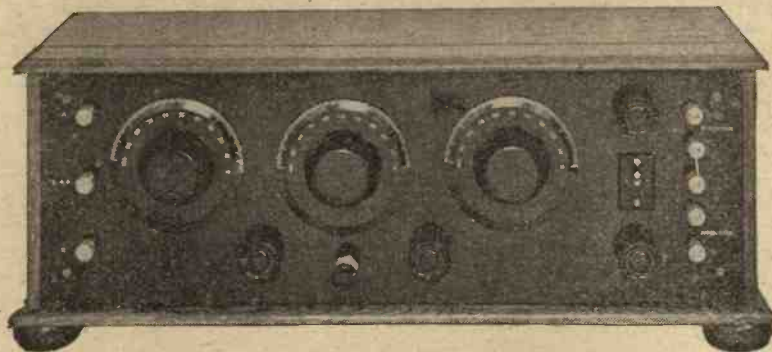

The front panel has a pleasing layout.

Behind the panel are arranged the various components required, special care having been taken with the layout of the set so as to keep essential wiring as short as possible. The whole instrument is mounted in an open cabinet, with lift-up top, so that the valves can be inspected and the coil and transformers changed with ease.

the instrument so that trailing wires do not impede the user. On the aerial side there are three terminals, one for aerial, one for earth and one for C.A.T. condenser. In view of the inclusion of this condenser, it has not been thought necessary to incorporate a series arrangement for the aerial condenser, as on very long aerials, or in cases where it is desired to reduce the aerial damping, the C.A.T. condenser can be used. Normally

the instrument so that trailing wires do not impede the user. On the aerial side there are three terminals, one for aerial, one for earth and one for C.A.T. condenser. In view of the inclusion of this condenser, it has not been thought necessary to incorporate a series arrangement for the aerial condenser, as on very long aerials, or in cases where it is desired to reduce the aerial damping, the C.A.T. condenser can be used. Normally

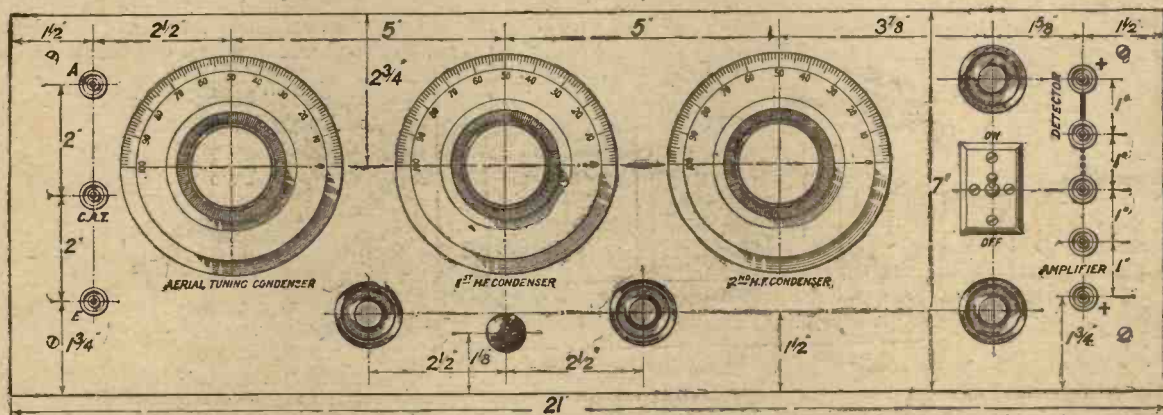

Fig. 2.—Dimensioned drawing of the front panel. A full-sized blue print of this panel may be obtained from the publishers, price 1s. 6d. post free. Ask for Blue Print No. 129a.

higher than that which should be used on the detector, and may upset the reaction adjustment. In my new terminal method the voltage on the two valves is not disturbed.

**Reaction Control**

It will be noticed upon examining the photographs of the instrument and the circuit diagram, that there

the tuning is quite sharp, but greater selectivity can be obtained by using a plug-in coil with a tapping on it, such as the Lissen X coil. The Igranic "Unitune" coupler can also be used if desired.

The popular "American" method of construction in which the valves and other accessories are placed behind the main control

**Components**

In the matter of components, you have a wide choice, and although following usual Radio Press practice the name of the actual component used in the set is placed after each item, any other good make advertised in this journal can be substituted.



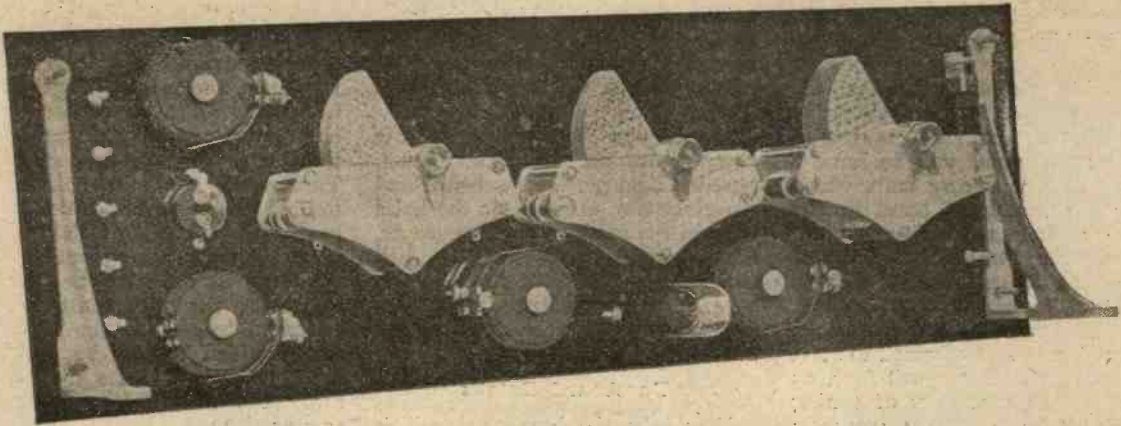

The back of panel components' mounted ready for wiring.

One panel of guaranteed insulating material, 21 in. by 7 in. by  $\frac{1}{16}$  in. or a  $\frac{1}{4}$  in. (Radion).

One cabinet, of the type illustrated, with lift up lid, to take the panel. It should be provided with a baseboard to fit. (Camco.)

Two supporting brackets to hold panel on baseboard. (Magnum.)

Two square-law variable condensers  $\cdot 0003 \mu F$ . (Igranic.)

One square-law variable condenser  $\cdot 0005 \mu F$ . (Igranic.)

Four filament resistances of a type suitable for the valves you intend to use. These can be of the now popular dual type. I have used the "Polar" bobbin rheostat, which by means of interchangeable bobbins allows the use of either bright or dull emitters at will.

Fifteen 4BA terminals.

One ebonite strip measuring 7 in. by 2 in. by  $\frac{1}{4}$  in.

One on-and-off switch. (Rothermel.)

One fixed condenser  $\cdot 0001 \mu F$  with clips. (McMichael.)

Two Dorwood Precision condensers with grid-leak clips  $\cdot 0003 \mu F$  each. Other types of grid condensers can be used if desired, but may occupy a little more room in the set.

Two grid-leaks, 2 megohms. (Dubilier.)

One coil socket for board mounting.

Six valve sockets. (Magnum.) If you are using dull emitters then four of these at the least should be of the vibratory type. For uniformity I have all six of this kind, but the sockets used for the neutrodyne unit and plug-in transformer need not be of the vibratory type.

One good quality L.F. transformer. (McMichael.) This par-

ticular type has clips for a fixed condenser across the primary, and one is shown in place in the photograph, but the set works just as well without this condenser, for which reason it is shown dotted in the circuit diagram.

One neutrodyne condenser. This can be of any of the well-known makes; that shown is the "Polar" old type. The new type "Polar" is just as suitable.

One neutrodyne unit for the broadcast band. (Any of the well-known makes.)

One H.F. transformer for same range. I have used several makes with equal success here. As they serve a different purpose they do not have to be matched with the neutrodyne units.

Four suitable valves. You have a very wide choice here, but I would recommend that the first two, whether they are bright or dull

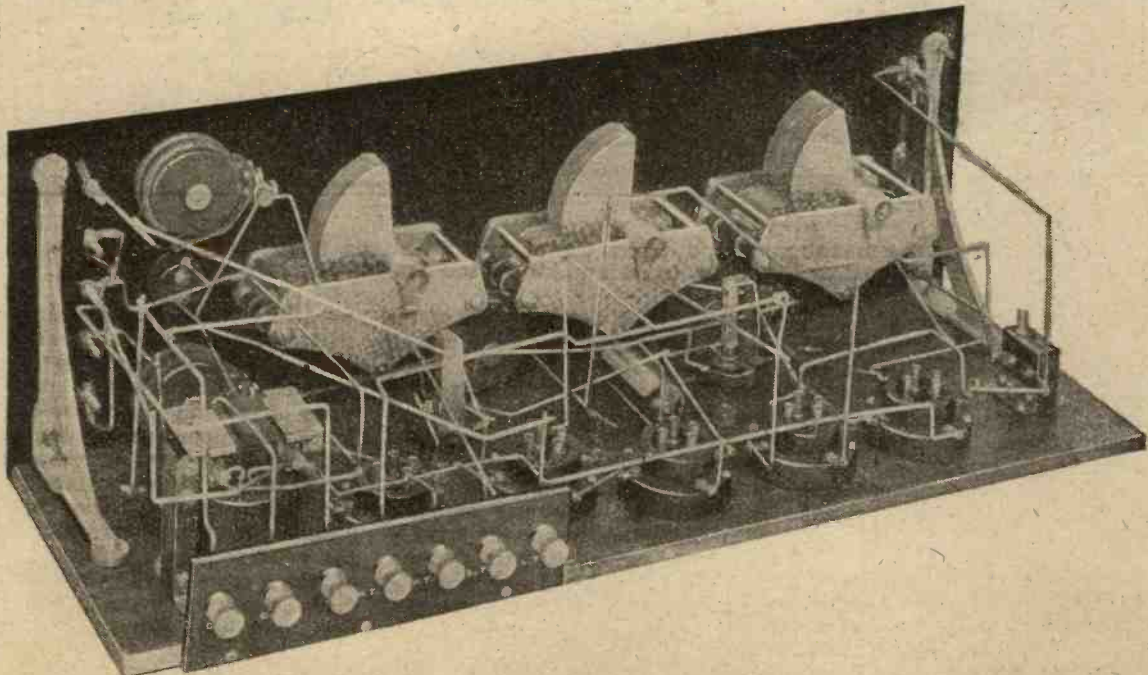

Notice how the wiring is arranged to avoid long leads and attendant complications.



emitters, should be of a type suitable for high-frequency amplification.

Suitable plug-in coils for the broadcast band. If you are using coils of the numbered variety, I would recommend you to have a 25, 35 and 50. Any coils which cover the broadcast band in the ordinary wireless set will work just as well here. For higher selectivity the Lissen X coil or the Igranic "Unitune" can be recommended, although if you are not experienced in handling sets it is as well to start off with the ordinary coil first, as owing to the sharpness of tuning introduced by these coils, you may have difficulty in picking up stations on the three tuning controls.

lishers, price 1s. 6d. each, post free. The on-and-off switch will need rather a large hole, but none of the others will be larger than  $\frac{3}{8}$  in.

When you have mounted the components on the front panel, stand it against the baseboard and ascertain the position for the holes to take the screws for the brackets. Mark these out very carefully, drill them and then attach the brackets by 4BA metal screws and nuts. Do not yet screw the brackets to the baseboard.

**Baseboard Details**

Now take the baseboard, which will be supplied with the cabinet, and lay out the parts exactly as

**The Terminal Strip**

The next step is to drill the small ebonite strip which carries the terminals, and mount it against the back edge of the baseboard, after having cut out a small strip from this latter in the manner shown. Three wood screws will be sufficient to hold this panel in position, as the baseboard will be a partial support for it. If the cabinet supplied is not cut away at the back to take the terminals, the opportunity should be taken to remove the necessary wood, which should be done by drilling two large holes and cutting away the wood with a key-hole saw or some similar instrument.

When the front panel, baseboard and terminal strip have been fitted

**THE WIRING DIAGRAM**

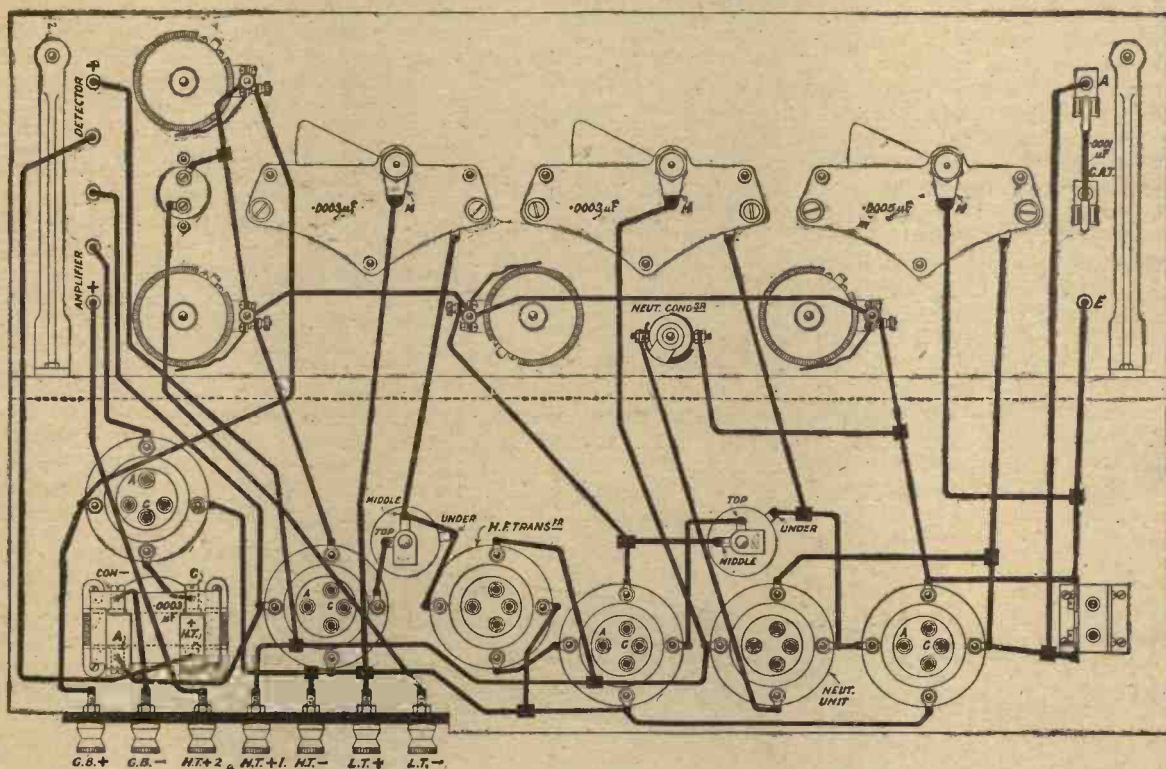

For simplicity the baseboard and front panel are drawn as if in the same plane. Blueprint No. 129b. is obtainable, price 1s. 6d. post free.

**Reception of 5XX**

For 5XX you will need a 150 coil for the aerial socket and two plug-in H.F. transformers covering 1600 metres (187kc.); these need not be matched as they serve different purposes in the set.

The fitting of the components on to the front panel will not present any difficulty, as practically all condenser makers now supply drilling templates, and the other holes can easily be marked out from the diagram, Fig. 2. You will be greatly assisted by the full-sized blue prints, obtainable from the pub-

shown. With the exception of the Dorwood condensers, these are all held in position by small wood screws. The condenser stands being tapped with a 4BA thread, are best secured by drilling two holes in the right positions and passing 4BA screws through the baseboard on the underside. The screws supplied with these condensers are usually just large enough to pass through a  $\frac{1}{4}$  in. panel and you will probably require slightly longer 4BA countersunk head screws for securing them to this wood baseboard. These are readily obtainable.

up with their respective component parts, take a smooth file and file the ends of all terminals to be soldered. The smallest possible trace of soldering flux should now be touched upon every point to be soldered and a good clean hot iron used to tin these points. Be particularly careful in tinning and soldering the small lugs attached to the valve sockets, for the material of which some of these sockets are made softens under the influence of heat, and you may have a loose contact there at a later time. Owing to the effect of heat on ebonite



it is just as well after all points have been tinned to tighten up the nuts.

**Wiring**

The wiring of this set may seem rather complicated, but is not difficult if tackled in the right way. You will notice that there is one wire which goes to all filament resistances and is attached to one terminal of the on-and-off switch. This can be connected up on the back of the front panel before this is mounted on the baseboard. I would also recommend you to fasten to the other terminals of each of the filament resistances a length of wire about 3 in. long. This should be made to project at right angles from the back of the panel. Similar projecting pieces should be attached to the tuning condensers and the two terminals of the neutrodyne condenser. If wires are joined up in this fashion it is a simple matter to cut off and make the soldered connections from these wires at a later time. If you attempt to join them in position after the front panel has been attached to the baseboard, you will find the terminals concerned are practically inaccessible. The panel can now be fastened to the baseboard and the wiring of the latter carried out with the aid of the diagrams in the most convenient fashion. The photographs as well as the diagrams will show you the general layout of the wiring, and I would recommend you to have your neutrodyne unit, transformer and valves in the sockets (burnt-out valves will do just as well for the moment), so that you can make sure that your wires clear them satisfactorily. Particular care in this regard is required when wiring up the audio-frequency end of the set, as the wires have been carefully placed to avoid fouling the last valve.

**Positions of Grid Leaks**

If you are using grid leaks and condensers of a different pattern, notice that in the first case the leak is connected between the grid and the filament, and in the second case across the grid condenser. Particular care must be taken to see that the neutrodyne condenser clears

the wiring at all points of adjustment. Notice too, that clearance should be left for any make of plug-in coil, for some are larger than others and you may desire to use a different type from that to which you are accustomed. In my design

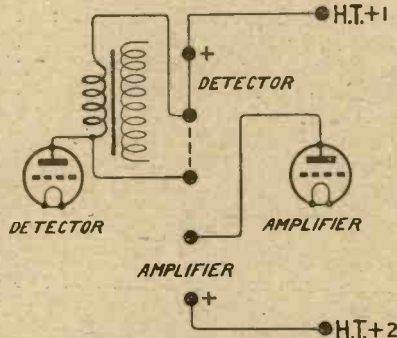

The new terminal arrangement for L.F. switching.

ample room has been left for the largest of these.

**A First Test**

When you have completed your wiring, make sure that all nuts are tight. Now turn your filament resistances to the "off" position, remove the valves, join up the low-tension battery and try a good valve in one

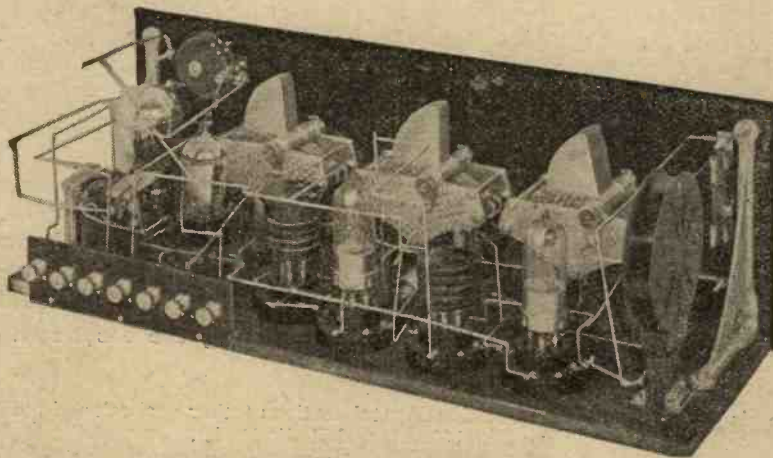

Details of the baseboard wiring.

socket after another by turning the filament resistances to the "on" position to see whether the valve lights and is properly controlled. When this is done, place your neutrodyne unit and transformer in position, short circuit the grid bias terminals for the time being by joining them with a piece of wire, connect up the high-tension battery negative and join the two high-tension positives together by a piece of wire. From one of these terminals (it does not matter which) take a lead to the high-tension battery and plug in about

50 volts. Of the five terminals on the right-hand side of the front panel join the second and third from the top with a piece of wire and connect your telephones between the two terminals marked "detector" (the two topmost terminals). Light up the first three valves and turn the last to the "off" position as you are not using it at the moment. Plug in to the aerial socket a coil suitable for the broadcast band with your aerial (say a No. 35), join the aerial to the terminal marked "A" and the earth to the terminal marked "E." Be careful to carry out these tests either before or after broadcasting hours, as the preliminary adjustments will cause a certain amount of radiation.

**Tuning Positions**

The tuning positions for given wavelengths are not identical on all three condensers—in fact they will always be different by several degrees. Set your middle dial at some arbitrary position such as say, 30, and move the first and third dials backwards and forwards, when you will probably find a point when a "popping" and rushing sound in the telephones indicates that

the set is in self-oscillation. Now slowly vary the neutrodyne condenser adjustment and on each new adjustment move your first and third dials backwards and forwards and see whether the range over which the set oscillates is reduced. Carry on the neutrodyne adjustment until a point is reached when you will get no self-oscillation at any position on the three dials.

This may sound rather a complicated process, but in practice it is quite easy. Once this position has been found the particular setting of the neutrodyne condenser can be left and will rarely need any attention.

**The Terminal Positions**

As soon as broadcasting starts you will have no difficulty whatever in picking up your local station and in tuning it in at the best strength on all three dials. By transferring the telephones from the terminals indicated to the two bottom terminals, by linking the two top



terminals together with a wire, and lighting up the last valve you will now have sufficient volume to operate a loud speaker at full strength.

Adjustment of the three dials will easily bring in many other broadcasting stations and if at any position of the condenser setting the set should go into oscillation, a slight readjustment of the neutrodyne condenser will be sufficient to cure it. If there still remains a tendency to self-oscillation reduce the high-tension voltage until it ceases.

**Sharper Tuning**

The volume and purity obtainable from distant stations from this set will surprise you, and, although you may find a little difficulty at first in manipulating three dials on a set which tunes rather sharply, the difficulty will soon disappear. If the tuning is not sharp enough for you you can increase it by using either a Lissen X coil or the Igranic "Unitune" coil

**Reception of 5XX**

For the reception of 5XX you will need a suitable coil, say, 150, and a couple of plug-in transformers for the 1600 metre wavelength band. The procedure for stopping self-oscillation here is somewhat different. You will not find any great effect from the neutrodyne condenser, and I have found the most satisfactory method is to keep the middle dial well out of tune, tuning on the first and third dials, and increasing the strength if it is not already strong enough (although it probably will be) by varying the central dial. This central dial will now give reaction control, for as you approach the tuning position for 5XX the set will come nearer and nearer to self-oscillation. The volume obtainable, however, of this station will be so great that I think in practically every instrument you will require to de-tune the set; working it on 5XX near the point of oscilla-

tion will only be needed by readers who are living in foreign countries.

**Results**

As reception conditions vary from night to night, from month to month, and are entirely different in different districts and with different aerials, a catalogue of stations heard on this receiver would scarcely convey the real merits to the average reader. I should, however, state that on an ordinary outdoor aerial it has brought in numerous Continental broadcasting stations at full loud-speaker strength, after dark, while, of course, the British stations all come in excellently. Daylight tests brought in several British and two

same purpose for all sets you use, thus saving expense.

For this reason Mansbridge condensers have not been incorporated in the present receiver. If you have not such a box, obtain two Mansbridge condensers of one or two microfarads, screw them down to a small board, and solder a wire from one lug of one condenser to one lug of the other. From this connection take a wire to the negative high tension terminal, solder flexible wires to the remaining two tags of the condensers and take one of these wires to each H.T. positive terminal. Without these, condensers the tendency to self-oscillation will be much greater and you may have difficulty in neutralising the set.

Normally you will use the aerial connected to the terminal marked "A" but on very large or poor aerials better results can often be obtained by joining it to the C.A.T. terminal.

**Use with Frame Aerial**

This set works excellently with a frame aerial, although it will require more careful neutrodyne adjustment to prevent self-oscillation. If in any case neutroding adjustment does not completely

check self-oscillation, an alternative method is to de-tune on the central dial as suggested for 5XX. Personally, I have had no difficulty in completely neutralising the set on all types of aerials. The set also works admirably with the smallest indoor aerial and should be of great convenience to dwellers in flats.

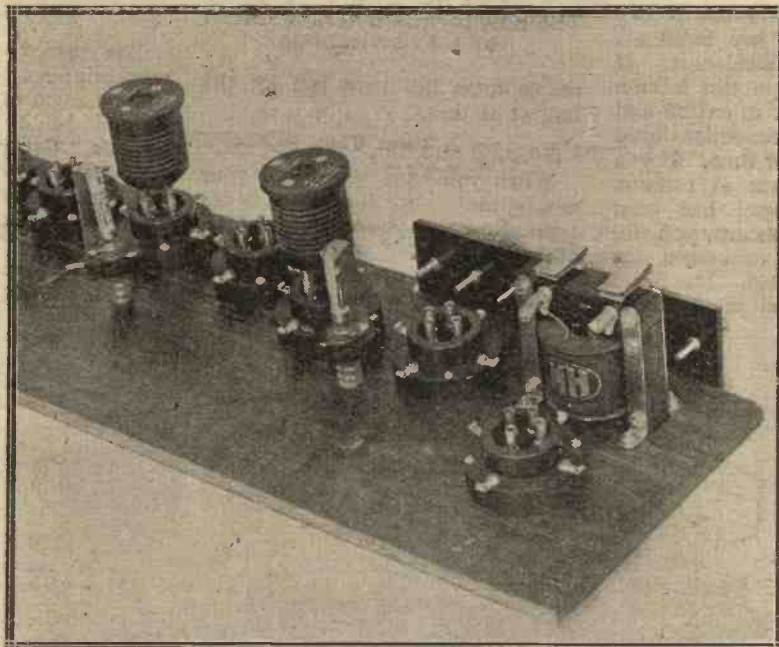

This photograph will help you in arranging the baseboard components.

or three Continental stations (other than Eiffel Tower and Radio Paris). In Wimbledon, 5XX works a loud speaker on an aerial consisting of 2 ft. of wire and no earth.

**Special Note**

It is essential with this receiver that the high-tension battery should be shunted by a Mansbridge condenser of 1  $\mu$ F. or more for each tapping. As most experimenters want to try a number of circuits I have for some time recommended the making up of a small box containing two or three Mansbridge condensers which can be connected across the high-tension battery when required. In this way, one or two Mansbridge condensers can be made to serve the

"Wireless"  
 SEPT. 15th  
 Price - 2d.



# Testing Anode Resistances

By G. P. KENDALL, B.Sc., Staff Editor.

*Circumstances sometimes prohibit the testing of anode resistances by the substitution method and in such cases the notes on this page will be helpful.*

WHEN instructions are given for the testing of a complete set circuit by circuit in order to locate a fault, it is usually recommended that the anode resistances (if present) should be tested by substitution: they are commonly mounted interchangeably in clips, so that it is a simple matter to slip one out and replace it with another, noting any change in the behaviour of the set thereby produced.

### An Awkward Situation

To be able to dismiss the anode resistances in this simple way, however, involves the possession of a spare one of approximately the correct value, and it is not always that this condition is fulfilled. Recently, for example, I had the task of locating a fault in a three-stage resistance amplifier, the nearest spare resistance being many miles away, and the experience suggested that the tests I used on that occasion may be worth publishing for the benefit of readers who may find themselves in similar situations.

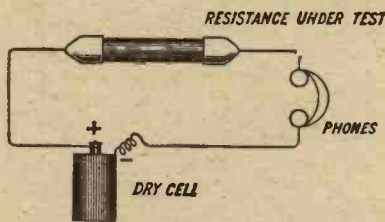

Fig. 1.—The Telephone Method.

### The First Test

The first thing to be done, of course, in testing a possibly defective anode resistance is to decide whether the end caps are making contact with the contents of the cartridge, *i.e.*, whether the circuit is broken altogether. For this test the invaluable telephones and dry cell method can be used, applying it directly to the ends of the suspected resistance.

### An Objection

It is best to remove the resistance from the set for this test, and the connections are then as shown in Fig. 1. On making and breaking this circuit quite decided clicks should be heard, and their absence

should lead to the discarding of the resistance. On the other hand, the obtaining of clicks of some sort should not lead to a hasty assumption that all is well with the component, since it is extremely difficult to say just how loud the clicks



A typical interchangeable Anode Resistance.

should be to denote that the resistance is of approximately the correct value.

### Test for "Frying"

Moreover, this test may not be conclusive when a partial break is developing inside the resistance, although if the "frying" stage has been reached it may be detected by raising the testing voltage to ten or fifteen volts (use a tapped H.T. battery) and listening carefully when the circuit is complete. Any really noticeable crackles or sizzles should condemn the resistance, but take care that all connections and contacts in the testing circuit are above reproach before deciding that the resistance is the offender.

### Limitations

A resistance may come through all the tests which we have just been considering apparently satisfactorily and yet be in actual fact defective. For example, one of the resistances in the faulty amplifier which I mentioned at the opening of these notes did not give any crackling or fizzling noises, and there were quite perceptible clicks in the telephones upon making and breaking the circuit. This resistance, nevertheless, was discovered by a more searching test to be in the process of breaking down, and possessed a resistance very much above the correct value.

### A More Searching Test

Evidently, some more decisive test is needed, and this may be found in the circuit illustrated in Fig. 2, which shows how a milliammeter may be used to obtain an estimate of the resistance of the component under consideration. The method depends upon the application of the relation known as Ohms Law, to enable one to deter-

mine the resistance in circuit from the amount of current flowing when a known voltage is applied. Taking the normal value of the resistance, a suitable voltage is chosen to cause a safe value of current to flow, such as half a milliampere. Thus, should the resistance be of 100,000 ohms value, if 50 volts are applied across its ends the desired current of half a milliampere is obtained.

### Testing Voltage

A high tension battery is used as the source of the testing voltage, but it is best to use quite a new specimen, in order that the voltage may be assumed according to the socket in which the plug is inserted, 54 volts being near enough to the desired 50 for practical purposes. If the battery is not a new one, its voltage should be measured by means of a voltmeter and the plug inserted in whichever socket gives the nearest reading to 50 volts. If the circuit is connected up with the specified 50 volts applied to it, the reading of the milliammeter will now enable a rough estimate of the resistance in circuit to be made. For example, if the reading is only a

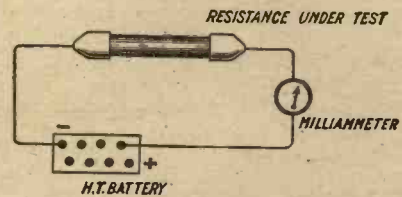

Fig. 2.—A more accurate method.

quarter of a milliampere we should know that the resistance must be of 200,000 ohms value, which, of course, is much too high a value for practical purposes. On the other hand, suppose the current were found to be one milliampere this would indicate that the resistance was of only 50,000 ohms, which is rather a low value, but would probably serve the purpose of a coupling unit fairly well.

**" WIRELESS. "**

Out on SEPT. 15th.

Price 2D.

Make sure of your Copy.



# Receiving Daventry

By A. D. COWPER, M.Sc., Staff Editor.

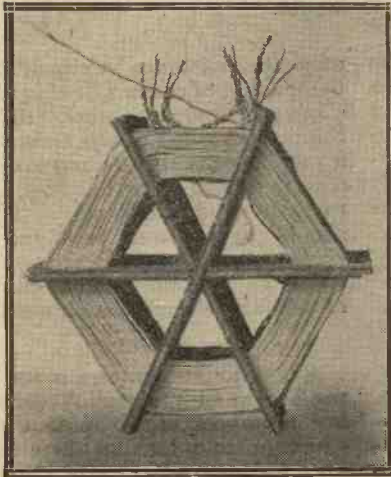

The former upon which the coil is wound is a development of the Harris X former.

In this contribution Mr. Cowper describes a low-loss inductance for use in 1,600-m. reception.



The coil is made so as to allow proportional crystal tappings to be used.

THE technique for really efficient reception of the long-wave high-power station of the B.B.C., the new 5XX, is of a very different order to that recommended in connection with short-wave transmissions. The opening of the Daventry station, and the promise of an alternative service that can be relied upon over an immense area, should result in a revival of interest in long-wave methods on the part of many listeners; and in districts previously badly served by the short-wave stations, many may find on a wavelength of 1,600 metres for the first time a possibility of really satisfactory reception. On account of the concentration of attention, hitherto, almost entirely on the higher frequencies for broadcast telephony transmissions, we (in Great Britain) have not had very much opportunity of determining experimentally what really constitutes an efficient "low-loss" 187 kilocycle receiving circuit, or, e.g., the best design for a tuning-inductance for use on this frequency.

### 1,600-m. Tuning Inductance

The conditions to be fulfilled by a 1,600-metre tuning coil are of a different type from those to which an efficient short-wave inductance must conform. In default for the moment of elaborate measurements to determine what is really the optimum design, one will not go far

wrong in winding a 1,600-m. coil of No. 22 d.c.c. wire in a narrow slab form which gives small distributed capacity, and which at the same time lends itself to easy winding and to compact arrangement. Several narrow slab-coils can be mounted fairly close together (far enough

apart, of course, to keep down the internal capacities and leave reasonable air-spacing); the simplest way to effect this is to make up a multi-slab coil on a "paddle-wheel"

former—developed from the Harris X former—in the form of a hexagonal cross or star of slotted strips of ebonite or dry ply-wood, which are each deeply notched so as to fit together in this manner.

Using a former made of three such strips, 5½ in. long and 3 in. wide, each with 10 slots (cut with a hack-saw blade) about 1½ in. deep, at each end, 20 turns of No. 22 d.c.c. wire can be wound in each slot, passing the wire from the filled slot to the bottom of the succeeding slot for the next slab, and so on, until full.

### Tappings

The result is a fairly compact 200-turn coil, which certainly shows a moderate H.F. resistance, and will tune to 1,600 m. with a .0003 μF parallel tuning condenser in a suitable circuit. For use in the most efficient type of crystal receiver, *tappings* are taken (by forming long loops which are left projecting when winding) at every 20 turns beyond the 40th, for crystal-tapping, and at every 10 turns from the 120th on for both aerial and crystal-tapping points. These are brought to two suitable stud switches on the panel; 9-points for crystal-tappings and 8 or 9-points for aerial-tappings.

### Crystal Reception

The simplest crystal receiver is, of course, the type indicated in Fig. 1, where a No. 150 or 200 coil

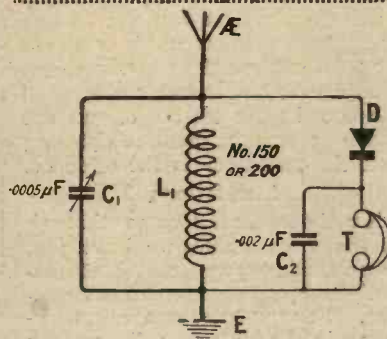

Fig. 1.—A simple crystal circuit using direct coupling

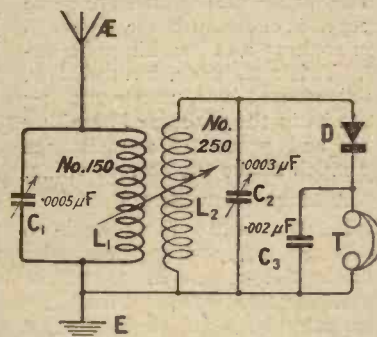

Fig. 2.—A typical loose-coupled crystal circuit.



(according to aerial size) is used in conjunction with a parallel tuning condenser of, e.g., .0005  $\mu\text{F}$  maximum capacity. This combination is occasionally replaced by a large variometer; very few instruments have sufficient inductance range, however, to reach 1,600-m. on an ordinary aerial without loading-coils, which latter are at best an unsatisfactory compromise, and rarely allow of really accurate tuning on the long waves when used thus. A better arrangement is the conventional long-wave loose-coupled circuit, Fig. 2. A two-coil holder is used with a No. 150 (or 200) coil as primary, and a No. 250 coil as secondary, with .0005  $\mu\text{F}$  and .0003  $\mu\text{F}$  tuning condensers respectively. This gives slightly better signal-strength than Fig. 1 in some cases, but involves three tuning adjustments; the selectivity is a little better than that of Fig. 1, but the tuning is, in practice, actually rather flat.

**Crystal Tappings**

In order to get really sharp tuning, and to be able to make the

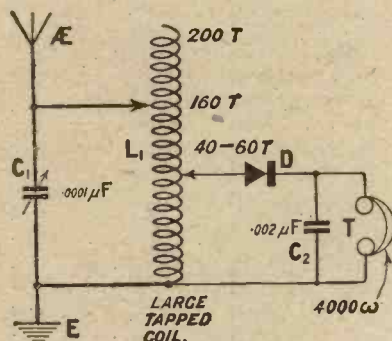

Fig 3.—The circuit used by the author in his experiments.

fullest use of an efficient, low-resistance aerial-earth system, the principle of proportional crystal-tapping, which proves so effective in favourable cases on the shorter waves, should be available here. The tapped paddle-wheel coil is therefore suggested; the aerial is connected to whatever point experience shows to give best results when combined with the very minimum of parallel tuning capacity; for this reason only a fine-tuning-condenser of .0001  $\mu\text{F}$  maximum is required. The crystal is connected across just so many turns of the inductance, by its tapping switch, that the best signal-strength possible is obtained; then we have the damping effect of the crystal properly balanced against the aerial-resistance ("proportional tapping")

so as to give the maximum available signal energy.

**Large Aerials**

It is surprising sometimes how few turns this needs with a good low-resistance aerial. A large double

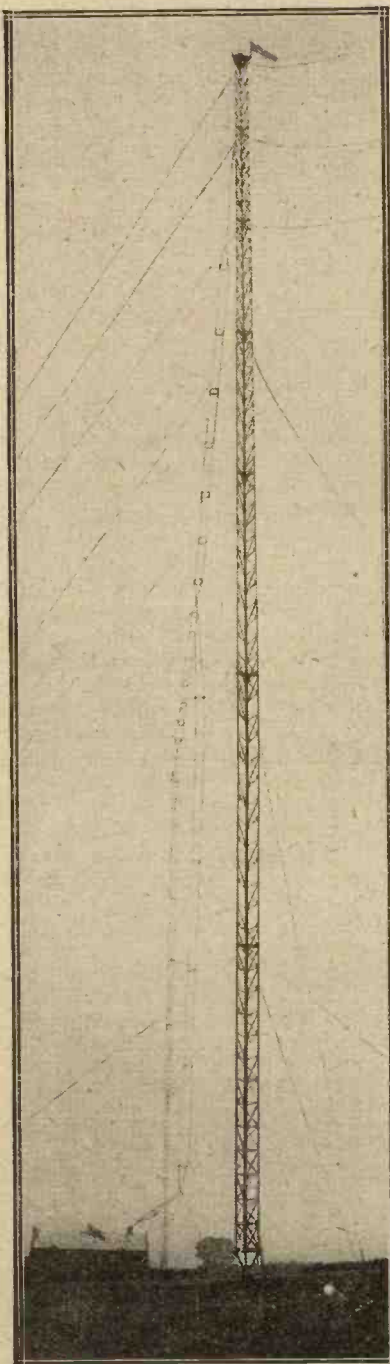

One of the 500-foot masts at the Daventry station. The power-house may be seen on the left.

or triple aerial is actually an advantage on 1,600-m., instead of the reverse, as on the short waves; for a reasonable amount of in-

ductance (without a great deal of idle parallel tuning capacity) suffices to tune it; and by proportional crystal-tapping the best advantage can be taken of the available power.

**Observations**

Some observations made in outer N.W. London shortly after the opening of the Daventry station will illustrate these points: a large, high, triple-wire (sausage) aerial, and an alternative small low single-wire one of only .0002  $\mu\text{F}$  capacity were used, in a fairly good location. The No. 150 coil of standard make in circuit Fig. 1 gave about 13 microamperes rectified current with a good galena crystal, on the large aerial; Fig 2. circuit, with coils Nos. 150 and 250, gave 15 to 16 microamperes.

The paddle-wheel coil, with 160 turns in the aerial circuit and about .0003  $\mu\text{F}$  parallel fine-tuning capacity, and with only 60 turns tapped off for the crystal, gave about 24 microamperes with 4,000 ohm. 'phones in use; later on in the evening this rose to 27 and 30

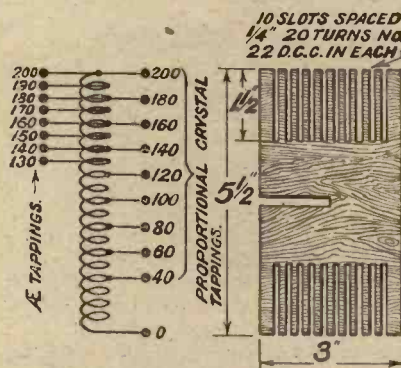

Fig. 4.—Constructional details of the coil.

microamperes, indicating excellent 'phone reception. A Weston galvanometer alone in circuit registered 35 microamperes, and on an ordinary milliammeter the rectified current gave a visible deflection. A crystal tapping at turn No. 40 gave practically the same reading; No. 80 turn showed a fall to 22.5 from 25 microamperes; the whole 160 turns in use gave but 15.5 microamperes; or little better than loose coupling. The same coil used as a loose-coupled secondary (Fig. 2) showed 15 microamperes; this was not improved by moving the crystal tapping point from the 200th turn downwards.

**Results on a Small Aerial**

On the small single-wire aerial the readings were 1.5 microamperes



direct coupled; and 3.5 (later rising to 5) microamperes with the proportionally tapped paddle-wheel coil. This indicates fairly poor crystal reception, but audible. With the tapped coil there was no difficulty with jamming by the local station, so much does this method sharpen up the tuning: on the low aerial 2LO was not heard at all; on the very high aerial (on which this station gives as much as half a milliampere under favourable conditions when tuned in on a low-loss short-wave crystal receiver) a faint murmur of London was audible during the intervals in the Daventry programme; but it was possible to turn from Bach to banjo solo at will, in the alternative programmes, with ease and comfort.

**Valve Reception**

Conventional direct-coupled and loose-coupled circuits with three-coil holders call for no comment here; the coil-numbers and other details have been frequently given in other connections. Those who find a degree of selectivity necessary, however, yet have not a three-coil holder available—or find the simultaneous quadruple adjustment required by the latter circuit rather trying—might find in the capacity reaction circuit shown in Fig. 5 a useful compromise. The coupling of the A.T.I. and secondary coil (sizes Nos. 150 and 250 as before) need not be varied continuously whilst tuning, but set moderately loose and left alone; the tuning of the secondary is fairly flat, though depending on that of the A.T.I. to some extent; reaction control is very smooth if a large radio choke and a small reaction condenser be used.

**Semi-Aperiodic Aerial Coupling**

A little less efficient as to signal strength, but a good deal simpler to handle, is the capacity reaction circuit with semi-aperiodic aerial coupling shown in Fig. 6. As before, a large choke and a small reaction condenser are essential for real

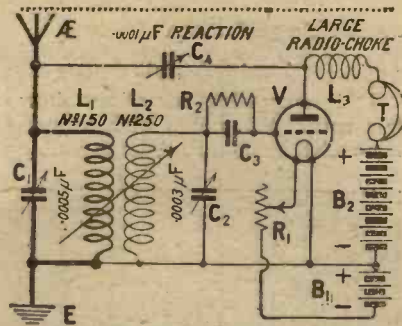
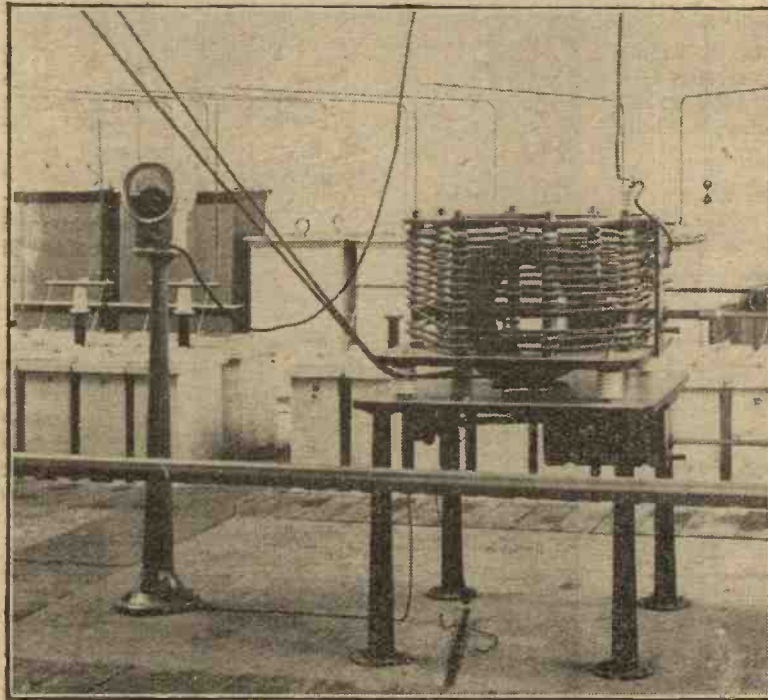

Fig. 5.—A simple circuit which gives a smooth reaction control.

efficiency and easy tuning. The primary (and reaction) coil is



A close-up view of the aerial tuning arrangements at Daventry, showing the aerial ammeter on the left. The instrument has a double scale with readings up to 60 or 120 amperes.

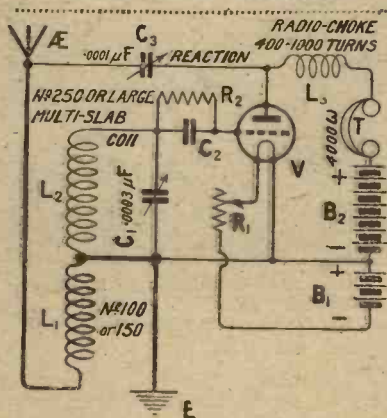

Fig. 6.—A circuit which is very easy to operate, the aerial circuit being untuned.

fairly close-coupled to the grid inductance, and then left severely alone. It should not be sufficiently large to tune the aerial to a wavelength too closely approaching that of reception.

The same paddle-wheel inductance, minus theappings, can be used with advantage in circuit Fig. 6. As primary either a commercial No. 100 or 150 coil, according to the aerial size, can be used; or a special basket coil of, e.g., No. 26 d.c.c. of about this number of turns can be made, and stripped off until, on trial, it does not cause any blank zones for easy reaction, i.e., does not tune the aerial within the range sought. The primary is placed close to the large paddle-wheel coil; the tuning is very simple on the one secondary tuning condenser, following up with fine reaction. The latter is very smooth.

With an additional valve as a note magnifier, the L.F. transformer primary inserted in place of the 'phones, using an R and small-power valve, and Lissen radio-choke, with Igranic No. 150 coil primary, this gave good powerful loud-speaking in London on a large aerial, and quite fair loud-speaking on a small aerial; on the 'phones

Daventry was readable without either aerial or earth. Radio-Paris was also read on the single valve without interference from Daventry, nearly at the maximum of the 0.0003 μF tuning condenser. Very little reaction-condenser capacity was needed, and there was no interference by the local short-wave station.

**Experiment**

As a matter of interest much experiment may be undertaken by readers with a view to obtaining loud signals from the Daventry station, and once that interest is created very pleasing results will soon follow upon their efforts







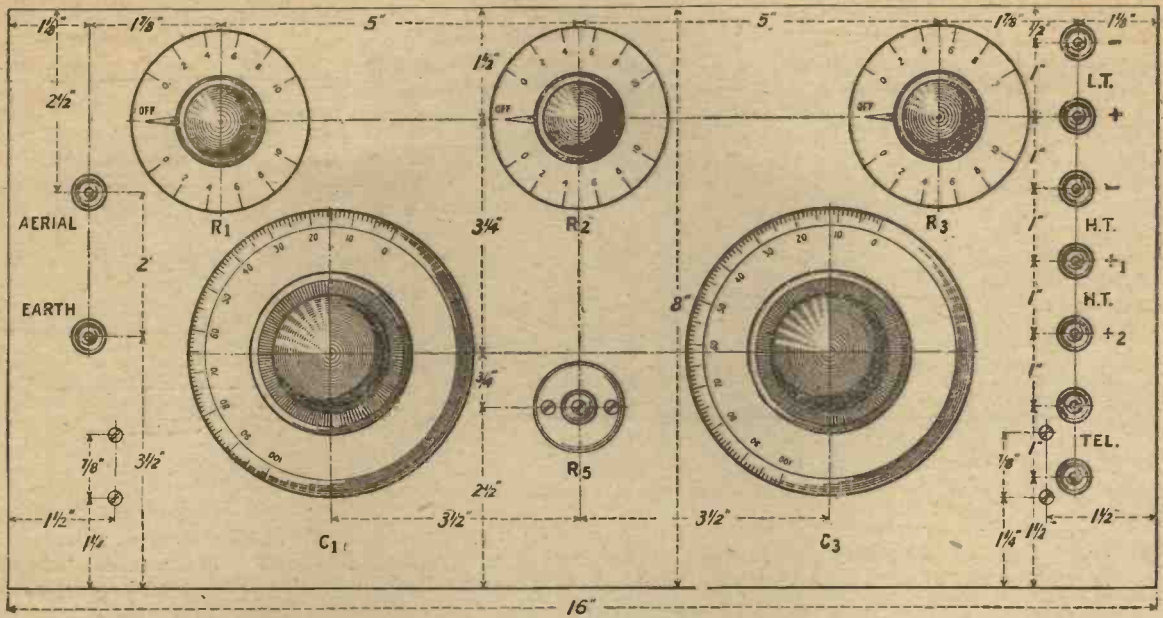

Fig. 2.—The layout of the panel is both simple and symmetrical. Blue Print No. 126a. Price 1s. 6d. post free.

lay-out as given is the result of very careful experiment with a view to eliminating losses on the one hand, and giving easy control of reaction over the whole range on the other. The positions of the various components in relation to each other should be treated with every respect, particularly those which form the grid and reaction circuits.

**Radio Chokes**

If the external battery connections to the set are long, meaning those leads which go to the low and high tension batteries, it is possible that some difficulty may be experienced in making the set oscillate in a smooth and easy manner, particularly if the leads are twisted. Should this difficulty

be met with, then it is recommended that small air core chokes of some forty turns of No. 22 d.c.c. wire wound round a lead pencil be included in each of the leads, when the trouble will be found to have been overcome. The lead pencil should, of course, be pulled out after the chokes are wound.

It may be found in the case of

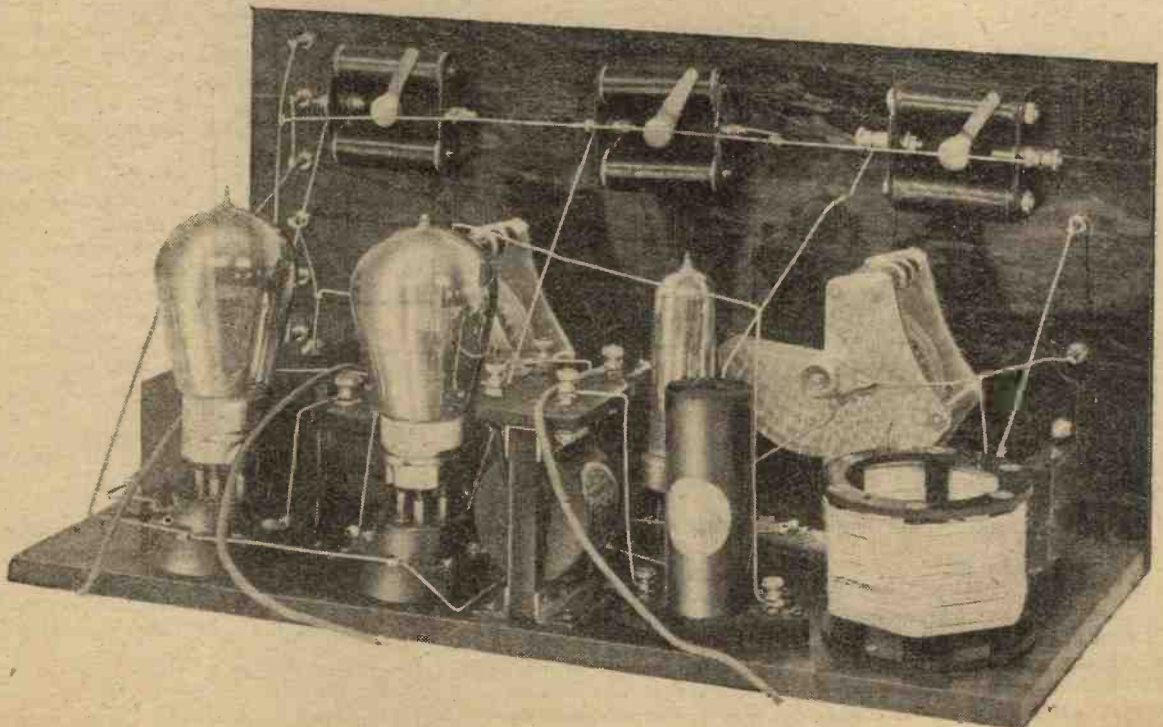

The connections to the coil are kept short and are well spaced. The long cylindrical component next to the coil is the H.F. choke.



some aerials that in the course of tuning there is one particular setting upon the grid tuning condenser at which the receiver will not oscillate; on the other hand, this failure of the set to oscillate may prevail over several degrees of the condenser dial. In either case, however, this condition of things is indicative of the fact that the grid circuit is tuned to the natural wavelength of the aerial circuit.

**Choice of Components**

When choosing components for short wave reception even more care is called for than in the case of broadcast reception upon the 300 (999.4 kc.) to 500 (599.4 kc) metre band, the reason being that if any one component which is used in the grid or plate circuit of the detector valve is poor, then the receiver will fail to give satisfactory results with regard to oscillation. Though it

**A Warning**

Should the reader decide to build a set exactly to the specifications given herein the actual components which go to make the set as illustrated are given later. This list does not necessarily mean that only these components may be used before satisfactory results may be obtained, but the information is given to readers as a guide to what is actually incor-

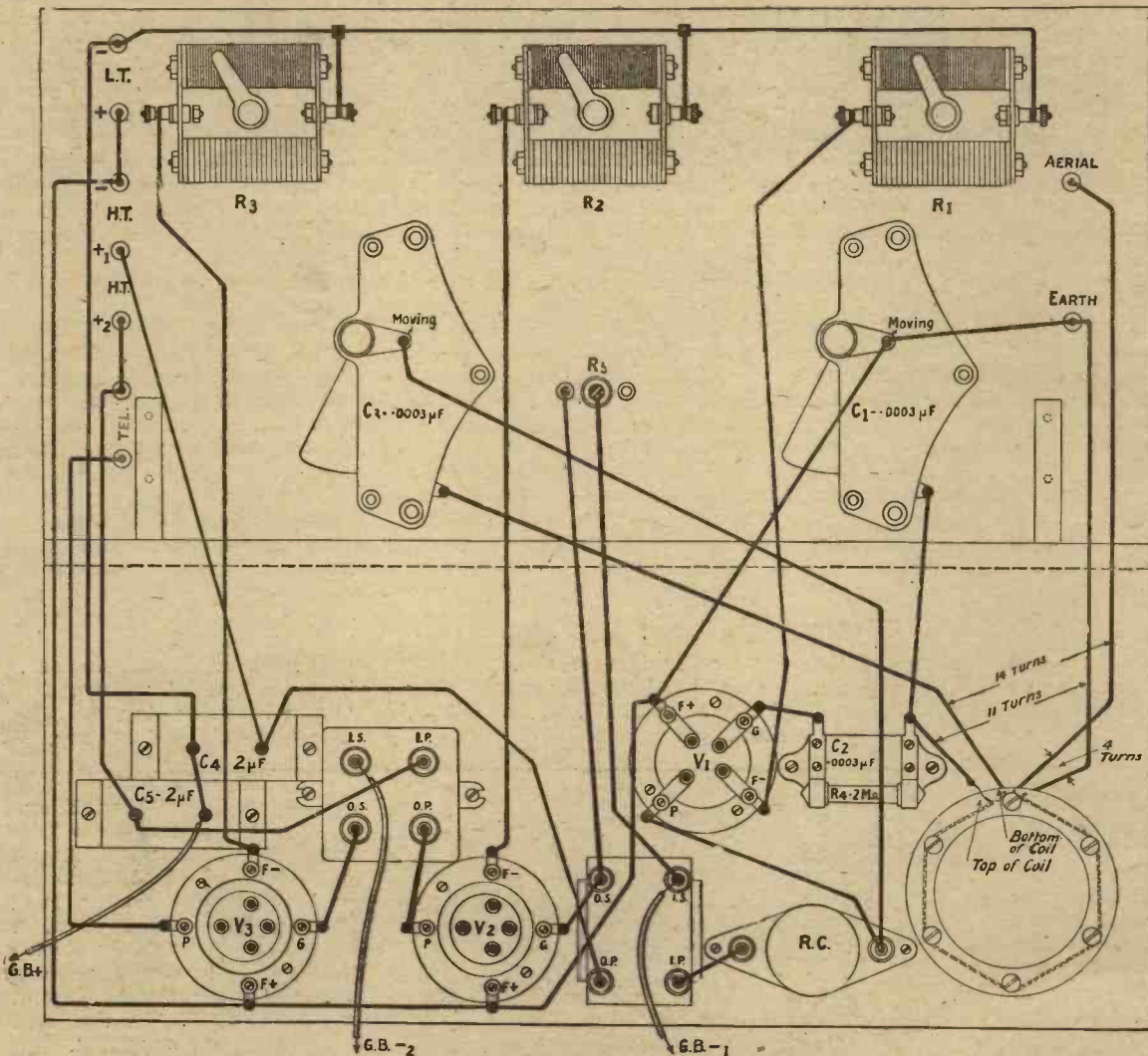

Fig. 3.—This wiring diagram should be followed in detail. Note the connections to the coil. Blue Print No. 126b. Price 1s. 6d. post free.

Should this spot occur at a position upon which it is desired to receive, then a small coil or fixed condenser should be added in series with the aerial, when the difficulty will be overcome. Owing to the temporary nature of the adjustment, the component may be connected outside the set between the aerial terminal of the receiver and the lead-in.

will be at once recognised that this remark applies to all receivers, it nevertheless applies with greater force where short wave receivers are concerned. With regard to the components in the remainder of the circuit these should also be carefully chosen if the best results are desired, a warning which is common to every receiver.

porated in the original receiver. In the matter of variable condensers these must necessarily be of a good low-loss type (there are now several obtainable) and the radio choke must be one having small self-capacity.

**The Coil**

As previously mentioned, this is wound upon a low-loss former, and



after securing the wire by means of threading through the holes provided, leaving about three inches spare for connecting purposes, eleven complete turns are wound after which a tapping is made by making a loop and twisting in the usual manner.

When this tapping is made four more turns are wound, when another similar tapping is made. Still without cutting the wire, fourteen further turns are wound, whereupon the wire is broken,

some readers may find that with the fourteen-turn plate coil, the receiver is a little too prone to oscillate, spoiling thereby the

smooth reaction control usually associated with the Reinartz circuit. Should this condition make itself manifest then it is recommended that two or more turns be removed from the coil, after first making certain that their removal is really desirable.

Tried on another aerial which is known to be quite average, the receiver certainly oscillated more freely than when connected to my own, though not in such a way that control of reaction

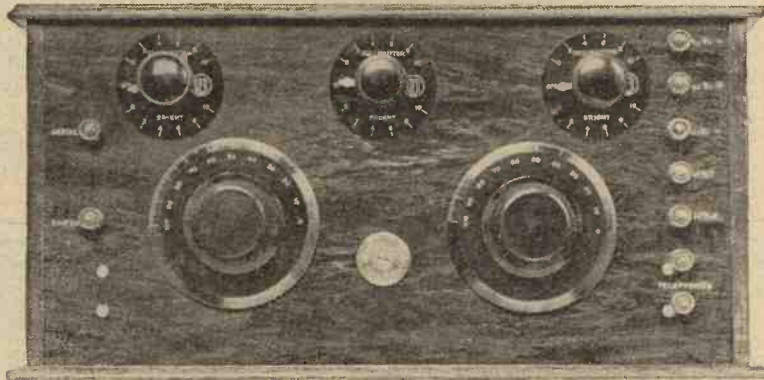

All the controls for operating the receiver are situated in a convenient manner upon the panel.

COMPONENTS REQUIRED

One cabinet and baseboard of a suitable size to take the panel as given below. The cabinet illustrated is the "All-Concert de Luxe" type (Camco).

One Radion mahogany panel measuring 16 in. by 8 in. by 3/16 in. (American Hard Rubber Co., Ltd.).

Two pieces of wood measuring 2 in. by 2 in. by 1/2 in. (These are used as brackets for supporting the panel, at the same time securing it to the baseboard.)

Nine terminals. (Those in the set are oxy-copper finished, supplied by Grafton Electric Co., Ltd.)

One low-loss coil former 3 in.

diameter by 3 in. long (Collinson's Precision Screw Co., Ltd.).

Two variable square-law condensers, each of .0003  $\mu$ F capacity (Igranic Electric Co., Ltd.).

One fixed condenser, with grid leak clips, of .0003  $\mu$ F capacity (Dubilier Condenser Co. (1921), Ltd.).

One grid-leak of 2 M $\Omega$  (Darco).

One "anti-pong" valve holder (Bowyer-Lowe Co.).

One radio frequency choke (Lissen, Ltd.).

One low frequency transformer (Power Equipment Co., Ltd.).

One low frequency transformer (Fuller's United Electric Works, Ltd.).

Two "Vibro" valve holders (Burne-Jones and Co., Ltd.).

Two fixed condensers each of 2  $\mu$ F capacity (Telegraph Condenser Co., Ltd.).

Three dual rheostats (Radio Instruments, Ltd.).

One variable anode resistance (Watmel Wireless Co., Ltd.).

Packet Radio Press panel transfers.

Quantity of No. 22 d.c.c. wire. Quantity of No. 18 tinned copper connecting wire.

One yard V.I.R. flexible wire.

Two black wander plugs.

One red wander plug.

One nine-volt grid battery.

leaving about 3 in. to spare, and two twists are made round one of the rods of the former to prevent the coil from unwinding. The resulting coil will be seen in Fig. 4.

The Plate Coil

Unfortunately, the aerial with which the author has to carry out most of his work is for some unknown reason possessed of very high resistance, in spite of the fact that every precaution has been taken to remove the defect. In view of this

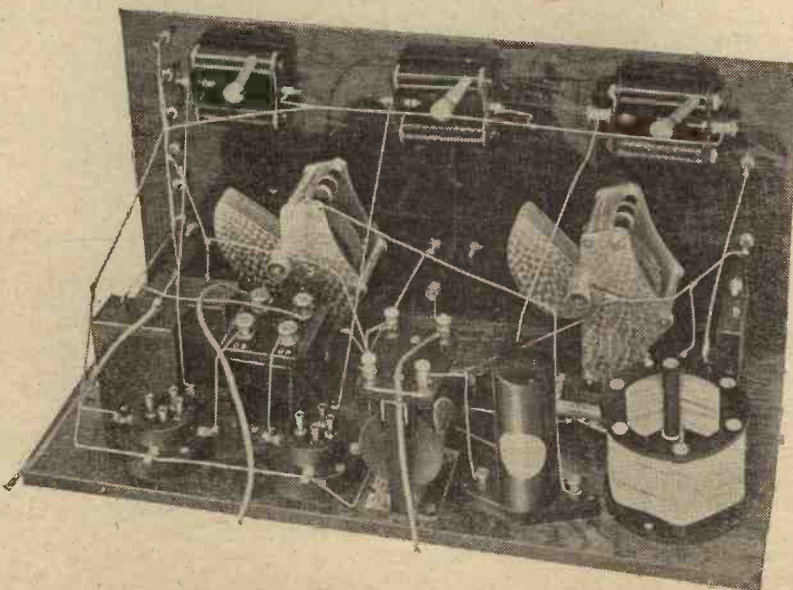

The wiring of the receiver is well spaced and the more important leads are kept short

left anything to be desired. Though readers may find that there is no difficulty in this direction, the remedy given will simplify matters should they meet with the trouble suggested.

Mounting Components and Securing the Panel

All the "variable" components are mounted upon the panel, as may be seen from the photographs and in the illustration which shows the front of the set; the condensers on the left and right



are the grid tuning and reaction condensers respectively.

The panel is secured to the baseboard by means of the two wooden blocks mentioned in the list of components, the reason for using these in preference to the usual brackets being in order to eliminate as much unnecessary metal in the receiver as possible. The coil is secured to the panel by means of a small brass screw passing through the lower ring of the former. The relative positions of the various components, both upon the panel and upon the baseboard, are indicated in the diagram illustrating the general layout of the set, and it cannot be too greatly emphasised that departure from this layout is not to be recommended.

do, it will be found that better results will be obtained by using valves of a special type. In actual tests made with the receiver during the reception of the short wave station operated at Schenectady, New York, the following were used in turn as the detector with pretty much the same results, but all decidedly better than those obtained with the ordinary "general purpose" type: B.T.H. B<sub>4</sub>, D.E. 3B., D.E.4., D.E. 5B and the French Radio-micro .06 valve. In the case of the B<sub>4</sub>, D.E. 3B., D.E.4 and the French .06 valves an anode voltage of 50 appeared to be ample in that no difference in results was observed upon increasing this voltage. In the case of the D.E. 5B., however, an anode voltage

**Operating and Testing the Receiver**

For the successful operation of the receiver, the reader should pay due attention to giving the receiver a thorough test before attempting to receive the American telephony stations, and this may be done by connecting the accumulator to its proper terminals and first testing out the filament lighting circuit, seeing that each filament resistance controls the brilliance of its particular valve; joining up the H.T. and grid-bias batteries in their respective positions, observing my previous remarks about maker's instructions as to voltages, connecting the aerial, earth and telephones to their respective terminals and then proceeding as follows:—

Fig. 4.—Details of the connections to the coil. The top end or beginning of the winding is connected to C<sub>1</sub> and grid condenser, while the end of the winding is connected to C<sub>3</sub>.

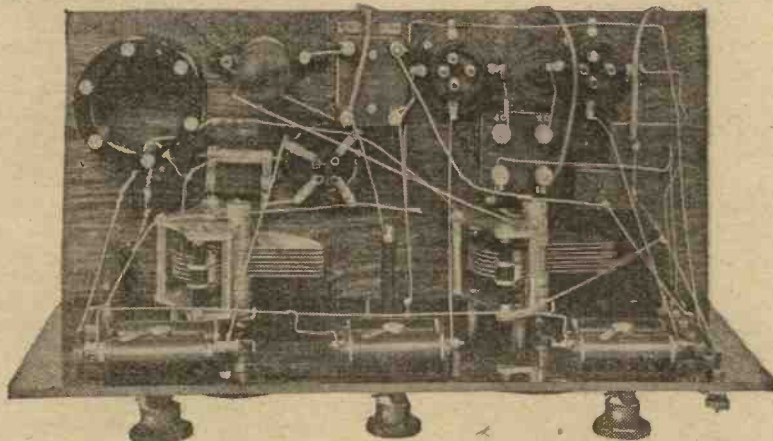
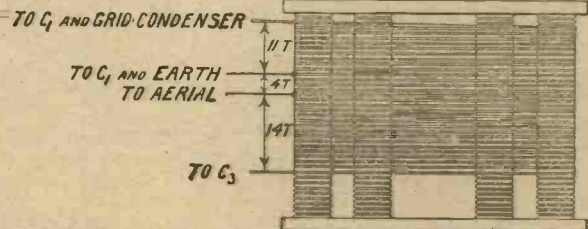

The wiring of the components which are secured to the baseboard may be followed from this photograph. Note the short leads which connect the grid coil in circuit.

**Wiring**

It will be seen from the photographs that ordinary No. 18 tinned copper wire is used for connecting up, and the reason why this wire was chosen instead of the popular "square rod" is that it enables the connections between points to be kept short, meaning that the wiring may be kept consistently efficient and well spaced without recourse to making right-angle bends. All connections should, of course, be soldered.

**Valves to Use as Detector**

It will be understood that this receiver is designed for use with the ordinary four-pin type of valve, and though actually any of the "general purpose" valves will

of 72 appeared to give the best results.

**The L.F. Stages**

As a separate H.T. positive tapping and grid-bias connections are provided for the low frequency stages, the valves used in this part of the circuit may be of the special L.F. types if desired, the anode voltage being raised to 120 volts if required, suitable grid bias being applied to suit the latter voltage. In choosing these L.F. valves readers should comply in detail with the maker's instructions as to the correct anode and grid bias voltages to be used, as by so doing they will find that best results are thus obtained.

With the valves lighted to a suitable brilliance and with the grid tuning condenser set to its zero position, the reaction condenser should also be turned to its zero reading and then slowly turned towards the higher end of the scale until the receiver is just oscillating. Once this condition has been established then the two condensers, grid tuning and reaction, should be turned simultaneously but very slowly, the grid tuning condenser being turned slightly faster than the reaction condenser. In this way it will not be long before a C.W. station (probably an amateur) is picked up, whereupon the best results should be tuned for by means of the grid



## THE AMERICA THREE—Continued.

tuning condenser, and final re-adjustments made upon the reaction condenser. The tuning of this first station is typical of the method of handling the receiver and should be practised several times before attempting to pick up the long distance telephony stations. Once the operation of the receiver is thoroughly mastered then reception of short wave telephony may be attempted, though it must be remembered that for the reception of this the receiver must be just off the oscillating point, otherwise speech or music will not be recognised. At the present time of the year the best time to attempt this work

station sending ABC at intervals and signing off with the call sign WIR; this station is New Brunswick, N.J., and according to the August issue of *Q.S.T.* is working on 74 (4052 kc.) metres. This information will give some indication of "position" to those readers who have acquired the habit of reading slow Morse. Further assistance in calibrating the receiver will be given by careful listening to amateur transmitters, who very often give their wavelength during the transmission.

### Fading

When the handling of the receiver has become a commonplace opera-

tions signals were remarkably good, speech being perfectly clear, only a word being lost now and again as a result of a heavy atmospheric.

### Results

Probably the most successful results obtained recently were those on July 31st, at 11.10 p.m. (B.S.T.), and August 1st, at midnight, when Schenectady was received at "small room" loud-speaker strength but badly spoiled by atmospherics. At approximately the same time Pittsburgh was also good, though not quite so strong.

### An Unknown Station

At 2 a.m. (B.S.T.) August 1st conditions improved considerably, in that atmospherics were less fierce and in between periods of fading, signals from both stations were at very fair loud-speaker strength. At about the same time another telephony station was also received with the grid tuning condenser set at zero, and thought it was possible to recognise the transmission as being telephony it was not possible to understand it.

### Time Difference

Taking into consideration the difference in time between this country and America, and the question of light hours, the results obtained during these recent tests indicate that there are few nights when at least some sort of result will not be obtained, though whether or not signals will always reach loud-speaker strength is, to use a well-known phrase, "in the lap of the gods."

### Improving Conditions

At the time of writing the present article, the main difficulties which have to be met are atmospherics and fading, and though as time goes on the atmospherics will gradually get less, the question of fading is always a speculation; nevertheless there will be times when signal strength is such that the telephones may be changed for the loud speaker with very pleasing results. Those readers who have a knowledge of the Morse code will find in a receiver of this type a marked interest. It may be said that on any evening hosts of amateur transmitters of all countries may be heard working with each other upon wavelengths around 70 metres, and a comparison of the relative signal strengths will indicate whether the night is good or bad for long distance work.

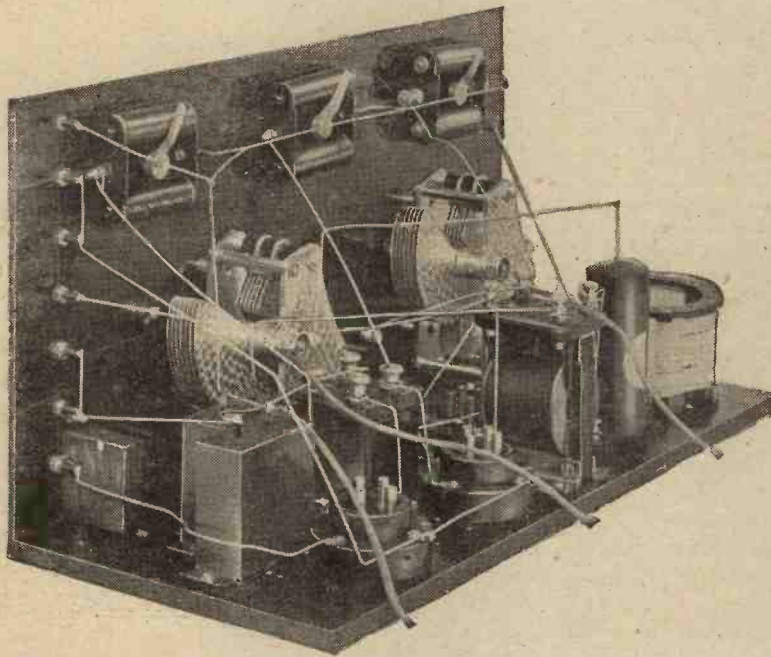

Two large condensers are connected across the batteries, one condenser being across each tapping.

is after 11 p.m. (B.S.T.), and though the present conditions are such that one cannot guarantee to be able to pick up telephony at the very first attempt, some nights at any rate will bring their reward.

### Schenectady

It will be found that the short wave station at Schenectady will come in with the grid tuning condenser somewhere between 80 and 100 deg., while the station at Pittsburgh will be very much lower down the scale. Between Schenectady and Pittsburgh will be heard a very loud Morse (C.W.)

tion it will be found upon favourable nights that it is possible to receive American telephony on a loudspeaker, and though at present the reception is usually distorted and accompanied by "fading," as the winter approaches so will results improve.

### Atmospherics

During last month several attempts were made to receive American telephony, and though atmospherics were at a deafening strength on most occasions, there were few nights when the attempts were unsuccessful altogether. At



# Metres or Kilocycles?

*The use of frequency rather than wavelength is more scientific and in many cases more convenient. Some of the arguments in favour of the change are given below, with a table of kilocycle equivalents.*

**I**N the early days of wireless, when ether radiations were first investigated, the wavelength of the disturbances produced was very small (of the order of one metre or less) and could actually be measured as a length.

As the science developed, however, the wavelengths used became longer and longer, and the term wavelength became merely a method of distinguishing between different stations.

The fundamental property of any tuning circuit, however, is its *frequency*, the wavelength which may be radiated being a secondary effect. A wave-meter (so called) is in reality a frequency-meter, since it is the frequency of the circuit which is varied by the condenser or variometer employed for tuning.

heterodyne users will appreciate the saving in calculation obtained by using frequencies rather than wavelengths.

We deal in wavelengths in the H.F. amplifier and frequencies in the L.F. amplifier—a ridiculous state of affairs.

By the use of the kilocycle as a unit (1 kilocycle=1,000 cycles) it is just as easy to refer to the frequency of a station as to the wavelength.

Table:

A table is appended giving the frequencies of the principal stations heard in this country.

At present the figures in kc. are a little odd, but as the use of frequency is adopted the

Station.	Call Sign.	Wave-length.	Kilo-Cycles.	Station.	Call Sign.	Wave-length.	Kilo-Cycle.
Sheffield .. .. .	6FL	301	996	Petit Parisien .. .. .	—	345	869
Stoke-on-Trent .. .. .	6ST	306	980	Madrid .. .. .	EAJ7	392	765
Pradford .. .. .	2LS	310	967	Rome .. .. .	1RO	425	705
Liverpool .. .. .	6LV	315	952	Stockholm .. .. .	SASA	427	702
Nottingham .. .. .	5NG	325	920	Leipzig .. .. .	—	454	660
Edinburgh .. .. .	2EH	328	914	Ecole Superieure .. .. .	FPTT	458	655
Dundee .. .. .	2DE	331	906	Berlin .. .. .	—	505	594
Hull .. .. .	6KH	335	895	Prague .. .. .	PRG	555	540
Plymouth .. .. .	5PY	338	887	Lausanne .. .. .	HB2	850	353
Leeds .. .. .	2LS	346	867	Hilversum .. .. .	NSF	1050	285.5
Cardiff .. .. .	5WA	353	849	The Hague .. .. .	PCGG	1070	280
London .. .. .	2LO	365	821	Geneva .. .. .	HBI	1100	273
Manchester .. .. .	2ZY	378	793	Konigswusterhausen .. .. .	LP	1300	231
Bournemouth .. .. .	6BM	386	777	Daventry .. .. .	5XX	1600	187
Newcastle .. .. .	5NO	403	744	Radio-Paris .. .. .	SFR	1780	168
Glasgow .. .. .	5SC	422	711	Amsterdam .. .. .	PCFF	1955	153
Belfast .. .. .	2BE	439	683	Eiffel Tower .. .. .	FL	2200	136
Birmingham .. .. .	5IT	479	626			2650	113
Swansea .. .. .	5SX	482	622	East Pittsburgh .. .. .	KDKA	68	4409
Aberdeen .. .. .	2BD	495	606			309	970
Brussels .. .. .	SBR	265	1131	Schenectady .. .. .	WGY	380	789

If it is desired to know whether two stations will heterodyne one another, their frequencies must be calculated, because a frequency separation of at least 10,000 cycles may be required if the stations are not to interfere in this way; while all super-

frequencies may be changed slightly; e.g., 2LO would not work on 821 kc. but might change to 820 kc. In the future the use of kc. will be adopted by MODERN WIRELESS, the wavelengths also being given for a time.





In the studio of WGY, the well-known Schenectady station.

“WHAT do you think of American broadcasting?” “What are conditions like in New York?” “Is the interference really as bad as it is made out to be?” These and hundreds of other questions have been showered upon me every day since my return from America, where, as readers of this journal know, I have been investigating wireless conditions this summer.

As I can scarcely answer even one of these questions in a single article, I can only hope this month to give you a few impressions about New York itself, and the wireless conditions which, compared with English standards, are so strange in that city. Think of London with not *one* station such as we have at present, but a number. Think of these all broadcasting at the same time—some transmitting music, others lectures, still others

baseball scores, and here and there a hotel orchestra. Just to present to you a more detailed picture, I have drawn on another page a map showing, as near as I can, the relative positions of the leading New York broadcasting stations on the map of London. I have taken as a start station WNYC situated at the City

Hall and placed in my map on its equivalent—the Mansion House. WJZ, the Radio Corporation station on the roof of Aeolian Hall, New York, falls, by a strange chance, just about where the 2LO station is at present. The installation on the Aeolian Hall really comprises two stations, for there are two separate and distinct transmissions on different wavelengths at the same time. The two lattice steel masts, which you will see in one of the accompanying photographs, support a double aerial split in the middle by insulators



The apparatus room on the roof of WJZ-WJY, New York.



and with two down leads, The two parts of the aerial are of unequal size, one used for sending out programmes for WJZ on 454 metres (660 kc.), and the other for station WJY on 405 metres (740 kc.). I spent a very happy evening at this pair of stations, and will tell you more of them later in the article.

**A Powerful Radiator**

You may think one station at the Mansion House and a pair in Oxford Street would be quite sufficient. Continuing our scheme, we find station WEAJ (with 5 kilowatts in the aerial—no mean power to radiate in the suggested area!) placed somewhere about where Victoria Station stands. As if this were still not sufficient, about a third of the way down Park Lane we should find station WHN on the top of a variety theatre, with a wavelength of 361 metres (833 kc.). Just to make things a little brighter, a further run in a taxi-cab would bring us to a pair of stations half way down



The Switchboard for line connections for "outside broadcasts" at WJZ-WJY.

Regent Street, one practically opposite the other on the two sides of the street. These would be stations WGBS (Gimbell Bros.' Stores) and WMCA (the Hotel McAlpine broadcasting station). These work on wavelengths of 316 (950 kc.) and 341 metres (879 kc.) respectively. So as not to leave the very respectable western suburbs out of the running, we find station WFBH at the Hotel Majestic, New York, falling somewhere about where Whiteley's Stores are found in Bayswater. The wavelength of this station is 273 metres (1,100 kc.).

Don't imagine this completes the New York list. There are others. There is one station, for example, run by a Baptist church and another by a railway company, but these are not operating regularly. Those I have named can be heard almost any night, all operating at once. Just before I left New York our American contemporary *Radio News* opened the station WRNY on the top of the Hotel Roosevelt, which,

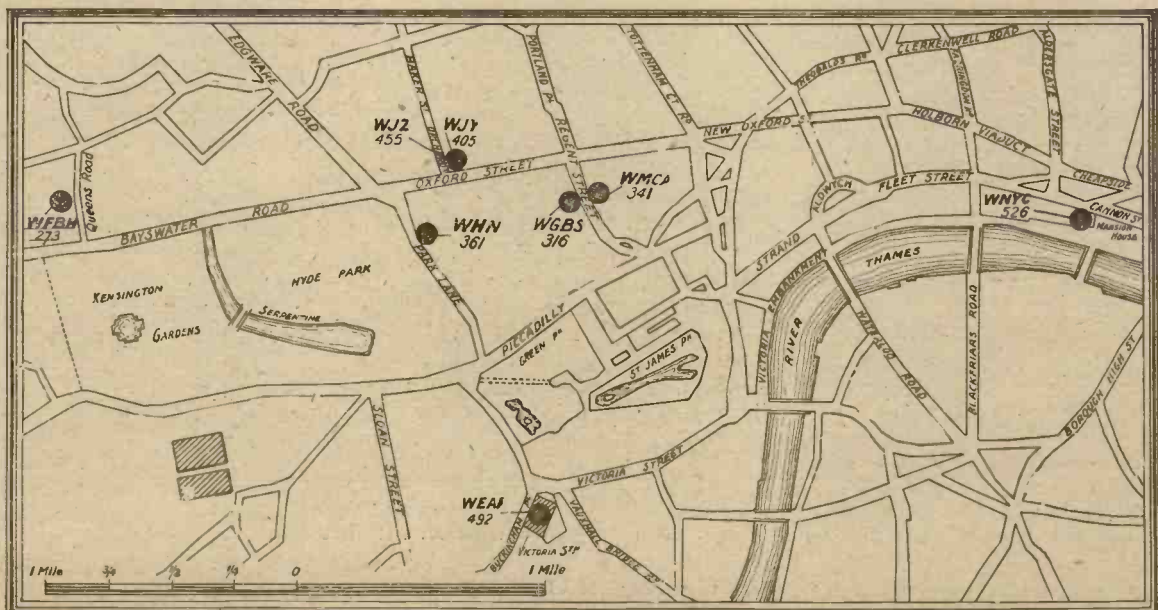

How a map of London would appear if the leading New York broadcasting stations were transferred to their relative positions in our capital.



on our converted London map would fall somewhere about Portman Square.

**Selectivity Problems**

If you were living in the heart of New York, within a stone's throw of any of these stations, you would probably experience some trouble in cutting out interference, unless, of course, you used a super-heterodyne. You might think that even with this remarkably selective instrument there would be trouble, but strangely enough it is not so. The great steel buildings have a remarkable absorbing power, and in some parts of New York screening is so great that

even the great WEAF station with its 5 kilowatts can scarcely be heard. Within a day or two of arriving I fixed up a super-heterodyne in my room on the tenth floor of the Hotel Pennsylvania. This great steel structure, the largest hotel in the world, has 2,100 rooms, each with its own private bathroom, iced drinking water on tap, six different restaurants and every convenience that American ingenuity can devise. It is situated on Seventh Avenue, between 32nd and 33rd Street. I should mention that the main thoroughfares running up and down New York are called avenues and the streets running at right angles are numbered. This rectangular arrangement of

the city makes it very convenient to find one's way about. Broadway alone of the avenues is not straight, but straggles irregularly through the city, being cut through by the various avenues at

different points. At this particular point of the city, Broadway runs almost parallel with 7th Avenue, so that a short walk up either 32nd or 33rd Street from the Pennsylvania brings you into Broadway. The "block" between 7th Avenue and Broadway, bounded by 32nd and 33rd Streets,

contains but two buildings, these joining one another. One is the Hotel Pennsylvania, already mentioned, and the other Gimbell Bros.' Stores. Gimbell's is a store similar to our own department stores in London, and has its own broadcasting station on the roof. You will thus see that next door to me I had a half-kilowatt broadcasting station. On the

opposite side of Broadway from Gimbell's stands the Hotel McAlpine, also a half-kilowatt station. At the beginning of my stay in America the actual transmissions were made from the roof of the hotel, but while I was in America a transfer was made from the top of the hotel to the towers

of the Lackawanna Railway terminal in New Jersey. The distance from the Hotel McAlpine to the Lackawanna station is but a mile or two, so that the change did not greatly relieve the congestion.

I have already mentioned where the New York stations are found, so if you think of the Pennsylvania as the Piccadilly Hotel, and these two stations WGBS and WMCA as a pair

on opposite sides of Regent Street, you will have some idea of my immediate wireless neighbours. Not wishing to disturb other occupants of the hotel with a loud-speaker, I used telephones for

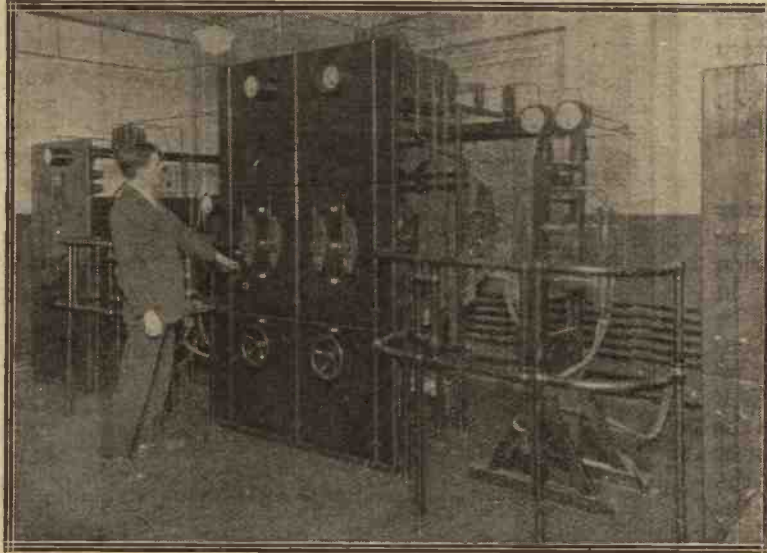

A control board at the WGY station.

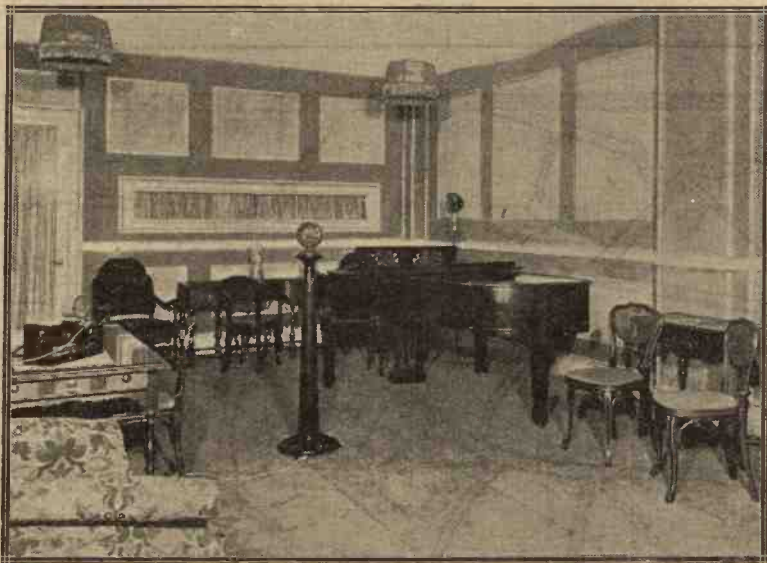

In the main studio of WJZ, New York, one of those visited by Mr. Harris when obtaining information for this article.



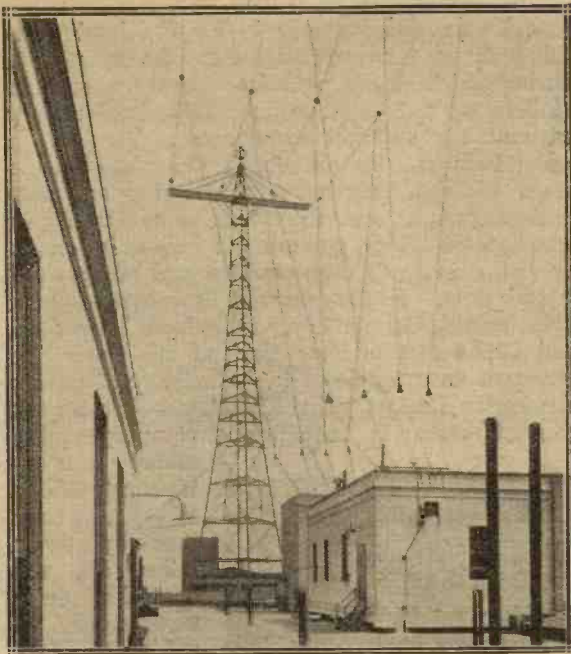

I was listening-in at the Hotel Pennsylvania I failed to get any station outside New York other than station WOR at Bamburger's Stores in New Jersey, about twenty miles away.

**Local Absorption**

This local absorption and screening is really for the New Yorkers themselves, a godsend. Strange as it may seem, there are hundreds, if not thousands, of sets other than super-heterodynes in operation in New York every night, the users having little difficulty in picking up the local station they want. American receivers are astoundingly selective, and if you are seven or eight miles away from the city, practically any of the commercial sets will give you sufficient selectivity to eliminate all the stations you don't want. From this you will see that there is not

On the roof at WJZ-WJY. The interior of the building on the right is shown on page 844.

reception, and two or three evenings after my arrival I sat down for the first time to listen-in in New York. All the stations I have mentioned were going, with the exception of that on Hotel Majestic (at Bayswater, we will say), which, owing to a dispute between the hotel owners and the people who were conducting the broadcasting service, was temporarily closed down. Gimbell's was going at full force with a soprano song, the Hotel McAlpine was running an orchestra, Broadway

The Hotel Pennsylvania, where Mr. Harris stayed in New York. The room in which some of the experiments described were conducted is situated near the arrow-point.

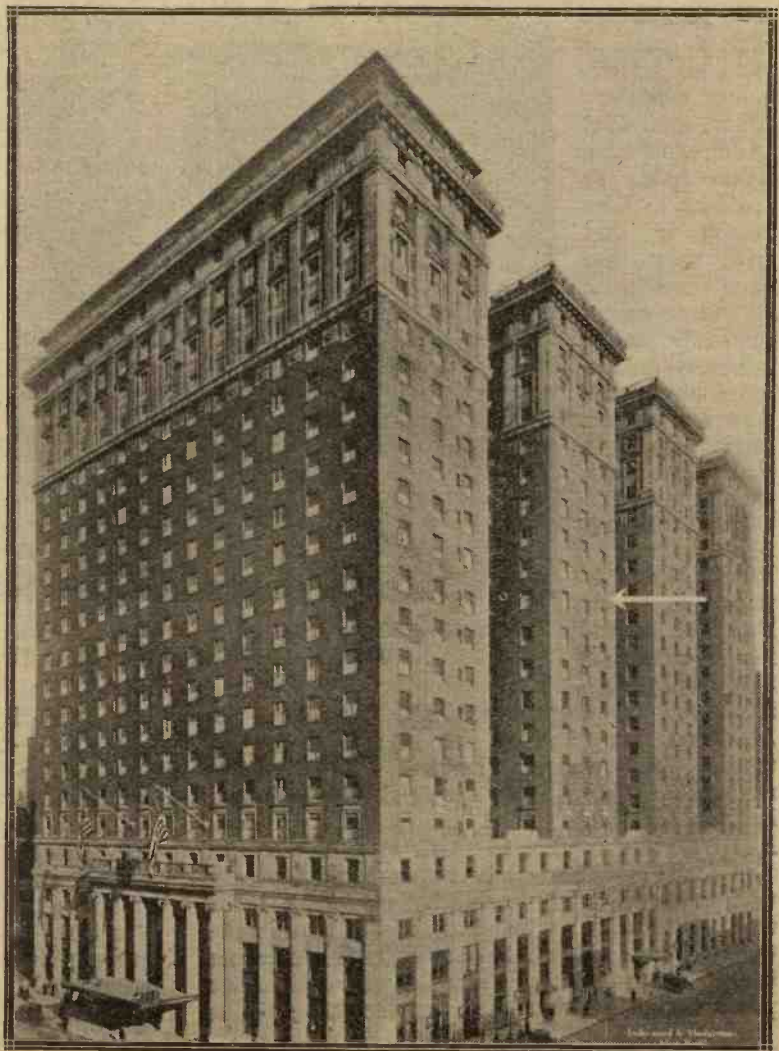

station WHN was putting a couple of comedians "on the air," while WJZ and WJY were each running their particular items. Down town, WEAF was hard at work and the Municipal station WNYC was also in full operation, yet using a super-heterodyne with a 2 ft. loop there was not the slightest difficulty in picking out one from the other as clean as a whistle. The volume from even the nearest was not great, owing to the absorption by the steel building in which I was working, and the whole of the time



a single set on the British market (other than the super-heterodyne) which would be of the slightest use in New York suburbs. Crystal sets, of course, owing to their lack of selectivity are practically dead.

**In the Suburbs**

So as to get a better idea of the receiving conditions in the average American suburban home, I listened-in on several occasions at distances of eight or nine and at forty miles. At these different places I must have used at least a dozen different receivers other than super-heterodynes, and in no case was I unable to separate the station I wanted from those not desired. Most miraculous of all, there was no howling! This may seem incredible to the British listener, but I can assure you that in the many hours of listening in America in the neighbourhood of New York, Chicago and other cities, I did not hear a single chirp, and was able to listen to distant stations with no interference whatever, other than that which came from atmospheric noises. The reason is that with very few exceptions none of the commercially made receivers radiate when used either properly or improperly, and you cannot make them radiate without altering the wiring. Would that this were so with British commercial receivers! Secondly, by

intensive campaigns against radiation the American home-builder has been educated up to the point when, if he has a regenerative receiver he does not oscillate or else he builds an instrument which has a non-radiating circuit. I am, of course, able to speak only of my own experience and it must be remembered that my visit to America was during the summer months when there is far less wireless activity than in the winter. I am told that some districts are rather bad for howling, and that in the winter time one gets a certain amount of it, but the fact remains

that I was able to listen in for five hours continuously on one occasion in a residential suburb, during which time I picked up dozens of stations at distances up to eight or nine hundred miles away without the slightest interference. The set on which I did most listening that evening had but one stage of high frequency, a detector and two note-magnifiers, and the whole of the tuning-in was done on a loud speaker, yet I was able to pick up half-a-dozen Chicago stations and others even farther west. As the crow flies (if it worried about flying so far), Chicago is 707 miles from New York, and I was east of New York at the time. To give you an example of the selectivity of the set in question, I may say that KDKA was operating on 309 metres (1000 kc.), at a distance of some 350 miles

whilst simultaneously station WAHG, some twenty-seven miles off, was operating on a wavelength of 316 metres (950 kc.). I had no difficulty in separating one from the other.

Now as to the programmes. Generally they are good and there is plenty of variety, although on the whole they are less ambitious than ours. New Yorkers are very fond of good music and the big hotels have excellent orchestras, which are frequently "put on the air." There seems to be plenty of talent available in variety, although Americans have

the same difficulty with the better talent as we have here—objection by the theatrical and concert interests. Generally the programmes follow about the same lines as our own, except there is more in the morning. Station WEAF, which is operated by the American Telegraph and Telephone Company, sends out, for example, every morning from 6.45 to 7.45 what are known as "setting up exercises." These are very popular among listeners and give them an opportunity of doing "physical jerks" under a competent instructor. At WEAF there is a continuous



Controlling the output at the "Radio News" station WRNY, on the Hotel Roosevelt, New York.



programme from 11.0 a.m. to noon, and this station starts again at 4.0 p.m., running on until about midnight. Station WJZ runs continuously from 10.0 to 11.0 and from 1.0 o'clock until about midnight. WJY seems to operate only for a short time each day, starting about 7.30 in the evening.

### A Visit to the Stations

I visited a number of the New York stations while they were actually operating. I spent, for example, a very happy evening at station WJZ, and WJY, where by the courtesy of the Radio Corporation of America, I was allowed to go just where I pleased during the whole of the evening. In fact it was nearly one o'clock when I arrived back at the Hotel Pennsylvania. The two

studios at this station are quite small compared with those at 2LO, but are tastefully fitted up with a comfortable reception room for the artistes. The announcers at this station are all University men, chosen, as are the British announcers, with a close regard to their elocution! Some of the other New York stations have very poor announcers, and one in particular is very carelessly conducted. Great care is taken at the station WJZ and WJY to ensure good reproduction, and the modulation is watched all the time by means of an oscilloscope, which shows by means of a rotating mirror a wave form corresponding with sounds

broadcast. The arrangement of the apparatus in the control room is most convenient and the whole plant has a very businesslike appearance. The transmitting panels, dynamos, etc., are

situated in a small building on the roof, the interior of which as well as the exterior are shown in one of the photographs accompanying this article.

Few of the New York stations seem to "reach out" well. WEAF, for example, although it has a power of five kilowatts in the aerial, does not seem to be so well received in England as, to take an example at random, WHAZ, a half-kilowatt station at Troy, N.Y., which I frequently hear in the winter time. This is undoubtedly due to local conditions, as the WEAF station is probably the best equipped in America, although others have more power.

I noticed that an American speaker from the London station recently referred to "thirty-eight stations in New York city broadcasting simultaneously." Actually, in my experience, on any given night, there are rarely more than eight so doing, and occasionally a ninth or tenth may break in for a few minutes.

Possibly the speaker meant "New York State"—a very large area, including stations a hundred or two miles from the city. This, of course, would include WGY, at Schenectady, WHAZ, at Troy, and many others. Salvation for the listener is found in this distance, and the main selectivity problem centres round the use of a number of stations in very close proximity to one another. Of the five hundred odd broadcasting stations licensed in the United States,

there are barely one hundred working regularly, and of the remainder a number have a power of only five or ten watts, which, of course, will not cause any appreciable interference.

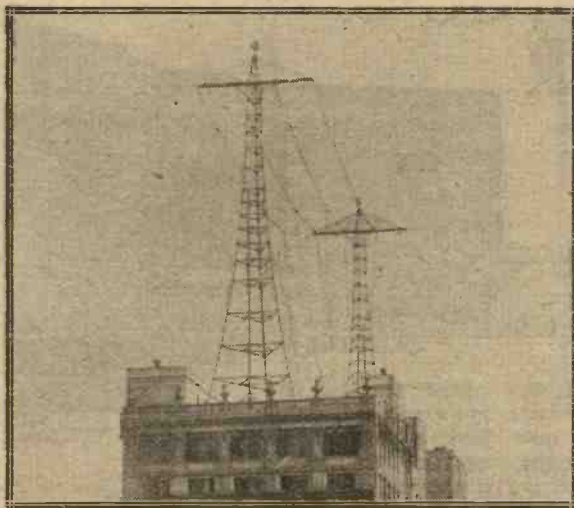

The double aerial at Station WJZ—WJY, New York.



Listening for ship distress signals at Station WJZ. Every American broadcasting station must have a certified operator continuously on watch on 600 metres, (500 kc.), so that broadcasting can be stopped immediately an SOS call is heard.



# A SIMPLE EIGHT VALVE SUPERSONIC RECEIVER

By  
W. H. FULLER



IT is interesting to look back upon the development of supersonic heterodyne receivers during the past few months and observe therefrom that considerable progress has been made, especially in the introduction of special components designed expressly for use in super-heterodyne receivers. Extensive experimenting with various circuit arrangements has also resulted in a decrease in the number of operating controls, and as a result tuning has been appreciably simplified.

frequency amplification is employed, this being found in practice to provide a convenient means of obtaining reaction (due to the inherent tendency towards self-oscillation exhibited by a straight-forward high frequency amplifying valve), convenient control of this reaction effect being obtained with the aid of the potentiometer  $R_{11}$ . The oscillator coupler has already been mentioned, two of its windings being connected in the anode and

four further terminals are supplied to allow the application of separate voltages to the oscillator valve, the intermediate frequency amplifiers, the second detector and the note magnifier.

### The Filter Circuit

The anode circuit of  $V_2$  includes the primary winding of the first long

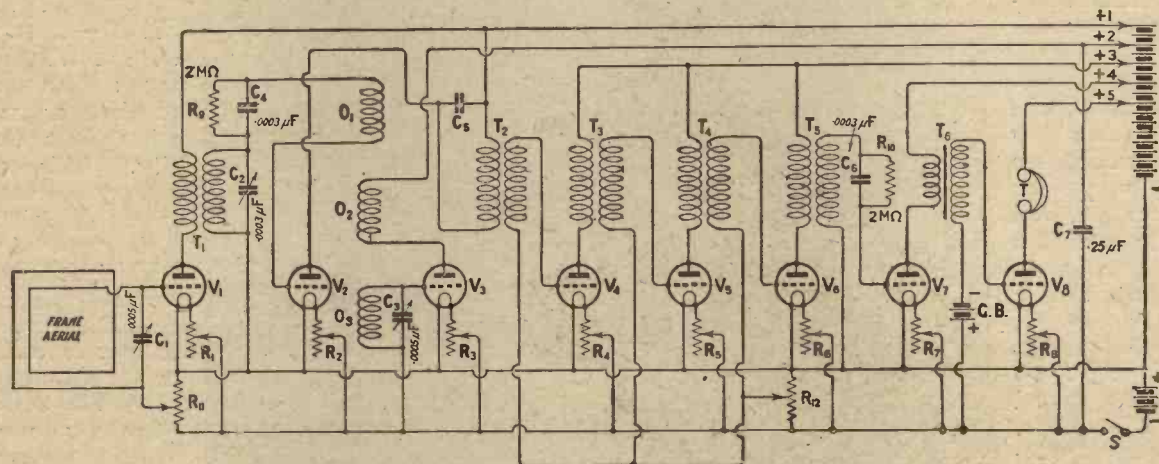

Fig. 1.—The potentiometer  $R_{11}$  serves to stabilise the first H.F. valve, while  $R_{12}$  performs the same function for the long wave amplifier.

### The Circuit

The circuit arrangement of the present receiver is shown in Fig. 1. The oscillator coupling is a unit consisting of three coils being employed as a means of obtaining oscillation of the oscillator valve and at the same time affording the necessary coupling with the grid circuit of the first detector valve.

### H.F. Amplification

A stage of ordinary high fre-

grid circuits of the oscillator valve  $V_3$  (the latter circuit being tuned by a variable condenser of  $0.0005 \mu F$  capacity) the other winding being shown as  $O_1$  in the grid circuit of the first detector valve  $V_2$ . This latter works on the leaky grid condenser principle, the grid condenser and leak,  $C_4$  and  $R_9$  respectively, having the usual values of  $0.0003 \mu F$  and two megohms.

The first two valves are given the same anode potential, while

wave transformer  $T_2$ , this being designated by some as the "filter" transformer since it does not respond to either of the two high frequency currents in the circuit but to the "beat" or "intermediate" frequency currents set up by them. The secondary winding of the transformer is connected to the first of the long wave amplifier valves  $V_4$ ,  $V_5$  and  $V_6$ . It will be seen that the lower end of each transformer secondary winding in



the long wave amplifier is connected to the slider of a potentiometer  $R_{12}$ . Experiment has proved that control of the reaction effect in this part of the receiver is necessary for obtaining the maximum output and the use of the potentiometer connected where shown generally provides adequate control.

#### L.F. Amplification

A further transformer  $T_1$  couples the last valve of the long wave amplifier and the second detector valve  $V_2$ , the leaky grid condenser method being utilised here as in the case of  $V_1$ . Only one stage of low frequency amplification is employed (transformer coupled) this being found to give ample volume for ordinary purposes. Where it is desired to obtain increased volume, however, it is not a difficult matter to add a further stage of low frequency amplification without upsetting the general working. This brings to the fore an important point which should be very carefully noted by everyone who decides to build the present receiver. The layout and wiring shown in the various diagrams and photographs have only been arrived at after considerable time spent in experimenting with various bench layouts in order to determine how

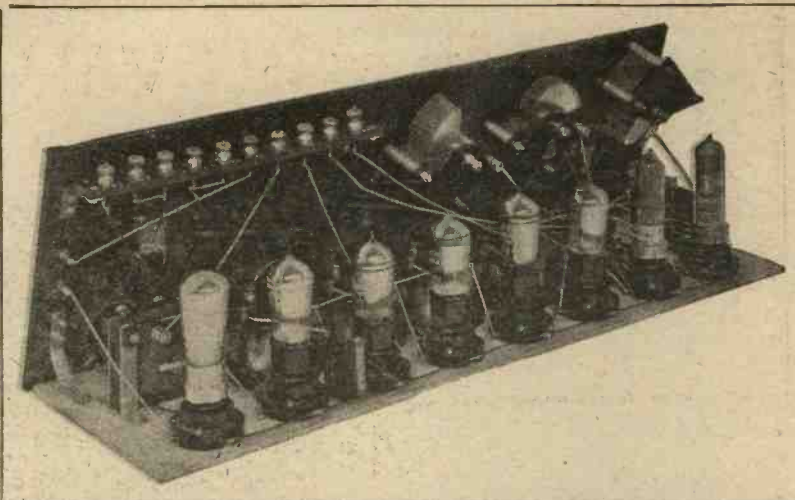

The valves, intermediate frequency transformers, oscillator coupler, etc., are mounted on the baseboard.

the various components might best be arranged so as to keep the size of the receiver within reasonable limits, at the same time having regard to the ill effects of interaction due to injudicious crowding. It is not to be imagined, of course, that results must necessarily suffer with modification of the design, but it must be emphasised that since this is always possible it is unwise to depart from a design which has

received experienced deliberation in its layout.

#### Panel Layout

A glance at the photograph showing the front of the panel will indicate clearly the simplicity of the layout. The three tuning condensers are arranged in a row near the top edge of the panel on the left, the first (extreme left) being the frame aerial tuning condenser, the second that which tunes the secondary winding of the short wave H.F. transformer, while the third varies the frequency of the oscillations generated by the oscillator valve. The terminals to which the frame aerial must be connected are seen on the left of the panel.

#### Potentiometers

The two potentiometers are placed below the variable condensers, that on the left controlling the oscillation tendency of the first valve, while the other performs a similar function for the long wave amplifying valves. Each valve is provided with a separate rheostat, these being arranged along the lower edge of the panel. An "on-off" filament switch is provided for the purpose of switching the low tension current on or off without adjustment of the rheostats—an obvious advantage, for having once found a suitable filament current for each valve the rheostats may be left alone from one night to the next. The terminals for the telephones or loudspeaker are seen on the right of the panel.

#### The Construction

As will have been gathered from the photographs, the form of con-

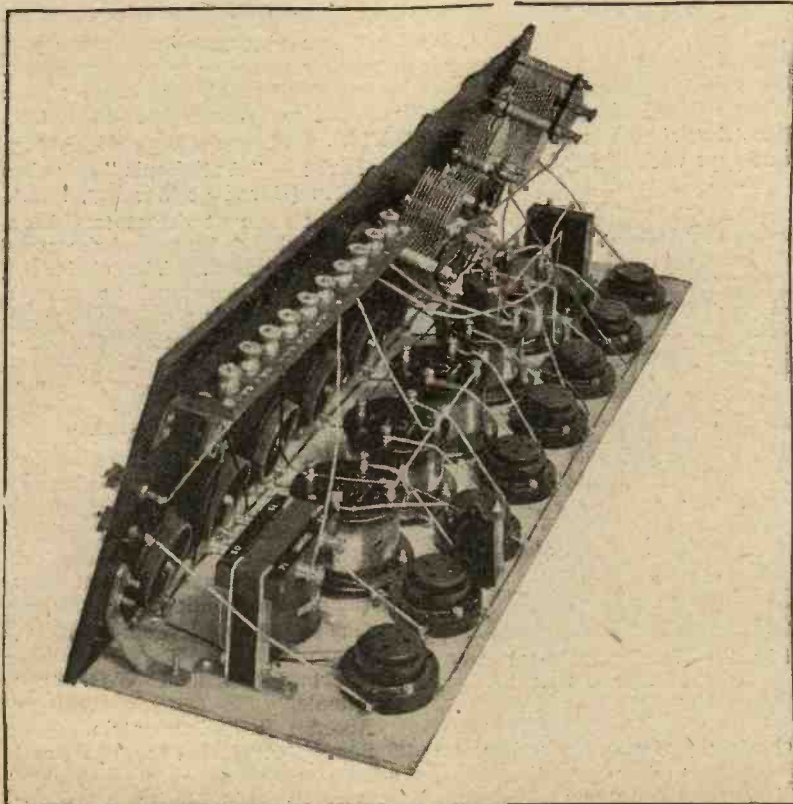

The battery terminals are mounted conveniently behind the panel.



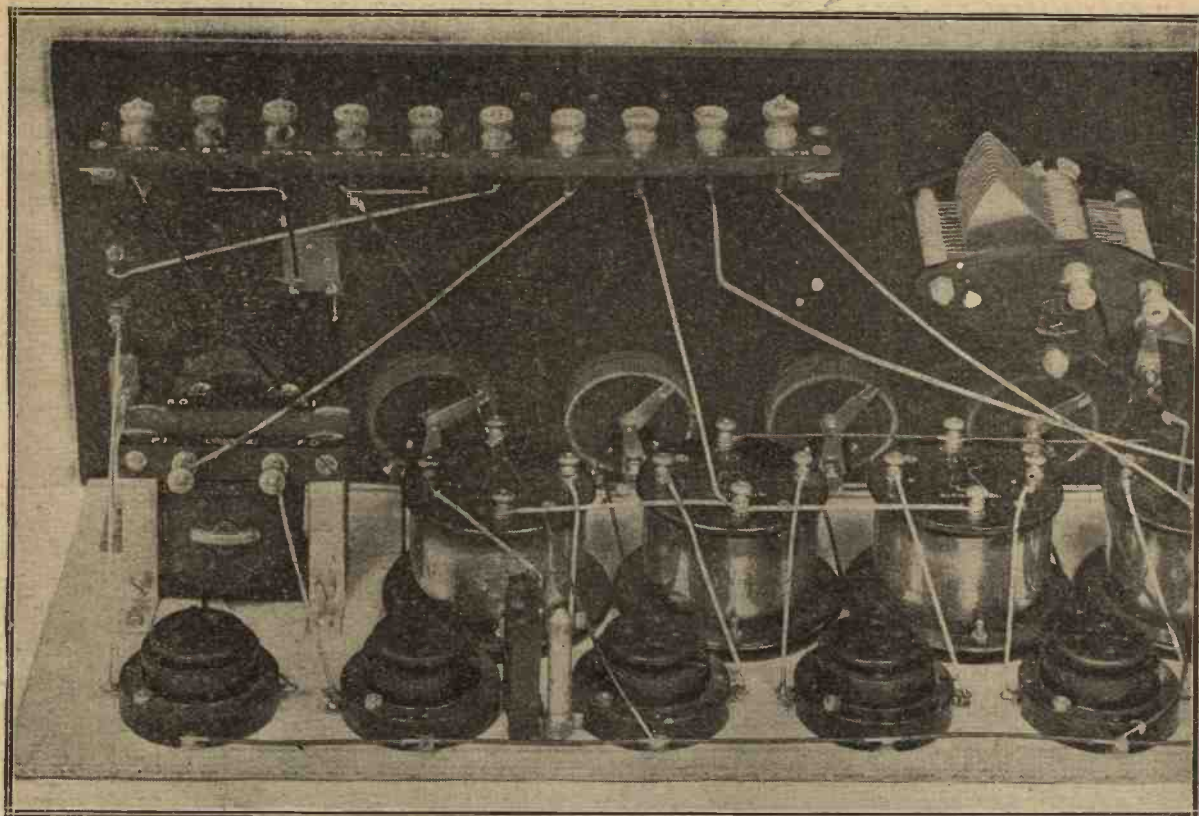

The second detector grid-leak and condenser are held in position by their connecting wires.

struction employing a baseboard for the mounting of the fixed components has been adopted. Among the latter are the long wave transformers, the low frequency transformer, valve holders, and short wave transformer holder.

The necessary terminals are mounted upon a strip of ebonite which is in turn secured to the back of the ebonite panel by means of two brass brackets. Thus it is possible to preserve a tidy appearance when using the receiver, the battery leads being passed from the interior, through the side of the cabinet to the various batteries.

**The Components**

The following list of components has been compiled for the convenience of intending constructors, and the actual makes employed are also indicated. Equal results could doubtless be obtained with other makes of components, but the less experienced amateur, at any rate, is advised to comply with the actual specifications in order to be quite certain of being able to duplicate the results obtained with the receiver as photographed.

The actual components are:—

One ebonite panel 26 in. by 8 in. by ¼ in. (Peto-Scott Co., Ltd.).

One 3-ply baseboard 26 in. by 7¼ in. by 3/16 in. (this thickness was found adequate).

One cabinet of suitable dimensions (that shown is of the sloping front type with lifting lid).

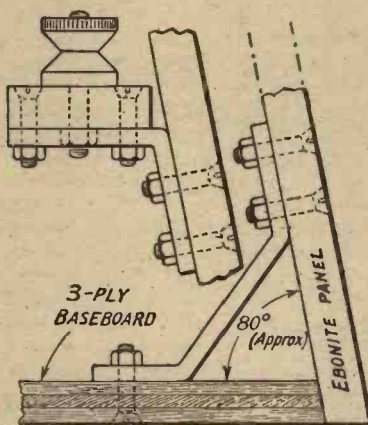

Fig. 2.—Constructional details of the brackets.

One strip of ebonite 10½ in. by 1 in. by ¼ in. (Peto-Scott Co., Ltd.).

Two .0005 μF square law condensers (Jackson Bros.).

One .0003 μF square law condenser (Jackson Bros.).

Three intermediate frequency transformers, one filter transformer and one oscillator coupler for desired waveband (Peto-Scott Co., Ltd.).

Eight "Antiphonic" valve holders (Burndept Wireless, Ltd.).

Eight filament rheostats (Lissen bright emitter wire wound rheostats have been used. The choice of rheostats is discussed at greater length in a later paragraph).

Two potentiometers (L. McMichael, Ltd.).

One .25 μF condenser (Telegraph Condenser Co., Ltd.).

One valve holder (Goswell Engineering Co., Ltd.).

Two .0003 μF fixed condensers with clips, and two 2 megohm grid leaks (Dubilier Condenser (1921) Co., Ltd.).

One low frequency transformer (Ormond Engineering Co., Ltd.).

One On-off switch (Peto-Scott Co., Ltd.).

Fourteen nickelled W.O. type terminals.

About 1 ft. of brass strip.

Supply of 6.BA. screws and nuts.

Quantity of Glazite wire for wiring purposes.

Packet of Radio Press Panel Transfers.



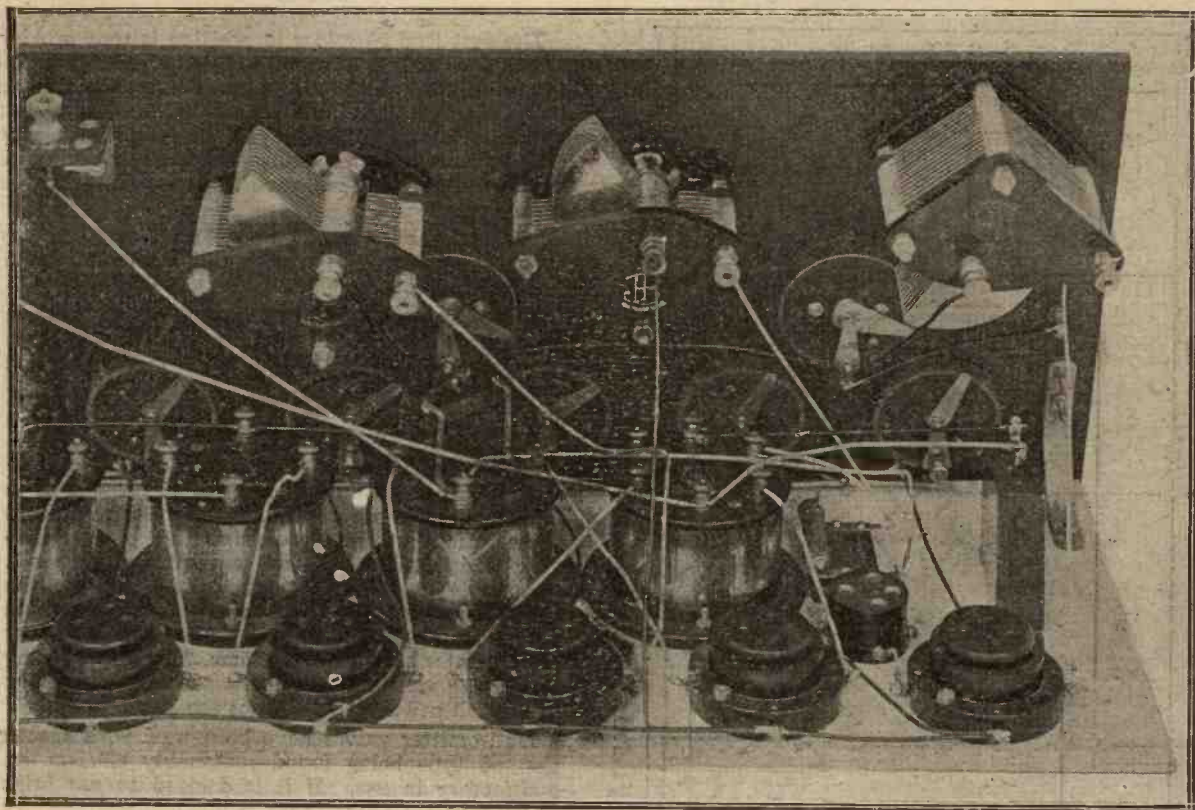

The plain type of valve socket holds the plug-in H F. transformer.

#### Drilling Operation

Having obtained the necessary components, the panel may be drilled to take the variable condensers, rheostats, etc. The correct positions for the centres of these holes are given in the diagram of Fig. 3, and the different sizes required may be determined on examination of the components themselves. The ebonite terminal strip should also be drilled at this stage, and, after mounting the terminals, may be secured to the ebonite panel in the position shown in Fig. 4, and in the manner indicated in Fig. 2. Two strips of brass are utilised, bent to the angle shown, or if it is desired to arrange the panel on a vertical plane (this may be done without ill effect) the strips should of course be bent at right angles.

#### The Switch

The "on-off" switch requires a rectangular hole in the panel to allow correct mounting, and this may be conveniently made with the aid of a fretsaw. It is possible, however, to remove a piece of ebonite of approximately the correct size by drilling a number of holes side by side around the rectangular piece it is desired to remove. After removal the jagged

edges of the hole may be filed down a little and the switch mounted. It will be found that the front metal plate of the switch hides the rough appearance of the hole.

The mounting of the remainder of the components on the panel requires no comment.

#### Mounting the Components

The next work requiring attention consists in mounting the components on the baseboard. This, while a comparatively simple task, should be undertaken with care, for if the positions shown in Fig. 3 are not copied exactly, the wiring process will be rendered more difficult. The oscillator coupler and intermediate frequency transformers are, it will be observed, secured in position with their adjacent bases just touching. It is only necessary, therefore, to find the exact position of one, when the others come naturally into their correct places.

With the transformers in position, the correct spacing of the valve holders is easily carried out, 6BA screws and nuts (the former inserted from the under side of the baseboard) being used to secure them in position. One of the grid condensers, that on the right hand side in Fig. 4, is screwed to the

baseboard while the other is to be held in position by the wiring. The remaining components to mount are the low frequency transformer, the T.C.C. condenser, and the H.F. transformer holder.

A fixed condenser ( $C_5$  in the wiring diagram) is provided by the makers with their filter transformer for matching purposes and is to be secured, as in the case of the grid condenser mentioned, by means of the wires connecting it in circuit.

#### Wiring the Panel

Before securing the panel to the baseboard it is advisable to proceed with some of the wiring on the former in order to avoid undue difficulty later. "Glazite" has been used for making the various connections, this consisting of tinned copper wire of round section, covered with insulating sleeving of various colours. In the present instance yellow sleeving indicates the grid circuits, red denotes the anode circuits, while blue and black leads have been used for the positive and negative filament connections respectively. If desired, of course, the well known bus-bar system of wiring may be adopted.



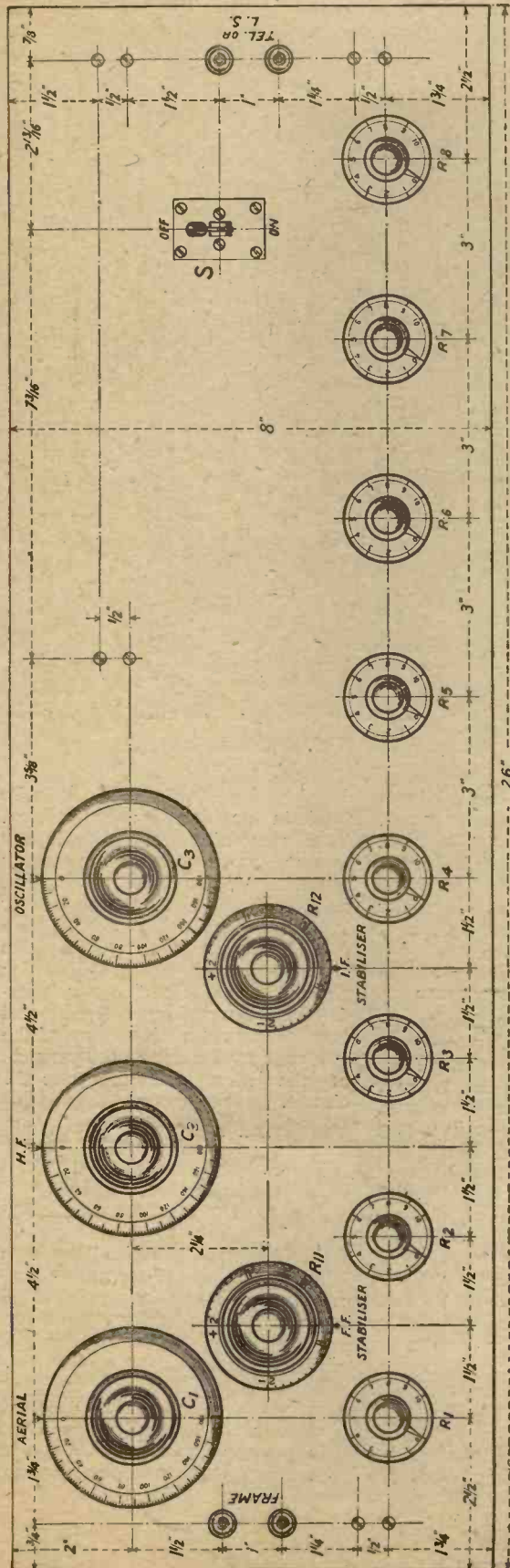

Fig. 3.—The drilling of the panel is simple for a set employing so many valves. Blue Print No. 128a. Price 1s. 6d., post free.

**L.T. Leads**

The first lead to solder in position is that making connection with a terminal of each rheostat. It is not vitally necessary to connect any other wires before fixing together the panel and baseboard, but reference to the photographs showing the wiring will indicate various other connections which, if made at this stage, will save time on coming to the main wiring.

The method of securing the panel and baseboard may be gathered from the various diagrams and photographs, Fig. 2, giving the necessary details.

There should be no difficulty whatever in following the connections given in the wiring diagram, and the photographs will prove useful in ensuring that everything is correct.

**Valves to Employ**

Before proceeding to give details of the operation of the receiver a word of advice on the matter of the type of valves to use may be helpful. Bright emitters, while suffering from the disadvantage of consuming very considerable filament current, are generally reasonably uniform in characteristic and are thus desirable where the L.T. supply is not a serious problem. The more important valves, of course, are the oscillator and H.F. amplifiers. The low frequency amplifying valve may be of the general purpose type or a small power valve such as the B4.

Dull emitter valves have been used with success, the '06 type being found reasonably efficient and satisfactory in use. If it is decided to use bright emitter valves there is no point in purchasing the special valve holders used in the present receiver. Upon the choice of valves depends also the type of rheostats required, and this should be borne in mind when obtaining the parts. The valves normally used were eight Ediswan A.R.'s.

**Preliminary Tests**

It is a good plan, before inserting the valves in their sockets, to test the filament and anode circuits for a possible fault which if present might burn out all the valves. The anode battery should be connected to its six terminals (the actual voltages selected do not matter at the moment) and a four volt flash lamp battery joined to the L.T. terminals with the switch in the "on" position. Now, with the rheostats in the "on" positions, connect, say, a flash lamp bulb across the filament contacts of each valve holder in turn. The bulb should light up in each case, and, needless to say, investigations are necessary if it burns out. If all is correct connect the accumulator in place of the flash lamp battery, turning the rheostats to their off position.

**Operating Notes**

Connect the frame aerial and telephones or loud-speaker to their appropriate terminals and place a high frequency transformer of reputable make in the socket provided. This transformer should of course be of correct size to cover the desired wavelength range. The frame aerial may be purchased or made up from dependable instructions. A suitable frame, which has been employed successfully with this receiver, was described in the June issue of MODERN WIRELESS.

The valves may now be inserted with the switch in the "on" position, and each rheostat in the "off" position. Now connect up the H.T. and grid bias batteries.



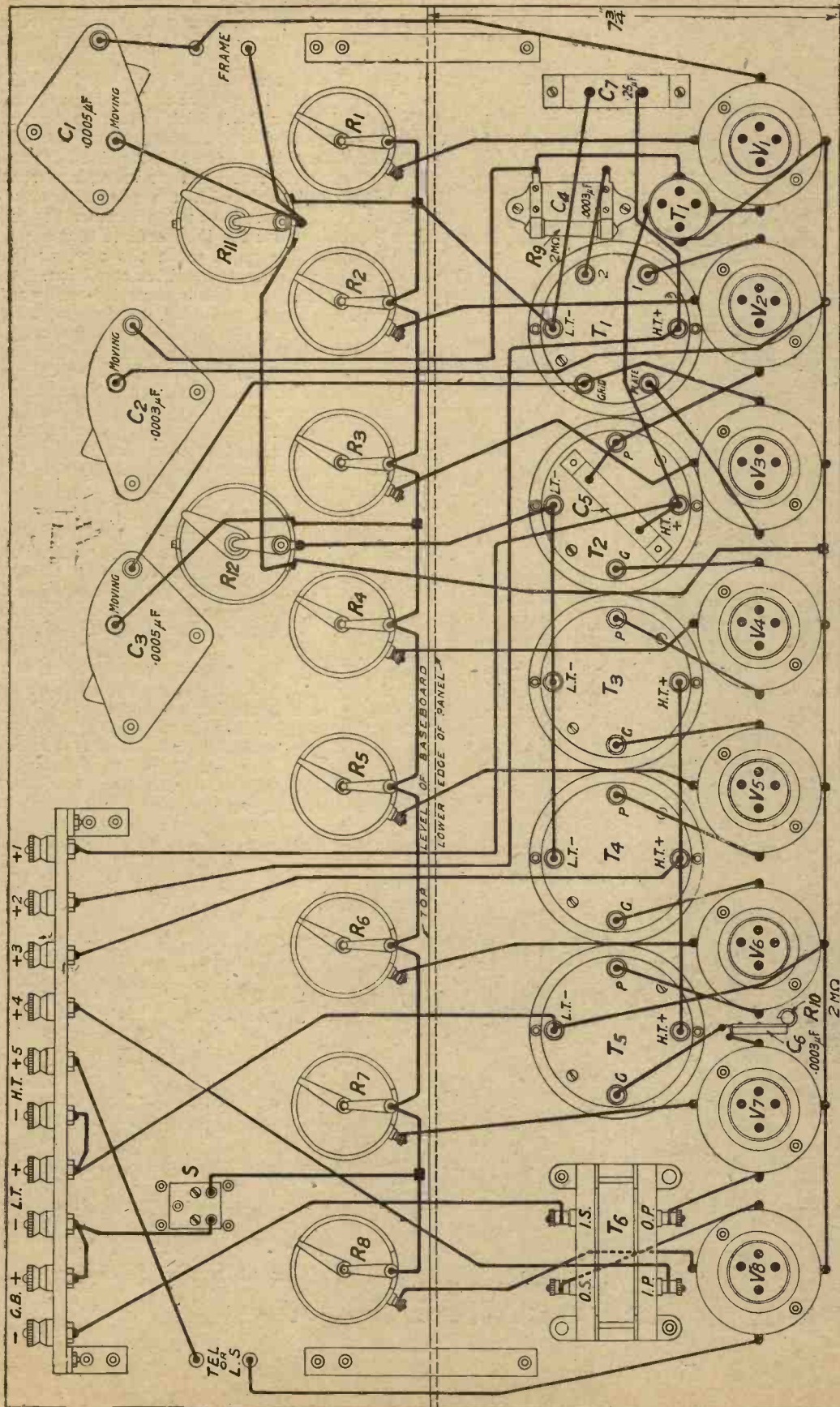
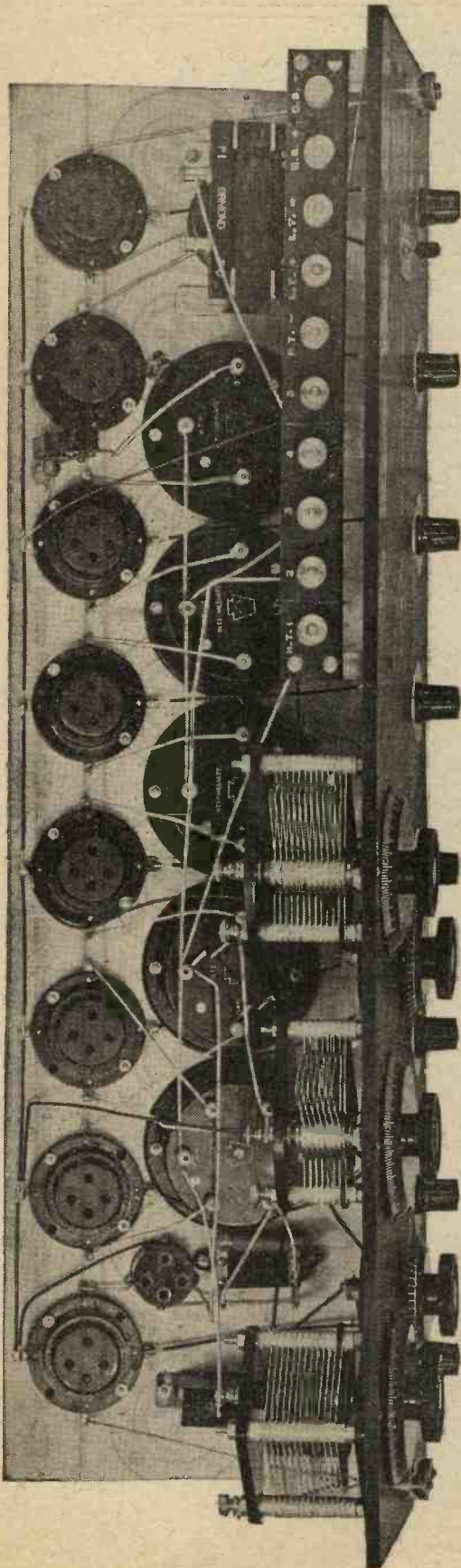

Fig. 4.—In this wiring diagram the baseboard and panel are shown in the same plane. The length of some of the wires therefore appears to be exaggerated. Blueprint No. 128b. Price 1s. 6d., post free.





The valve holders are arranged in line upon the baseboard. The L.F. transformer is secured below the terminal strip.

**Test for Oscillation**

Now light up the valves and test for oscillation. A useful guide is to turn the oscillator condenser dial, noting the number (or lack) of chirps. A large number of chirps would indicate the probability of oscillation of the long wave amplifying valves, and the potentiometer  $R_{12}$  (which should be first set to its mid-point) should be turned towards the positive end to correct this. A few chirps point to the possibility of oscillation of the first valve, and stability should be obtained with the potentiometer controlling this valve. The potentiometer  $R_{12}$  should be adjusted so that the intermediate stages are just off the oscillation point when the receiver will be found to be in its most sensitive condition.

As regards tuning, this is best carried out by adjustments of the aerial and H.F. condensers, followed by a complete rotation of the oscillator condenser dial, proceeding in this manner until signals are heard. The frame may then be rotated for improved results and the two potentiometers carefully adjusted. The rheostats should not be forgotten when delicate control is required, but it must not be supposed that a decrease of filament current necessarily results in reduced tendency toward self-oscillation. The reverse effect is frequently observed.

**Test Report**

Supersonic heterodyne receivers are distinguished for sensitivity as well as selectivity. For this reason any super-heterodyne worthy of the name will receive all the B.B.C. stations after dark on a small frame aerial, and the present instrument on test proved well up to standard. On selectivity tests, purposely conducted in daylight, when the more distant stations are always weaker, this instrument gave no trouble in separating Bournemouth from London at a distance of four miles from 2L.O, while with a little care in tuning London was eliminated from the Manchester station, these latter coming in, on a frame about 2 ft. 9 in. in diameter, at good loudspeaker strength. Oscillation control on both H.F. and intermediate frequency potentiometers was good and without overlap—meaning in effect that good control of amplification on the intermediate frequency stages and satisfactory reaction control of the H.F. stage were possible.

**A NEW F.R.S.**

\* \* \*

Readers of "Modern Wireless" will be pleased to learn that Professor Whiddington, M.A., D.Sc., who is one of the Advisory Editors of "Modern Wireless," and who is now Professor of Physics at Leeds University, has recently been made a Fellow of the Royal Society (F.R.S.).



# Anode-Input Circuits

By JOHN SCOTT-TAGGART, F.Inst.P., A.M.I.E.E.

*An account of a little known type of circuit which is chiefly interesting from an experimental point of view.*

THE words "anode-input" are used in this article to designate a type of circuit which has received very little attention from experimenters although it possesses certain merits and advantages, and, it must also be admitted, it possesses an equal number of disadvantages! I propose, however, to give some details of circuits using the anode-input method in order that readers

transmitter and a C.W. receiver, a switch being provided to change from one to the other. The design was ingenious; it was not necessary to alter the connections to the valve and it was possible to transmit and receive on a given wavelength without more than a slight alteration of the receiver adjustments. The aerial and earth were in both cases connected to the anode oscillatory circuit of the valve both when receiving and when transmitting, and reaction was obtained by a coil in the grid circuit coupled to the anode inductance. When receiving continuous waves the valve, of course, had to oscillate, and consequently the only big difference between transmission and reception was the fact that more high-tension voltage was used for transmission and the telephones were required for reception purposes. A grid-leak and condenser, of course, were also included in the grid circuit when the set was receiving continuous waves.

Fig. 1, which shows a typical simple anode-input receiver. It will be seen that the aerial is not connected to the grid circuit as is commonly done in the case of direct coupled receivers, but is actually connected to the anode; in other words, the circuit is really the wrong way round, although the telephones T are, of course, still

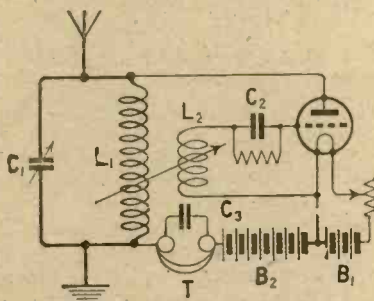

Fig. 1.—The circuit of a typical anode-input receiver.

may try out for themselves an interesting idea. None of the circuits given, in spite of their curious appearance, is any better than more ordinary circuits of rather more complicated form, but it will probably be of interest to many readers to discover whether the merits or demerits of the circuits preponderate. In any case, the idea of anode-input circuits has very distinct technical application which, while not given in this article, nevertheless is of importance in certain more complicated receiving instruments.

### Military Use

My first practical acquaintance with anode-input circuits was in France at the end of 1916, when a C.W. wireless set was designed by Captain Stanley for military use. This set operated as both a C.W.

Since the Armistice I have found that the Huth Company, a German organisation, also carried out work of a very similar character.

There is, however, some distinction between anode-input circuits used for continuous wave reception and similar circuits used for the reception of broadcasting, or other type of signals which do not require a self-oscillating valve.

It would, perhaps, be best to illustrate my point by referring to

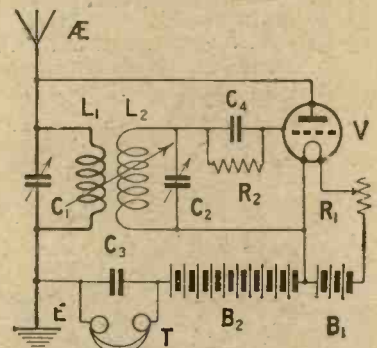

Fig. 2.—In this arrangement both  $L_1$  and  $L_2$  are tuned. This circuit gives good selectivity and a reaction effect simultaneously.

connected in the anode circuit and are shunted by the condenser  $C_3$ . The telephones and the high-tension battery  $B_2$  are not in the ideal positions, but they are left as shown for the sake of simplicity, and, as a matter of fact, their position will not seriously affect signal strength, especially if the accumulator is kept well insulated from the ground.

### C.W. Reception

If we couple the aperiodic grid coil  $L_2$  close to the aerial inductance  $L_1$ , and the coil  $L_2$  is connected the right way round, then the valve will generate continuous oscillations, the frequency of which may be controlled by the variable con-

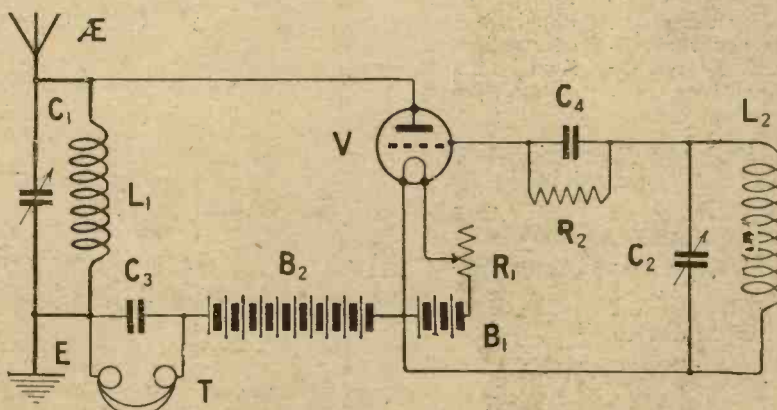

Fig. 3.—Even though  $L_1$  and  $L_2$  are widely separated, signals may still be received on account of stray capacity coupling, and other reasons given in the text.



denser  $C_1$ . This may be so adjusted as to produce beats with incoming continuous waves, and these beats, of course, will be passed on to the grid circuit and rectified by the

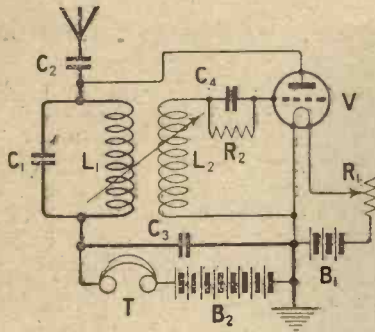

Fig. 4.—An arrangement with the telephones and H.T. battery in the aerial circuit.

valve, the required audible notes being heard in the telephones T.

**Receiving Telephony**

The position, however, when receiving telephony is different; we do not require the valve to oscillate, therefore the inductance  $L_2$  must be kept further away from  $L_1$ . In this position the incoming oscillations excite the circuit  $L_1 C_1$ , and the currents from  $L_1$  are induced into the coil  $L_2$  and so passed on to the grid circuit of a valve where they are rectified, the rectified currents appearing in the telephones T and thus producing the required signal. The actual operation of the circuit is not quite as simple as it looks. In the first place, a variation of coupling between  $L_1$  and  $L_2$  will do two things:

1. It will vary the amount of high-frequency energy transferred from the aerial circuit to the grid circuit.
2. It will alter the degree of reaction produced by the valve.

These two effects occur simultaneously and it will be readily understood that there is a considerable disadvantage in having two variable effects occurring simultaneously.

If there is a very strong reaction effect the coil  $L_2$  may have to be a considerable distance from  $L_1$ , and the amount of energy transferred from the aerial to the grid circuit will be small and there will be losses in signal strength due to this.

**A Selective Circuit**

Fig. 2 shows a modification of Fig. 1 in which the grid circuit is now tuned. In this case such an

arrangement is, of course, very selective because, although we have only two coils, we get both a reaction effect and a loose-coupling effect simultaneously, whereas to get this effect would normally require a three-coil holder. The sharpness of tuning may be readily explained by assuming, for a moment, that the connection to the anode is broken. In this case,  $L_1 C_1$  represents the ordinary aerial circuit, whereas  $L_2 C_2$  represents the grid circuit. A distinct selectivity effect is thus obtained, and if we connect up the anode again we will also get the desirable reaction effect and also connect the telephones once more in the anode circuit.

**A Disadvantage**

We have here, therefore, a very simple case of the anode-input circuit where much greater selectivity is obtained while still obtaining

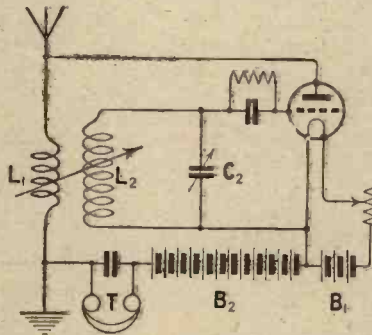

Fig. 5.—By tuning the grid circuit greater selectivity is obtained.

a reaction effect. This circuit is interesting to use but suffers from the disadvantage mentioned above, that a variation of coupling not merely alters the transfer of energy from the aerial circuit to the grid circuit, but also varies the amount of reaction, and in all these anode-input circuits a compromise is obtained, and this is easily done by using appropriate sizes of coils and not making the coils of too large a size.

**An Interesting Point**

The chief trouble with the Fig. 2 circuit, in which both anode and grid circuits are tuned, is that under normal conditions, even if  $L_1$  and  $L_2$  are widely separated, the valve will tend to oscillate, and it may be necessary to stabilise the effect by connecting a variable high resistance across the grid or anode circuit. This, however, does not appear to be a very happy method

of gaining efficiency in a wireless receiver. This disadvantage of a tendency towards self-oscillation brings out a rather interesting point—namely, that even if the inductance  $L_2$  is removed from  $L_1$ , and even if the valve does not oscillate (lowering the filament current or high-tension voltage will probably stop oscillation), signals may still be received.

**An Explanation**

Fig. 3 shows the circuit as it now appears, and the explanation, of course, is that signals are received because of stray capacity coupling and intervalve coupling, and possibly also stray inductive coupling. With this circuit, however, I am far from satisfied, although when operating the selectivity is, for obvious reasons, high.

**An Improved Arrangement**

Fig. 4 shows a rather better form of Fig. 1, because the telephones and high-tension battery are connected in the aerial circuit so as to avoid leakage in the case of the high-tension battery and also to prevent the reduction of the E.M.F.'s across the telephones T (compare my use of the transformer secondary in reflex receivers). In order that the aerial shall not be given a high-tension voltage, which may amount to 100 volts or more, a series condenser  $C_2$  is inserted as shown and this may conveniently be a constant aerial tuning condenser of 0.001  $\mu F$  capacity.

**Tuning the Grid Circuit**

The arrangement of Fig. 5 is somewhat similar to Fig. 1, except that it is now the grid circuit which

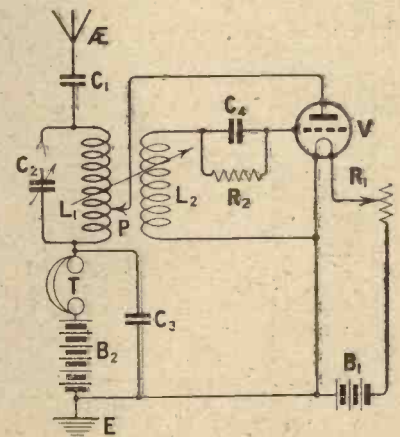

Fig. 6.—The tapping P enables a fairly tight coupling of  $L_1$  and  $L_2$  without a simultaneous big increase in the reaction effect.



is tuned instead of the anode circuit, and this is a distinctly interesting arrangement. Great selectivity is obtainable, although, as before, the high-frequency input to the grid circuit of the valve

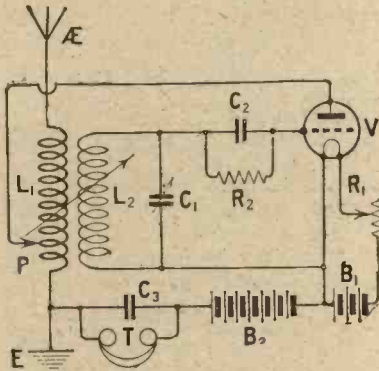

Fig. 7.—In this circuit the anode tap is taken off the aperiodic aerial coil  $L_1$ .

will vary as the coupling between  $L_1$  and  $L_2$  is varied, a variable reaction effect being simultaneously obtained.

It is possible to modify the Fig. 5 arrangement to conform to the technical advantages of having the telephones in the aerial circuit; these advantages were described in connection with Fig. 4.

**Anode Tap**

The final single-valve circuit given is shown in Fig. 6, and in this case an interesting modification is introduced by taking a tapping P off the inductance  $L_1$ . The reason for doing this is that the anode circuit of a valve which carries an appreciable anode current is shunted in the ordinary way across

the aerial inductance as in the case of Fig. 1. This introduces a considerable amount of damping into the aerial circuit. We can get rid of this effect to a certain extent by increasing the reaction, but this is not desirable. I have therefore proposed to take a tapping off only a portion of the inductance coil  $L_1$ . By this device it is possible to have a fairly tight coupling between  $L_1$  and  $L_2$  in order to enable the incoming oscillations to be communicated to the grid without a simultaneous big increase in the reaction effect. In the illustration, Fig. 6, it is therefore best to have as few turns as possible between the tapping point P and the top side of the telephone

of this tap arrangement are, therefore,

1. A tighter coupling for ordinary reception is obtainable between  $L_1$  and  $L_2$ .
2. Less damping is introduced on to the aerial circuit.

The same advantages gained by means of the anode tap are obtainable in the type of anode-input circuit illustrated in Fig. 5, and I have given an example in Fig. 7 which shows that the anode tap is now taken off the aperiodic aerial inductance  $L_1$ . Broad variations of reaction may be obtained by altering the position of the tapping point P, whereas finer adjustments may be obtained by altering the

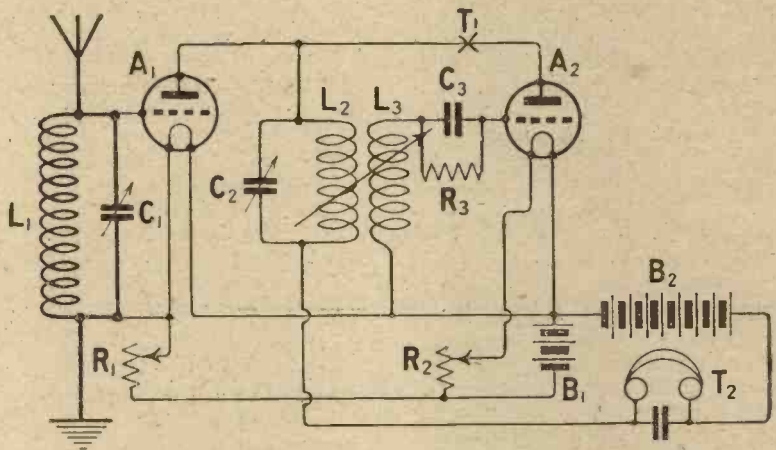

Fig. 8.—In this arrangement the first valve is acting as an H.F. amplifier, while the second valve is the detector.

receivers. In other words, sufficient inductance should appear in the anode circuit of the valve to give the required reaction effect when the coils  $L_1$  and  $L_2$  are fairly close together. The advantages

coupling between the inductances  $L_1$  and  $L_2$ .

**Two-Valve Circuits**

An unusual looking circuit is that illustrated in Fig. 8, which I have derived from the general idea pervading the preceding circuit.

This time, however, the anode-input does not apply to the first valve but to the second. We can get a whole series of new circuits by placing what amounts to a stage of high-frequency amplification in front of all the other circuits, and Fig. 8 is an example of how this may be done. It will, no doubt, appear curious when it is seen that both anodes are connected together. The first valve, however, acts as a high-frequency amplifier, and the second valve acts as a detector, the telephones being included in the anode circuit of the second valve. The fact that they are also in the anode circuit of the first valve does not make much difference, since this valve is in-

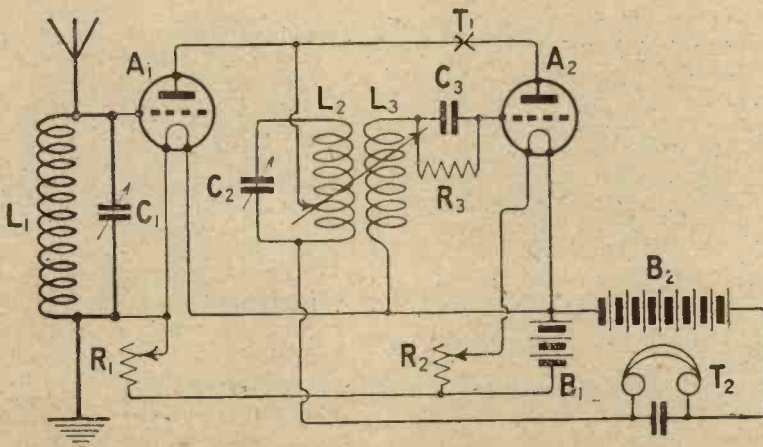

Fig. 9.—In this circuit and that of Fig. 8, the telephones, instead of being connected in the common anode circuit, may be connected at  $T_1$ .



tended to act only as a high-frequency amplifier.

**Coupling Difficulties**

The only disadvantage of this arrangement is that the reaction effect may normally be too strong and the coupling between  $L_2$  and  $L_3$  may, of necessity, be too strong, and if this coupling is reduced too much the energy transferred from the anode circuit of the first valve to the grid circuit of the second may be reduced. It is advisable in such a case to have recourse to the anode tap idea, and in Fig. 9 I show how a tapping may be taken from the inductance  $L_2$  so that only a portion of this inductance is included in the anode circuit of the second valve. Thus in Figures 8 and 9, the telephones, instead of being connected in the common anode circuit, may be connected at the point  $T_1$ . In the case of Fig. 9 this position of the telephones, which on technical grounds is not generally desirable because of its effect on the oscillating potentials in the circuit  $L_2 C_2$ , will not make any material difference.

case of single-valve circuits, must be sufficient to produce self-oscillation at least just before the

**Coil Values**  
The actual size of the coils used is a more important factor if no

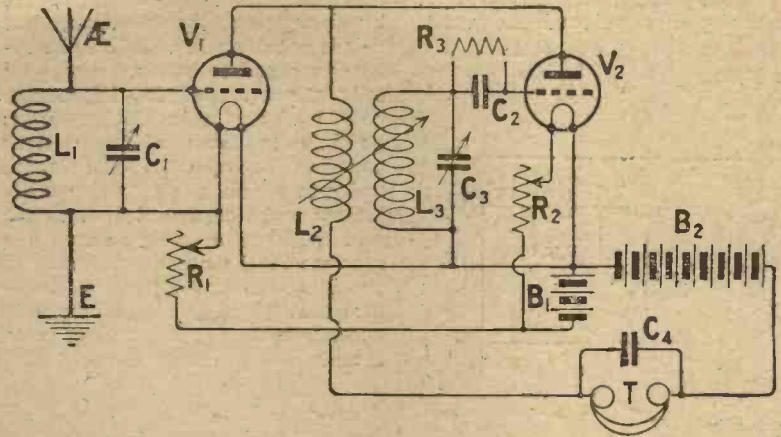

Fig. 10.—In this arrangement the anode coil is aperiodic, the grid coil  $L_3$  being tuned.

two inductance coils are brought together.

**General**

Any of these circuits, of course,

tap is employed, and it is not possible to state in this article the values, because these will vary according to the degree of reaction developed by the valve, and this in turn depends not only on the valve itself but on the high-tension voltage and filament current employed. The nature of the aerial system will also affect the tendency of the valve to oscillate and so may alter the size of coils required.

The best circuits to test out the arrangement with are probably Fig. 6, Fig. 7, and either Fig. 8 or Fig. 9 and 10.

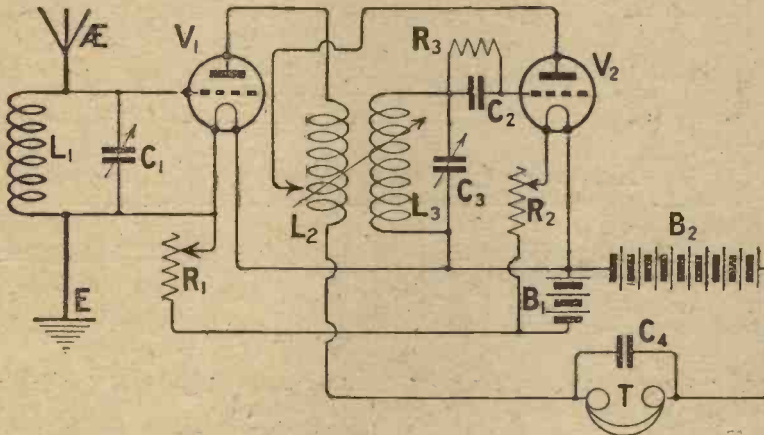

Fig. 11.—In this case the anode tap is taken from the second valve.

**Aperiodic Anode Coil**

The circuit arrangement of Fig. 9 may be modified by making the anode coil of the first valve aperiodic, tuning the grid circuit of the second valve. This is shown in Fig. 10, while Fig. 11 is a modification of the preceding circuit, the alteration consisting in taking an anode tap from the second valve. It is, of course, to be remembered that in all these circuits where anode taps are used, the amount of inductance included in the anode circuit of the second valve, in the case of two-valve circuits, or the anode circuit of the valve in the

may be further developed by adding a note magnifier, in which case the same high-tension battery and filament accumulator may be used for the extra valve. Across the grid and negative terminal of the accumulator is connected the secondary of an intervalve transformer, the primary of which is connected in place of the telephones in the circuits shown.

The anode tap idea is a valuable one generally, and there are coils on the market, such as the Lissen X type, which will enable a suitable tapping to be taken without any trouble.

**Plug-in Coils**

In general, the coils required will be similar to those used in any ordinary standard circuit; for example, the aerial coil will require to be a No. 25, 35 or 50, while the grid coil may be from a No. 35 to No. 75. The condensers across the telephones or across telephones and high-tension battery may have a value of .002 $\mu$ F.

**The Radio Press Laboratories**

Readers will learn with interest that in the October number of "The Wireless Constructor," out on September 15th, there will appear the first photographs of the new Radio Press Laboratories, at Elstree.



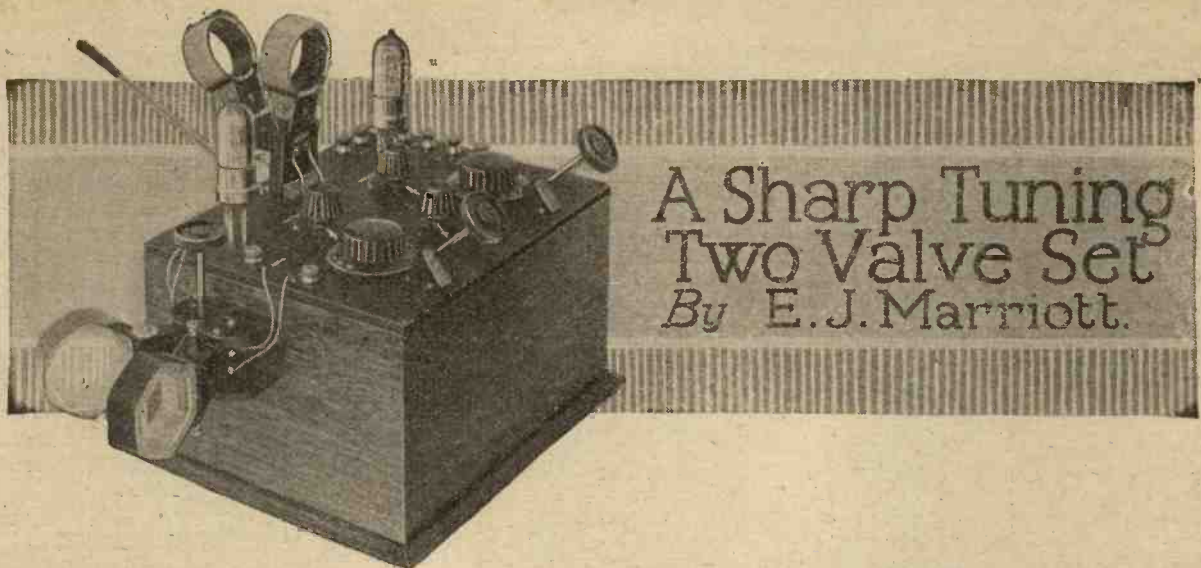

WHEN designing a two-valve receiver using one H.F. amplifier and a detector, one has a choice of several methods of coupling the two valves, the popular methods being resistance capacity, tuned transformer, tuned anode and neutrodyne. The tuned transformer method, is used very extensively in commercial as well as experimental sets with great success, in many cases the primary being the tuned winding. Generally speaking, in most H.F. transformers procurable to-day, the primary and secondary windings are wound in a manner which gives them the tightest coupling possible whilst retaining efficiency in other directions, and resulting from this, a variable condenser connected across the secondary will, to a certain extent, also tune the primary. Now, if the coupling between the primary and secondary windings can be made variable, greater selectivity is obtained than when the two windings are tightly coupled. This is borne out in practice, and in the receiver to be described, instead of one of the well-known commercial types of H.F. transformers two plug-in coils have been used, one (untuned) in the anode of the H.F. valve, and a second (tuned) in the grid circuit of the detector.

#### Aerial Coupling

A second feature in this set is that an X coil is used in the tuned grid circuit of the H.F. valve, thus allowing an auto-coupled aerial arrangement to be obtained.

The actual circuit made use of may be seen in the diagram, Fig. 1, and it will be observed that apart from the two points referred to above, it is perfectly straightforward.

#### Potentiometer Control

A potentiometer is connected across the L.T. battery, with its contact arm connected to earth, thus allowing a stabilising potential to be placed on the grid of  $V_1$ . Also, a fairly large fixed condenser ( $0.006 \mu F$ ) is used in this case, but the value is not critical) is connected between the potentiometer contact arm and L.T. negative.

Separate H.T. tapings have been provided for each valve, and a blocking condenser of 1 or  $2 \mu F$  across each tapping is generally a help towards smooth working, especially if the H.T. battery has been in use for an appreciable period. These, however, should constitute part of the H.T. equipment.

A fixed condenser of  $0.002 \mu F$  is also connected across the telephones, and in most cases for smooth reaction control, this will be found a necessity.

With regard to the valves used, the H.F. valve may be either one of the special types recommended for that work, or else may be one of the general purpose valves; the detector used is one of the usual general purpose valves.

#### Appearance

A good idea of the appearance of the instrument may be gathered from the accompanying photographs. An ordinary box type of cabinet has been used, the panel carrying all of the components except one of the coil-holders.

The coil-holder screwed to the side of the box is for carrying the aerial and reaction coils. On the panel, along the back edge, will be seen a further two coil-holder for

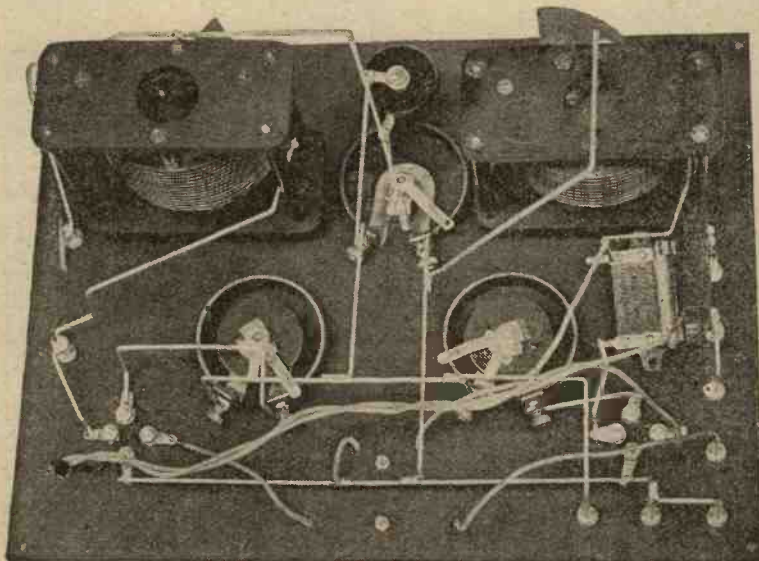

The wiring is well spaced, while the long reaction leads are twisted together.



carrying the primary and secondary coils of the H.F. transformer, and for varying the coupling between them.

It will be noticed that only two terminals are included for aerial and earth connections, but it must be remembered that an X coil is intended to be used in the aerial circuit, in which case the aerial lead is connected to one of the side terminals on the coil; the earth connection being made to the terminal so marked on the set.

If desired at any time the direct coupled aerial arrangement is easily obtained by connecting the aerial to the aerial terminal on the set, and plugging an appropriate coil in the holder.

**Components**

In order to build the set exactly as shown you will require the following components, the names of the actual makers being given for convenience in ordering. These

makes are not stipulated as essentials, but the origin of the components merely serves as a guide to the constructor, who is advised, however, in any case, to procure only good quality components.

One variable two coil-holder (Magnum).

One variable square-law condenser  $.0005\mu F$  (Success No-loss with vernier attachment), (Beard and Fitch, Ltd.).

One variable square-law condenser  $.0003\mu F$  (Success No-loss with vernier attachment), (Beard and Fitch, Ltd.).

Two 30 ohm. filament rheostats (Rothermel, Ltd.).

One potentiometer (Rothermel, Ltd.).

One fixed condenser with clips,  $.0003\mu F$  (Dubilier).

One fixed condenser  $.002\mu F$  (Dubilier).

One grid leak 2 megohms (Dubilier).

One fixed condenser  $.006\mu F$  (Dorwood).

Nine nickel terminals (Burne Jones and Co., Ltd.).

Packet of Radio Press panel transfers.

Screws, a small amount of flexible rubber-covered wire and

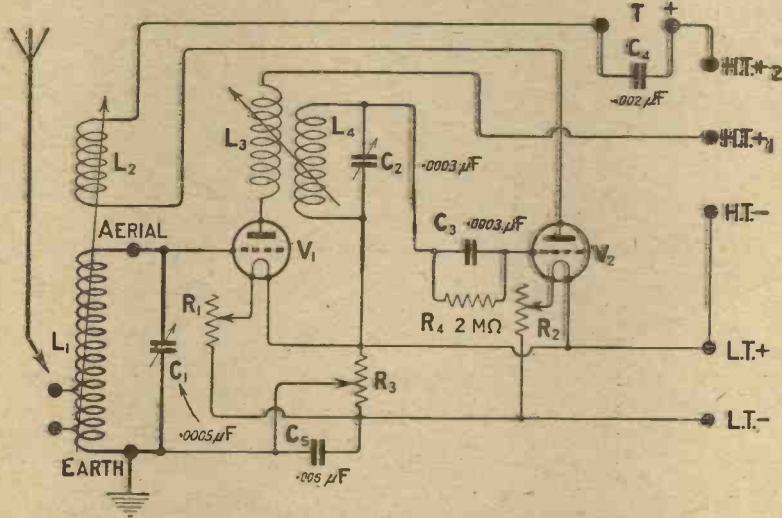
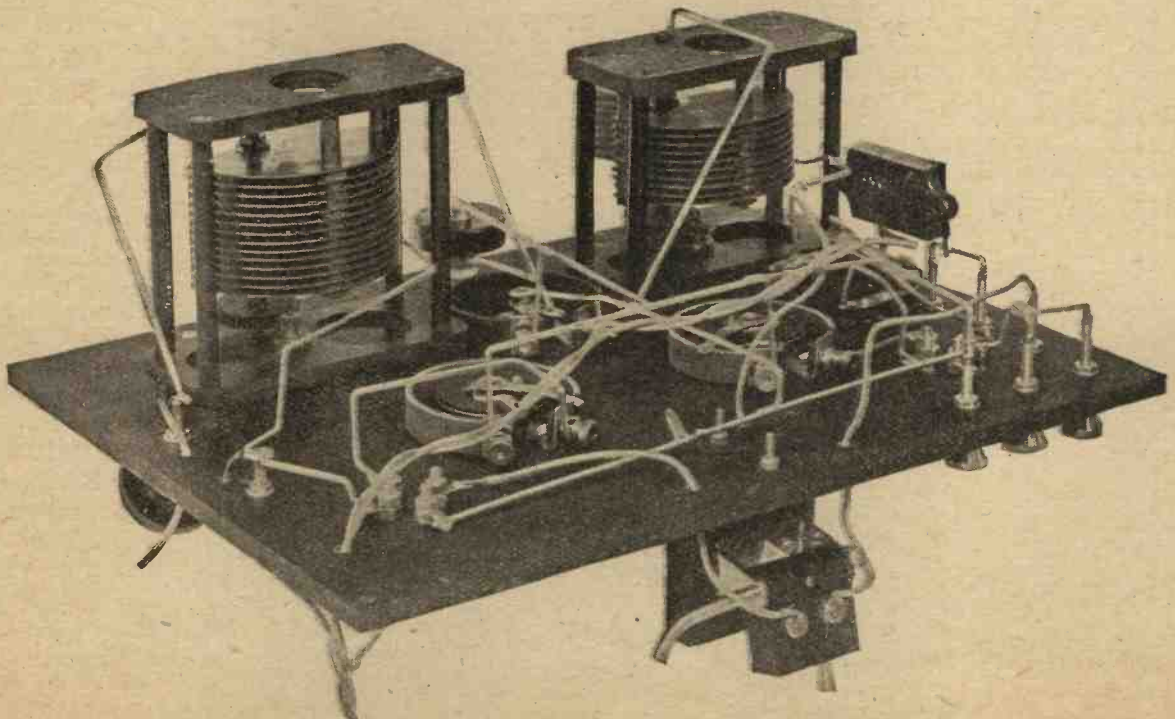

Fig. 1.—In addition to auto-coupling being used in the aerial circuit, the coils  $L_3$  and  $L_4$  are variably coupled.

One panel 12 in. by 9 in. by  $\frac{1}{4}$  in. (Paragon).

One polished oak box for same (Camco).

One variable two coil-holder (Lotus).



The flexible leads which may be seen passing through the panel on the left of the photograph are to be connected to the two-way coil-holder which is secured to the box.



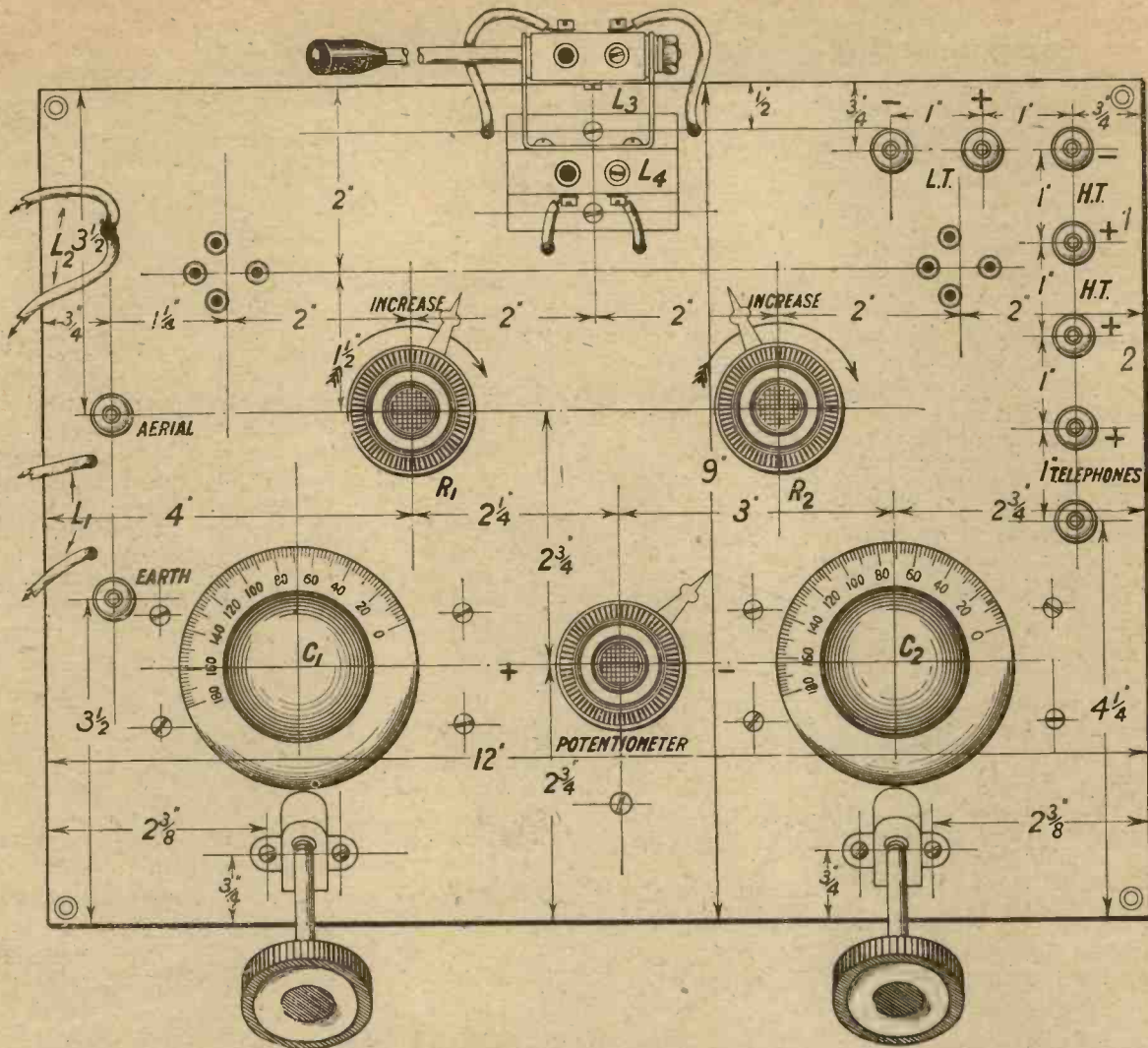

Fig. 2.—The layout of the panel is both symmetrical and simple. Blue Print No. 127a. Price 1s. 6d. post free.

a quantity of tinned square copper wire for connecting up.

**Construction**

The construction of this receiver will, I am sure, present no difficulty at all. The drilling diagram, Fig. 2, shows exactly where each hole must be drilled, and is perfectly straightforward, everything being placed symmetrically except the potentiometer. This had to be placed one quarter of an inch to the right of the panel centre line in order not to foul the condenser end plates beneath the panel. If a different make of potentiometer is to be used, assure yourself first that there is room for it.

The hole shown on the left of the H.F. valve holder is to allow the reaction leads, which should be twisted together, to pass through the panel to the variable coil-holder carrying the reaction coil. The aerial and earth connections, as well as the anode and grid

connections of the first and second valves respectively, are also brought through small holes in the panel to their respective terminal points.

When all the necessary drilling is completed, the various components may be screwed to the panel, and it will be more simple to fix the terminals and valve legs first, then the rheostats, potentiometer, and condensers, leaving the fixing of the Magnum coil-holder and the condenser vernier attachments until after the wiring is completed. Do not forget, of course, the aerial and reaction coil-holder to be fixed to the side of the cabinet. Having got so far, place the panel upside down on the box and insert a screw at two opposite corners, in the holes already drilled, in order to keep it in position. It will now be found to be in a convenient position for wiring up.

**Wiring**

The actual soldering should not present any difficulty. Reference

to the wiring diagram, Fig. 3 will show clearly where each wire is connected, and used in conjunction with the back of panel photographs will show the precise paths taken by the wiring in the actual set. The positions of the wires should be copied as nearly as possible.

All the connections should be cut and bent to shape, before any soldering is commenced. The terminal shanks and ends of the connections should now be tinned, after which the actual connecting up may be proceeded with. I have used small soldering tags for connections to the valve legs, and advise readers to do the same.

The flexible leads must be soldered to their correct connecting points, as shown in the diagram, the free ends being passed through the holes provided in the panel for that purpose, and temporarily left loose.



**Flexible Connections**

With regard to the connections from aerial and earth terminals to the coil-holder the following points must be noted. Reference to the diagram Fig. 1, which shows theoretically the auto-coupled arrangement used, will show that the earth connection must be joined to that end of the coil near which the two tappings are taken, otherwise the aerial circuit would include too many turns; therefore it is obvious that when an X coil is used there will be a right and a wrong way to connect the flex leads to the aerial coil plug. If the wiring of this receiver is faithfully copied, and a Lissen X coil used, it will be found correct to connect the aerial flex to the socket on the coil - holder and the earth flex to the plug.

**Coils**

When all connections are completed the receiver is ready for testing out.

Place two valves in the sockets (I used two general-purpose dull emitter valves for the H.F. and detector valves with a 4-volt L.T. battery), connect up the two batteries and phones and place appropriate coils in the various coil-holders. The following sizes will be found generally correct: Aerial—60 or 75 Lissen X, reaction 30 (not larger), anode  $V_1$  60, grid  $V_2$  50, 60 or 75. The aerial lead must now be attached to either one of the tappings in the X coil and the earth lead to the terminal so marked.

**Testing**

It is a good plan to test the valves for lighting with the H.T. disconnected, thus minimising the risk of losing a valve through any possible wiring error. If everything is OK connect up the H.T. and light the valves, not forgetting to adjust the potentiometer setting to its most + position, and the reaction coil to a position at right angles to the X coil. The anode and grid coils on the panel should

be tightly coupled, and on adjusting the condensers, the local station, if transmitting, should be heard at good strength. When signals have been obtained move the potentiometer slowly towards negative and it may be found that the strength increases. Great care must be taken not to allow oscillation to occur, especially during broadcast hours. A slight final adjustment in the condensers will bring in the local transmission at maximum strength.

**Interference**

When it is desired to receive

ment is reached with the set still well off oscillation point signals may be strengthened further by gradually bringing the reaction coil towards the coil.

Should this last movement cause a decrease in strength, the connections to the reaction coil must be reversed.

**Tuning Hints**

For the reception of Daventry the following coils will be found correct. Aerial 250 X or 150 ordinary; reaction 100 or 75; anode  $V_1$ —several sizes may be tried here from 150 to 300; grid  $V_2$  250.

These sizes of course will also apply to Radio-Paris. Make a note of the following points, and operating this receiver will be much more satisfactory.

Always when tuning in a station start with the minimum reaction coupling, and a positive potentiometer adjustment. When the station is heard, just bring the potentiometer towards negative gradually, and if the most negative point is reached (as it will be

with loose transformer coupling) without maximum strength being obtained, then carefully use the reaction coil. But always use the po-

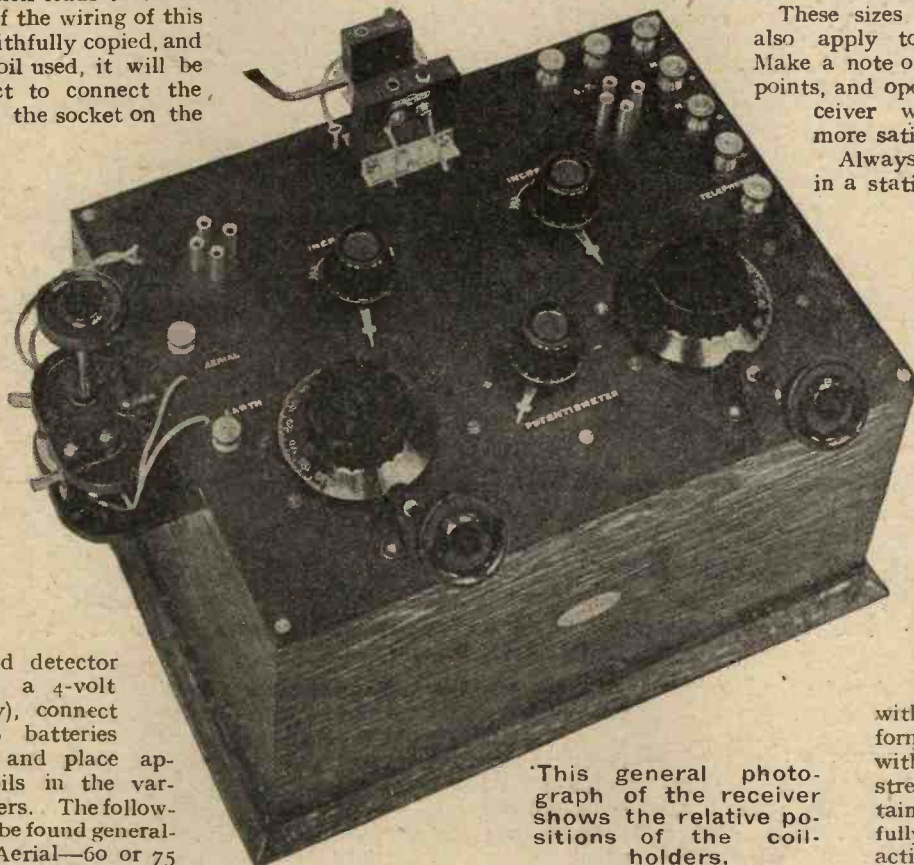

This general photograph of the receiver shows the relative positions of the coil-holders.

a different station retune on the condensers until that station is heard, most probably with bad local interference. The coupling between  $L_3$  and  $L_4$  should now be loosened, say 20 degrees, and slight retuning on  $C_2$  will bring in the station once more with the local interference greatly reduced. The coupling between  $L_3$  and  $L_4$  can be loosened still further and retuning will bring back the desired station, the strength of which will undoubtedly have suffered as the coupling was weakened. This can be speedily remedied, however, by adjusting the potentiometer still further towards negative, and if the maximum negative adjust-

tentiometer first.

Again, if you are receiving a station with  $L_3$  and  $L_4$  loosely coupled and you desire to tighten the coupling to receive a different station, first turn the potentiometer towards positive.

**Test Report**

The receiver was first tested on a moderate aerial about 5 miles west of zLO during a day-time transmission. Signals from zLO were much too loud for comfort in the phones, and, although the set is not suggested for loud speaker reception it did actually give fair loud speaking for a small



room. Birmingham was received at ample strength, and Bournemouth at good strength without any local interference. In the latter case loose transformer coupling was employed.

At night time, whilst 2LO was transmitting music, it was found possible, with loose coupling, to obtain that station at full telephone strength, and yet with 20 degrees movement on each condenser obtain absolute silence so far as 2LO was concerned.

During a short test on the night of August 6th, three German stations were heard at really loud telephone strength, Munster being particularly loud. Radio-Toulouse also came in exceedingly well, besides two other French stations which were not identified, but one of them was thought to be Petit Parisien.

On the higher waves Daventry was received at good strength, Radio-Paris being slightly weaker. The two stations could be easily separated.

## ENVELOPE No. 1.

SIR,—I have completed building the ST100 and thought that you would be pleased to hear of the splendid results.

The instrument is wired according to the diagrams in Envelope No. 1 (by John Scott-Taggart, F.Inst.P., A.M.I.E.E.); all the component parts are as specified, with the exception of the 100,000 ohm resistance.

With a 50 Igranic fixed coil, a 75 moveable coil, Mullard Ora valves and 69 volts H.T., I have succeeded in getting all the B.B.C. stations at 11 miles south of 2 LO, but cannot get Cardiff, Bournemouth and Manchester when London is working owing to interference. Newcastle, Aberdeen, Glasgow and Birmingham are very powerful, and with another valve would work a loudspeaker well.

One peculiarity of the circuit is that London is too loud on the

phones and works a loudspeaker fairly well with no aerial at all, and with a wire flex about 4 ft. long it is splendid.

Up to the present, the only Continental station received is L'Ecole Superieure, comfortably loud on phones, but up to now no others have been tried for—

Yours faithfully,  
EDWIN J. BALDWIN.  
East Croydon.

**“ WIRELESS ”**

*The One-Word  
Weekly.*

**Price - - 2d.**

No. 1,

Out on Sept. 15

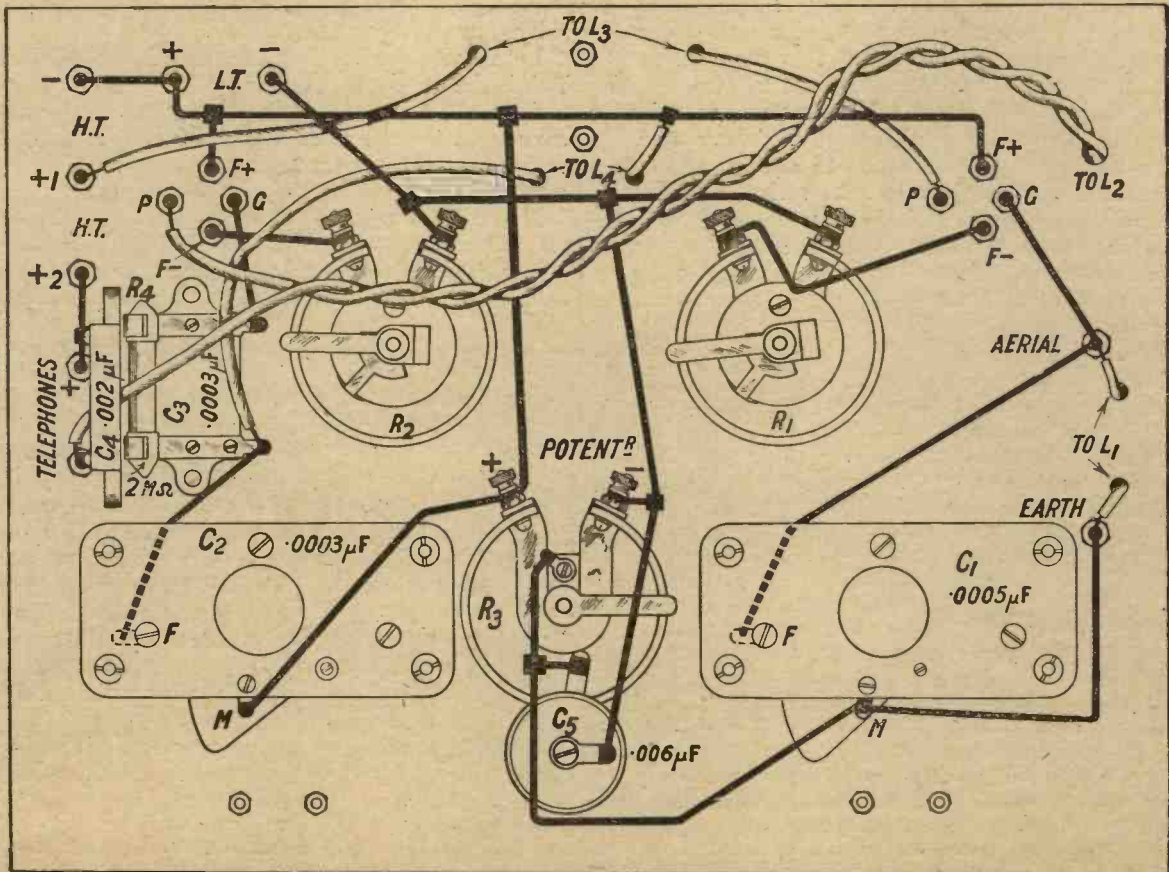

Fig. 2.—The wiring of the receiver may be easily followed from this diagram, blue prints of which may be obtained if desired. Blue Print No. 127b. Price 1s. 6d. post free.



# Efficiency in Inter-valve Circuits

By J. H. REYNER, B.Sc. (Hons.), A.C.G.I., D.I.C., Staff Editor.

*In this article, Mr. Reyner shows that the amplification obtainable with an H.F. valve depends to a very great extent on the anode circuit, and various types of anode circuit are considered from this point of view.*



IT will be as well at the beginning of this article to define exactly what is meant by "efficiency in inter-valve circuits."

There are many well-known principles in the construction of high frequency amplifiers, such as the symmetrical layout of the various components and the spacing of all the wiring as far as possible, the avoidance of capacity effects and such like, which have been referred to in previous issues, and need not be dwelt upon in this article.

## Amplification Factor

It is proposed rather to turn attention to some of the fundamental principles underlying high frequency amplification, and to discuss how the best use may be made of these principles.

Now the first essential of a high frequency amplifying valve is that it shall amplify. The extent to which it does this depends upon the make of the valve and the type of circuit with which it is used.

Various classes of valves are used, some rated as general purpose valves and others rated specifically as suitable for high frequency amplification, and all valves are given a definite amplification factor.

Some disappointment may possibly have resulted from the use of a valve having an amplification factor of, say 10, when the actual amplification obtained from the valve in its circuit is perhaps barely perceptible.

The fact is that the actual amplification of the valve is dependent upon other considerations besides the amplification factor itself. Let us consider the circuit shown in Fig. 1. The variations of grid voltage will cause similar but amplified variations of current in the anode circuit.

This anode current, however, must flow through the external circuit of the valve and in doing so produces a voltage across that circuit. (This is a fundamental property of electric currents).

The actual voltage on the anode therefore will be the difference of the H.T. voltage and the

voltage produced by the anode current flowing in the external circuit.

Now the current which will flow in the anode circuit obviously depends not only on the grid voltage but on the anode voltage itself; the less the anode voltage the less the anode current. It follows, therefore, that, in general, the anode current produced by given changes in grid voltage will be less than one would expect from the consideration of the characteristics of the valve.

## Difference between Actual and Static Characteristic

This point is so important that it may be considered in slightly greater detail.

Let us consider the characteristic shown in Fig. 2. This is the usual anode current-grid voltage characteristic of a three-electrode valve. This particular curve was taken for an anode voltage of 50, and we see that at zero grid volts the anode current was 2 milliamps.

Now the circuit on which this characteristic was taken was somewhat similar to that shown in Fig. 3, in which it will be seen that there was no external circuit in the anode of the valve, except

the milliammeter which has negligible resistance. We have seen, however, that in the case of a practical circuit there must be some form of impedance in between the anode and the high tension battery. (Impedance is a quality analogous to resistance, but includes the effects of inductance and capa-

city.) The result, therefore, is that under actual conditions the voltage on the anode would not be 50, but would be something less.

It will thus be seen that, in practice, the anode current at zero grid volts may be something less than 2 milliamps.

## Working Conditions.

Similarly, for all the other points of the characteristic shown, the actual current will not be that shown in the static characteristic. At positive grid voltages and small negative grid voltages

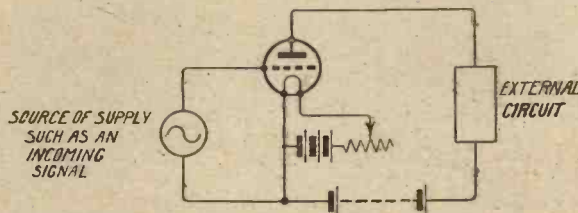

Fig. 1.—A simple amplifying valve circuit reduced to the essential points only.



the anode current will be less than that given by the static characteristic. There is a point, however, where the two currents are exactly the same, and with a larger negative grid voltage than this, the anode current, under the working condition, is greater than that given by the static characteristic.

**Effective Amplification Factor**

It will be seen, therefore, that the working characteristic of the valve is by no means the same

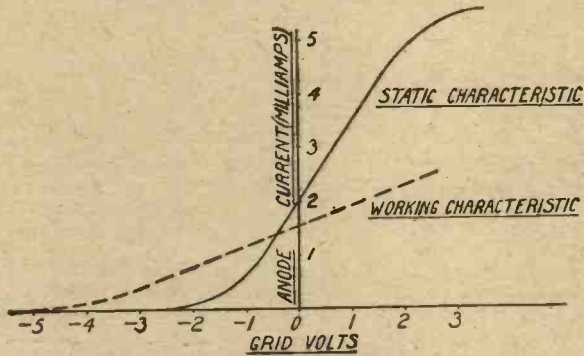

Fig. 2.—The actual characteristic of a valve, under working conditions, is quite different from the static characteristic.

as the static characteristic. The actual working characteristic is plotted in a dotted line in Fig. 2, from which it will be seen that the slope of the curve is very much less than that of the full line.

Now, it is well known that the steeper the curve the greater will be the amplification factor, other things being equal. Consequently, this reduction in the slope of the curve, due to the external circuit, means that the effective amplification factor is less than that which is obtained from the static characteristic.

To allow for this effect, we can plot the working characteristic of the valve which is being used under the actual conditions of load, but this is an unsatisfactory method, and fortunately is quite unnecessary.

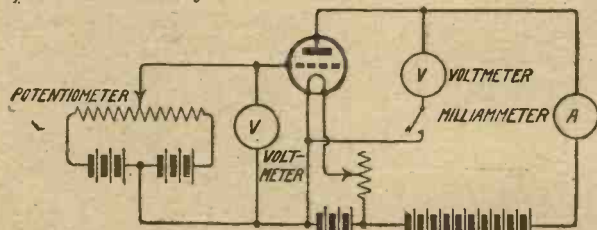

Fig. 3.—Type of circuit used for taking valve characteristics.

It is quite possible to obtain the value of the amplification factor of the valve from a knowledge of the static characteristic and the value of the impedance in the anode circuit.

**Effect of Anode Circuit**

The only two cases of any practical importance are the following :—

1. Resistance in the anode circuit.
2. An inductance in the anode circuit. In this

case the effect of the inductance at radio frequencies swamps that of any resistance in the circuit.

Now it is easy to show that in these cases the amplification factor of the valve is as follows :—

1. Resistance  $\mu = \frac{R}{R+r_i} \mu_0$

- Where  $\mu$  = actual amplification factor  
 „  $\mu_0$  = theoretical amplification factor  
 „  $R$  = external resistance in anode circuit  
 „  $r_i$  = internal resistance of the valve.

2. Inductance  $\mu = \frac{X}{\sqrt{X^2 + r_i^2}} \mu_0$

where  $\mu$ ,  $\mu_0$  and  $r_i$  are the same as before and  $X = 2 \pi \times \text{frequency} \times \text{inductance in henries}$ .

**How to Obtain Maximum Amplification**

These results show that the actual amplification is always less than the theoretical, and that in order to obtain the best possible amplification from a valve the impedance in the anode circuit should be high compared with the internal resistance of the valve. It is not proposed to discuss in this article the question of resistance amplifiers, for this type

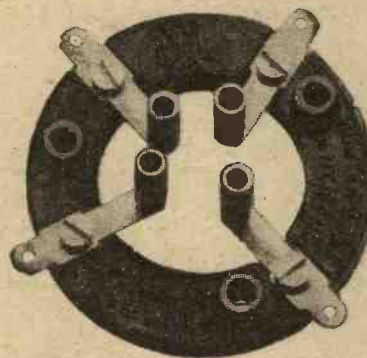

Typical form of low capacity valve holder.

of amplifier does not, normally speaking, come within the class of high frequency amplifiers on broadcast wavelengths, because unless special precautions are taken the self-capacity of the valves and the circuits forms a shunt for the high-frequency currents and the amplification

falls to a very small value. The general case, therefore, is one in which the anode circuit contains an inductance, and we have seen that in this case it is necessary to make the quantity  $X$  large as compared with the internal resistance of the valve.

**Practical Values**

Let us consider some practical values of inductances suitable for broadcast reception. The values of the inductances used for such circuits are all fairly small, and the quantity  $X$  has been worked out for a number of coils at various frequencies.

Inductance	1000 kc.	750 kc.	500 kc.
$\mu\text{H}$	300 metres.	400 metres.	600 metres.
100	628	470	314
250	1570	1175	785
500	3140	2350	1570
1000	6280	4700	3140

Now it will be seen that the largest value here is only 6280. Take the case of a Mullard D.3 H.F. valve, having an amplification factor  $\mu_0 = 17$  and



an internal resistance of 60,000 ohms. The actual amplification factor with a coil of 1000 H in the anode circuit at 1000 kc. (300 metres) will be only

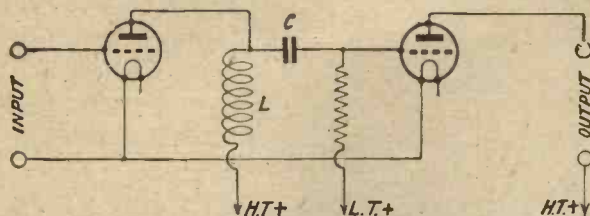

Fig. 4.—Choke-capacity coupling, illustrated in a simplified form.

1.72. If the coil in the anode circuit had an inductance of 100  $\mu$ H, the amplification factor would only be 0.172.

**Not the Fault of the Valve**

This is not in any way the fault of the valve, because to use such a valve with a small coil in the anode circuit is simply bad design.

If circumstances demanded a coil of such small dimensions in the anode circuit it would pay to use a smaller valve, having a lower impedance.

Take the case of a Mullard L.F. valve, having  $\mu_0 = 7$  and  $r_i = 15,000$ . If this valve were used with a 1000  $\mu$ H coil in the anode circuit, the actual amplification (at 1000 kc.) would be 2.71.

**High Amplification Factor not Necessarily the Best**

Thus a valve having an amplification factor of less than half the previous valve, would, under the conditions stated, give an actual amplification  $1\frac{1}{2}$  times as great, so that a valve having a high amplification factor will not necessarily give the best amplification, due to the fact that high amplification factor is of necessity accompanied by high impedance.

In order to make use of the particular properties of a valve, the anode circuit must be correctly designed.



The Mullard D.06 H.F. Valve.

**Type of Anode Circuit**

Let us consider for a moment the principal forms of coupling in high frequency amplifiers.

In order for the choke capacity system to amplify efficiently, the coil must be a large one, and should be such that X is at least equal to  $r_i$ .

This would require (at 1000 kc.) a coil of 10,000  $\mu$ H, which would give an amplification nearer the theoretical value. In the two cases just considered the results would be—

- For the H.F. valve  $\mu_0 = 17$   $\mu = 12$ .
- „ L.F. valve  $\mu_0 = 7$   $\mu = 6.8$ .

Thus, in this case, there is a distinct advantage

in using the H.F. valve, because the circuit is properly designed.

**Tuned Anode Arrangement**

A very common form of coupling is the tuned anode arrangement shown in Fig. 5. This is distinctly better, because an inductance with a condenser in parallel has a very high impedance to alternating currents, acting almost as a rejector.

The actual impedance of the circuit at the frequency to which it is tuned is given by  $\frac{L}{CR}$

- Where L = Inductance ( $\mu$ H)
- „ C = capacity ( $\mu$ F)
- „ R = resistance (ohms).

Taking a case from actual practice using a 100  $\mu$ H coil tuned with a condenser of .00025  $\mu$ F capacity and assuming  $R = 1$  ohm, the impedance is 400,000 ohms.

This will give an actual amplification nearly equal to the theoretical value

**Design of High Frequency Transformers**

The third method of coupling is that of high frequency transformers. Although this question is one requiring careful and somewhat detailed consideration, it is argued that in order to obtain the best possible amplification there should be a certain step-up ratio between the anode and grid windings (See Fig. 6).

Now, the grid windings cannot be made too high owing to the capacity of the valve from grid to filament, about which more will be said later. It is, therefore, necessary to make the anode coil as small as possible, if a step-up ratio is desired, but this we have seen will result in a very small amplification factor. If, however, the circuit is tuned, the impedance of the

tuned circuit becomes equal to  $\frac{L}{CR}$  as we have just

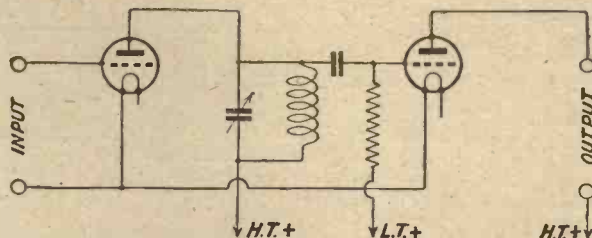

Fig 5.—Skeleton diagram of the tuned anode arrangement.

seen, and this has a value comparable with that of the internal impedance of the valve. In designing high frequency transformers, therefore, when a step up effect is attempted the value of L should be reduced as low as possible until the expression

$\frac{L}{CR}$  becomes equal to two or three

times the internal resistance of the valve. Any further reduction in the inductance would then result in an appreciable falling off in amplification.



It is for this reason that the anode circuit of high frequency transformers are tuned, rather than the grid circuit, although at first sight it would appear more desirable to tune the grid and so obtain the maximum possible voltage between the grid and filament of the valve.

It should be noted, however, that since the two windings are tightly coupled the tuning of the grid circuit has the same effect as tuning the anode circuit, so that the effective amplification

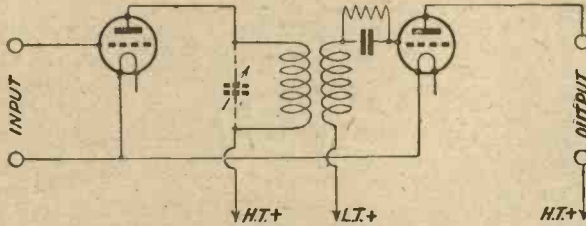

Fig. 6.—Illustrating transformer coupling.

of the valve still remains high. Tuned grid circuits may thus be used, the only disadvantage being a slight sacrifice of the step-up ratio.

#### Careful Design Necessary

It should be mentioned that there are many other factors affecting the amplification such as the effects of valve and circuit capacities. These provide alternative paths for the H.F. currents so that they do not do their work efficiently, which results in the amplification per stage being reduced much below the figures of 12 and 15 given above, and in practice an amplification of 2 per stage is difficult of achievement.

READERS of MODERN WIRELESS will have seen, no doubt, our advertisement regarding the vacancy for a Deputy Director of Research for the new Radio Press Laboratories at Elstree, this post carrying a minimum salary of £1,700 per annum. The appointment has just been filled, the successful applicant being Captain H. L. Crowther, M.Sc., who, curiously enough, has just been appointed to the same position as that held by Dr. Robinson (our Director of Research) under the Air Ministry.

Captain Crowther is at present in charge of the Wireless Research and Design Laboratories of the Royal Air Force and it is a coincidence that two successive holders of this position should have been appointed to the Elstree laboratories: Dr. Robinson is now with us, of course, and Captain Crowther will join the Company about Sept. 15th.

Captain Crowther was born in 1891, and studied at the University of Birmingham, when Sir Oliver Lodge was Principal. His special subjects were physics, mathematics, engineering and chemistry, and in 1912 he received the B.Sc., with honours, and later obtained the degree of M.Sc., for research work. Before the war he held an important

## Special Short Wave Tests from NKF

In making arrangements for special test transmissions from NKF (the station of the U.S. Naval Research Laboratory), as a result of the visit of Mr. Harris, Dr. Hoyt Taylor, the Superintendent, informs us that the station is at present working to the following schedule (in British summer time):—

“71.35 metres, work intermittently from 1 a.m. to 12 noon.

“41.7 metres, 6 p.m., with 1MY (traffic relative to MacMillan Expedition as a rule); also 3 p.m. and 8 p.m.

“The following schedules are in effect at the present time, but are subject to change:—

“We call MacMillan ships WNP and WAP on 20.8 metres for about 15 minutes, at 3.5 p.m. and 8.5 p.m. 4.30 a.m. schedule with NPM on 20.8 metres.

“9 a.m. schedule, with NRRL, on 41.7 metres.

“9CXX we generally call right after schedule with 1MY.”

These tests are being arranged through the medium of *Wireless Weekly*, in which journal details are appearing, and the co-operation is invited of all readers interested in short wave work.

## Deputy Director of Research.

Appointment of Captain H. L. Crowther, M.Sc.

scholarship for research work, while from as far back as 1911, he was a prominent amateur wireless experimenter, his transmitting and receiving station being probably one of the best known in the country. In 1914 he joined a Special Wireless Corps and at the beginning of 1915 received a commission in the Royal Naval Air Service. He was later transferred to the wireless experimental staff at Eastchurch for the development of wireless in aircraft. For the last 11 years Captain Crowther has been engaged entirely on radio research and design work for the Royal Air Force and has now risen to the highest position available to him.

Captain Crowther is an expert on valves and is a member of the Valve Committee of the Radio Research Board. He has also served on the Wireless Board. A number of his inventions were extensively used during the war and many, of course, are still in use. For these he has received awards from the Air Inventions Board.

The appointment of Captain Crowther will give a further indication of the great importance we attach to the new laboratories which will serve the Radio Press journals.



# Appointment of J. H. Reyner,

B.Sc. (Hons.), A.C.G.I., D.I.C.,

To the Staff of Radio Press, Ltd.

**I**N connection with the development of our Research Laboratories at Elstree, we have considerable pleasure in introducing to our readers Mr. J. H. Reyner, who recently joined the staff of Radio Press, Ltd.

Mr. Reyner, although comparatively young, is possessed of high qualifications, his career at the City and Guilds (Engineering) College being a record of successes.

On entering college he went straight into the second year, at the end of which time he obtained the John Samuel Scholarship for the best student of the year.

### High Qualifications

At the conclusion of the third year course he obtained the Associateship of the City and Guilds Institute (A.C.G.I.), and again headed the list of successful candidates, thereby gaining the Unwin Scholarship. He further achieved the distinction of gaining the Henrici medal for the best student in Mathematics.

He followed this up with a fourth year course in research work, under Professor G. W. O. Howe, on Radio Telegraphy and Telephony, at the conclusion of which he was awarded the Diploma of the Imperial College (D.I.C.).

During the same year he also obtained the B.Sc. Honours degree of the University of London, the special subjects being Electrical Engineering and Mathematics. Perhaps Mr. Reyner's qualifications can best be appreciated from the following extract from an official college document: "This brilliant record is nearly, if not quite, unique in the annals of the college."



Mr. J. H. Reyner,  
of the new Radio Press  
Research Laboratories.

Since leaving college in 1920 Mr. Reyner has been engaged with the Post Office Engineering Department. He has been responsible for the design of receiving equipment at the various coast and other stations controlled by the Post Office.

### Practical Experience

The work has been of a varied nature, involving the design of all classes of receiving apparatus, from small and simple sets for unskilled operation up to multi-valve point-to-point receivers, so that his experience has been essentially practical in character.

He has further been responsible for the design of complete receiving stations which have been erected under his supervision, including, in some measure, the Direction-Finding Service, which is now being

rapidly developed, so that he has been able to keep well in the forefront of developments in radio reception.

For the past three years Mr. Reyner has been Secretary of the London Students' Section of the I.E.E., in which capacity he has obtained considerable organising experience and has also come into contact with the leading men in the radio-world.

### Literary Ability

Mr. Reyner has already obtained considerable experience in the preparation of articles of interest to the radio public, and has, in fact, written two books on the subject. One of these, *Modern Radio Communication*, is fast becoming accepted as the standard low-priced textbook on wireless. The second book is a very valuable collection of data, which embraces every phase of the science, and both of these books are now published by Radio Press, Ltd.

Mathematics, as such, are of little interest to the average reader. Mr. Reyner, however, while intimately conversant with the more technical and mathematical aspects of radio, is an expert in the art of investigating problems from a theoretical and practical standpoint, and subsequently placing the results obtained in a very simple form.

Our readers may, therefore, look forward to a series of most helpful articles from Mr. Reyner's pen, many of which will be the result of research work carried out at our new laboratories, and of which a large proportion will indicate, from theoretical considerations, the most fruitful lines of experiment on any given subject.



# An entirely new wireless condenser!

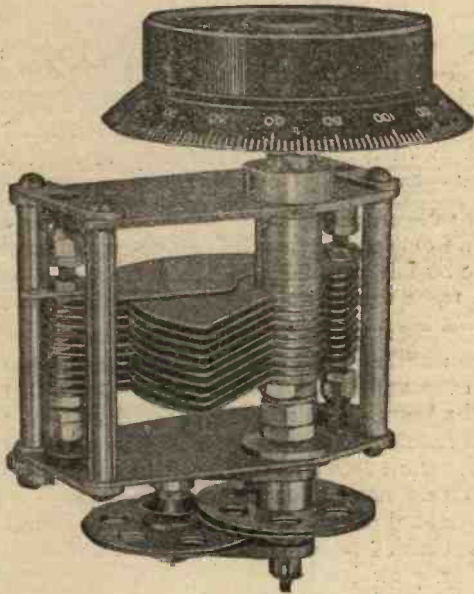

The GECOPHONE Low Loss Slow Motion variable Condenser will supersede the old-type condenser wherever valve-sets are used. It gives a new meaning to tuning, making it easy, certain and *delicately selective* to an extent hitherto unknown.

The GECOPHONE Variable Condenser is new in design, new in efficiency and performance. Of the square-law type, it provides amazingly delicate micrometer tuning with positively no backlash. Minimum capacity is lower than in any other type—dielectric losses the smallest possible; and hand capacity is eliminated. The condenser is adapted for one-hole fixing, and can be mounted on a metal panel without insulation.

*ends all tuning troubles.*

**PRICES.**

·0002 mfd	...	...	...	22/-	·00025 mfd	...	...	...	23/-
·0003 mfd	...	...	...	24/-	·0005 mfd	...	...	...	27/6
			·001 mfd	...	...	...	...	...	32/6

## GECOPHONE

### LOW LOSS      VARIABLE      SLOW MOTION CONDENSER

*Sold by all GECOPHONE Service Depots, Wireless Dealers and Stores.*

*Manufacturers—Wholesale only :*

THE GENERAL ELECTRIC CO., LTD. Head Office : Magnet House, Kingsway, London, W.C. 2.

*Branches throughout Great Britain and in all the principal markets of the world.*

*In replying to advertisers, use Order Form enclosed.*



# DULL EMITTERS

## —now is the time to face the facts

**C**LEVER advertising can sell anything once—but if the commodity does not live up to its advertised reputation then the manufacturer gets no repeat orders. His business is built upon shifting sands, the product declines in popularity and eventually disappears. On the other hand, if the article is a good one users are only too glad, not merely to keep on buying but also to testify to its merits and further its sales.

When the Cossor Valve was first introduced its novel constructional features created great interest. The sceptically-minded bought Cossor Valves deliberately to prove to their own satisfaction the fact that an arched filament almost totally surrounded by a hood-shaped Grid and Anode could make no material improvement in sensitiveness or volume.

But those who came to scoff remained to praise. Throughout the length and breadth of the land you'll find Cossor users enthusiastically acclaiming the superiority of their valves. Not merely because actual experience proves them to possess a longer life—not merely because comparative tests show them to be more sensitive to weak signals—not merely because they are entirely free from annoying microphonic noises—not merely because they yield a much purer tone. Their popularity cannot be ascribed to any one of these features but to the rare combination of them all.

And now comes the Wuncell—the first really *long life* Dull Emitter. Dull Emitters are no new discovery. They have been in existence for several years—but there is a vast difference between the laboratory specimen and the valve produced under modern manufacturing conditions in mass production. Two bugbears have always been present in the evolution of the perfect dull emitter. One the difficulty of obtaining absolute uniformity of performance, and the other, of producing a robust valve.

Not until these difficulties were definitely overcome was the Wuncell placed upon the market. The wonderful reputation enjoyed by the Cossor Bright Emitter valve could not be prejudiced by the hasty manufacture of a dull emitter merely to meet a clamorous demand.

Uniformity of performance and exceptional sturdiness are the two outstanding features of the new Wuncell. These are no idle platitudes as many thousands of Wuncell users can already testify. They are due solely to its unique filament.

Instead of whittling down the filament to secure low current consumption at the risk of fragility, that used in the Wuncell, by reason of a most elaborate process is *built up layer upon layer*. The result is a filament quite as stout as that used in any bright emitter valve. Its electron emission, however, is so vastly increased that only very little electrical energy is required to operate it. In daylight, for example, its glow is practically invisible, while at night it can only be compared to the luminous figures on a watch.

With such a filament mounted in arch formation and further secured at its centre by a third support, it is small wonder that the Wuncell was described by *Amateur Wireless* as being "almost everlasting." Valve users would do well to note that this type of filament is not obtainable in any other make of valve.

Uniformity of construction is safeguarded in the big Cossor factory through the provision of the most accurate machinery that human ingenuity can devise. Gauges accurate to one ten-thousandth part of an inch—workers long skilled in the most delicate operations—systematic tests taken during every process—the courage to discard every valve which does not reach the pre-determined standard of excellence—these are some of the reasons why the Wuncell is rapidly supplanting all bright emitter valves.

**A. C. COSSOR LTD. — Highbury Grove, London, N.5**  
**MANUFACTURERS OF COSSOR AND WUNCCELL VALVES**



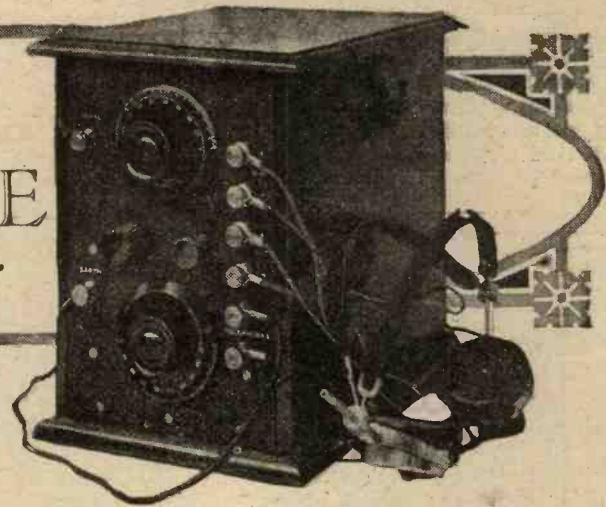

THE title of this article might well be given as "Getting the most from one valve," since the simple little set which I am about to describe is most assuredly one of the most efficient single-valve receivers for all-round work that I have had experience with. The old hand at the game will say, "That circuit again? Why I can remember it being described three years, or so, ago." That is quite true, but all MODERN WIRELESS readers are not old hands, some of them are just

beginning, others are already in possession of a crystal set and wish to go a step further and become valve users. I must therefore say to the experienced, "Stand aside, if this article does not interest you. Make way for the less experienced but enthusiastic listener who desires a reliable and well-tried circuit suitable for general work."

**The Circuit**

The circuit of this receiver is what is known as a reflex, and has been described by Mr. John Scott-Taggart, F.Inst.P., A.M.I.E.E., in its various forms from time to time in this and other Radio Press

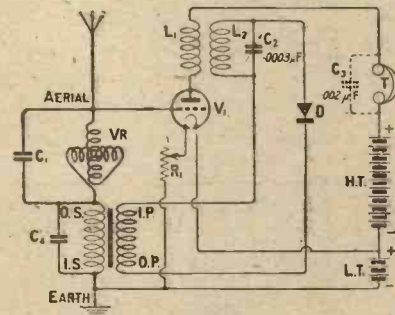
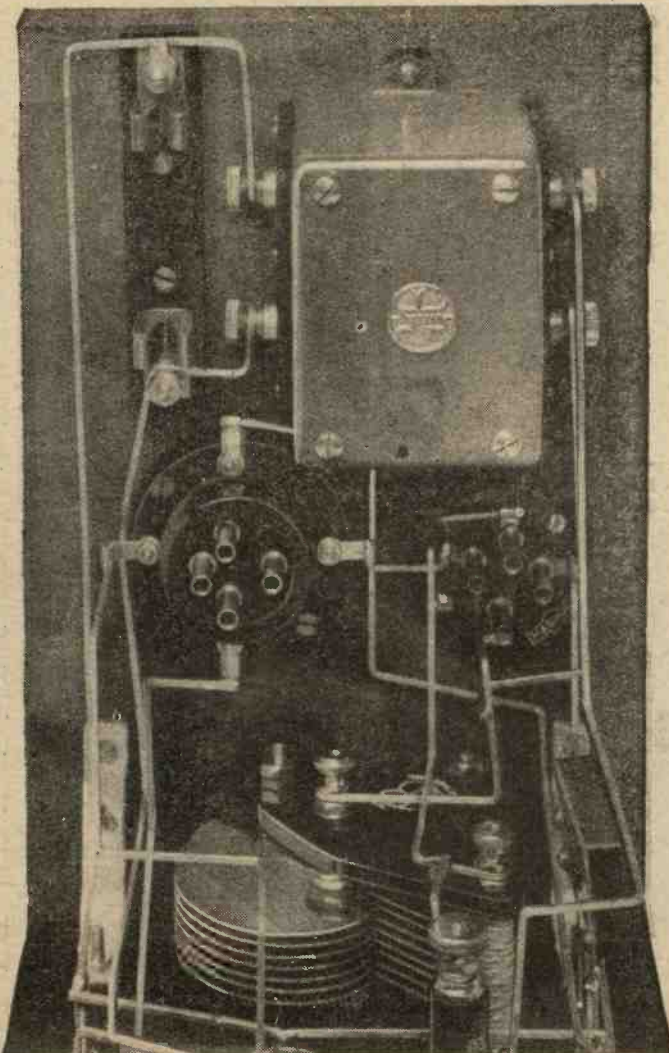

Fig. 1.—The circuit is a straightforward reflex arrangement. The condenser  $C_1$  is a clip-in type.

publications. The principle is quite simple and is briefly as follows: The incoming oscillations are amplified by the valve (marked  $V_1$  in the Fig. 1 diagram) at fundamental or high-frequency. They are then rectified by the crystal detector D, the rectified impulses then being again amplified by the valve which now acts as a low-frequency amplifier. The valve therefore performs two functions, magnifying at both incoming and audible frequency.

**Special Features**

The aerial circuit is tuned by means of the new Dubilier-Mansbridge variometer, one of the notable features of which is its extreme compactness, which will be readily appreciated from the photographs. This variometer has



The transformer, the condenser connected across the secondary winding and the valve holders, are all secured to the baseboard.



an extremely high inductance ratio and by means of a small bridging condenser will tune up to 5XX. The tuning is also quite sharp. Another feature of the set is the employment of a permanent type crystal detector, which has the advantage of being unaffected

required on the panel and, secondly, because it is a convenient article incorporating a definite "off" position.

This component was purchased in the ordinary way in London and is obtainable at a number of good retailers. It can also be

- One Cabinet panel, size 9 in. by 6 in. (Camco).
- One Variometer, Dubilier-Mansbridge type. (Dubilier Condenser (1921) Co., Ltd.).
- One .0005  $\mu$ F square law pattern variable condenser. (Jackson Bros.).
- One Crystal Detector—Permanent Mineral type, one hole fixing. (Radio Instruments, Ltd.).
- One Bradleystat filament resistance. (R. A. Rothermel, Ltd.).
- One L.F. Transformer, 1st stage. (Gambrell Bros., Ltd.).
- One Magnum Vibro valve-holder. (Burne-Jones and Co., Ltd.).
- One Magnum low-capacity valve-holder. (Burne-Jones and Co., Ltd.).
- One H.F. Transformer suitable for B.B.C. wavelengths and one suitable for the reception of Daventry, if required. (L. McMichael, Ltd.).
- One clip-in condenser base and a few clip-in condensers as sug-

**Components**

The components used in the receiver are as follows:  
 One ebonite panel, size 9 in. by 6 in. (Paragon).

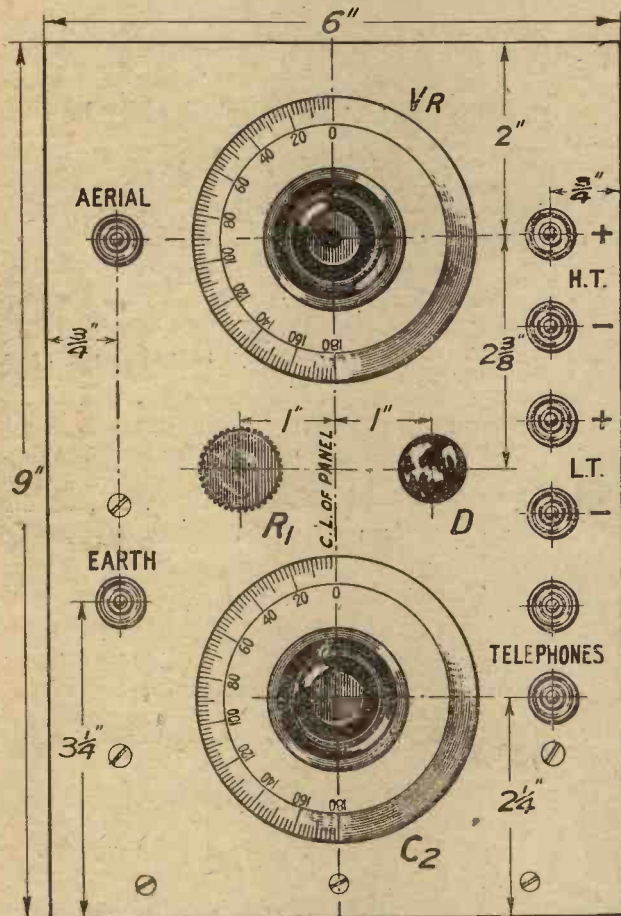
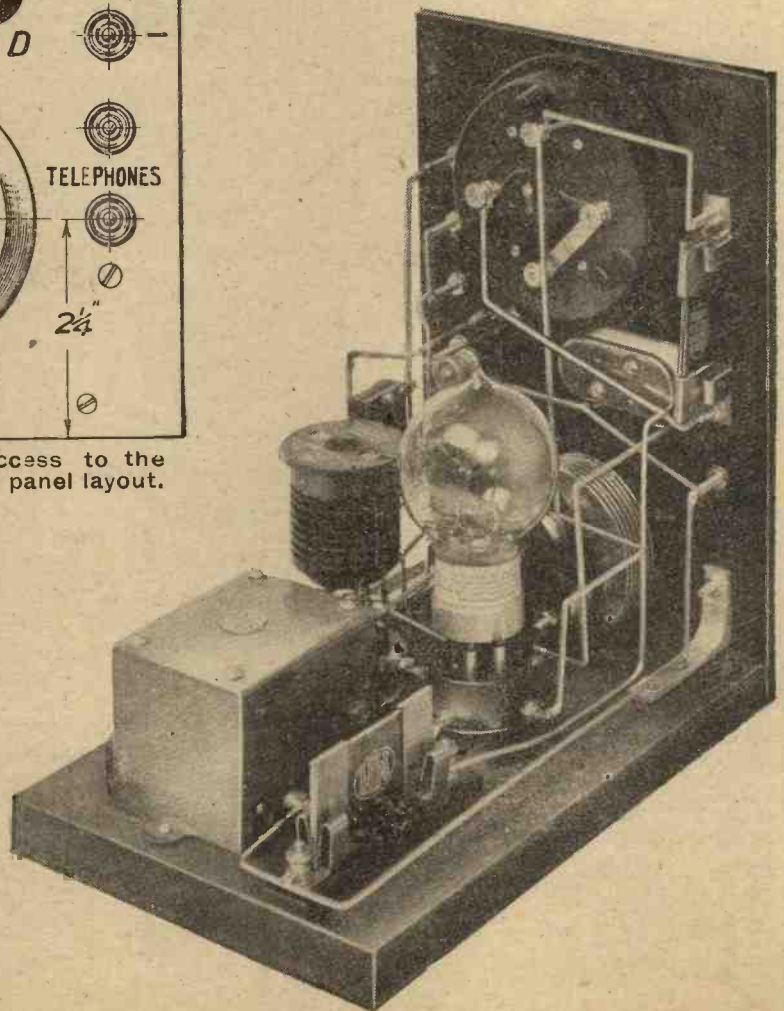

Fig. 2.—Simplicity with easy access to the controls are the features of this panel layout.

by any reasonable amount of vibration. In fact the one actually used in the set was tested independently in a bench "hook-up" and still retained its adjustment even when deliberately dropped a foot or so on to the table. A high-frequency transformer was decided upon in preference to a tuned anode owing to the fact that the crystal detector may be isolated from the steady plate current flowing in the anode circuit of the valve, and in addition, by tuning the secondary winding, a slight but advantageous increase in stability is obtained, a point which may be important in a circuit of this description. These are the chief points which characterise the receiver. It will be noticed that an American filament rheostat is used. This was chosen, firstly, on account of the small space



The receiver is both compact and well laid out for easy construction.



# LISSENIUM

## Build a Choke Amplifier the LISSEN WAY—

and get Loud Speaker reproduction  
of outstanding purity

Owing to the careful design of the coil in the *Lissen L.F. Choke* and its low self-capacity and high inductance, uniform amplification of all audible frequencies is obtained with maximum volume.

The impedance value has been chosen carefully so as to make the *Lissen L.F. Choke* suitable for use with standard L.F. or general purpose valves, and particularly with small power valves. With the *Lissen L.F. Choke* it is practically impossible for inter-stage distortion to occur.



### ECONOMY—

with the LISSEN L.F. CHOKE

The total cost of a *Lissen L.F. Choke*, *Coupling Condenser* and *Variable Grid Leak* is less than the average price of transformers. Also, when compared with resistance capacity coupling, there is a saving in H.T., the voltage with *Lissen Choke Coupling* being no greater than with transformers.

### BIG VOLUME—

with the LISSEN L.F. CHOKE

The desired volume can be built up without distortion with *Lissen L.F. Chokes* following one or two stages of transformer coupled L.F., or an amplifier can, of course, be built up throughout with *Lissen L.F. Chokes*.

The *Lissen L.F. Choke* ... .. 10/-  
For pre-eminent first stage amplification use the *Lissen T.I. Transformer*—then let the *Lissen Chokes* follow.

### LISSEN FIXED CONDENSER



The Capacity of the *Lissen Fixed Condenser* recommended for *Choke Coupled* stages is .01 mfd.

Price ... .. 4/3

*Lissen Fixed Condensers* are accurate to within 5%. They never vary—never leak—they deliver all their stored up energy.

### LISSEN VARIABLE GRID LEAK

When building a *Choke Coupled Amplifier* it is always advisable to use a variable grid leak having a wide range of variation. The *Lissen Variable Grid Leak* is continuously variable from  $\frac{1}{4}$  to 12 megohms.

*Lissen One-Hole Fixing*, of course.

*Lissen Variable Grid Leak* ... .. 2/6



Write for TEXT-BOOK of LISSEN PARTS—free to readers of this magazine.

# LISSEN LIMITED

LISSENIUM WORKS,  
20-24, Friars Lane,  
RICHMOND, SURREY

'Phone : Richmond 2285 (4 lines).

'Grams : LISSENIUM, LONDON.

BUILD WITH ALL LISSEN PARTS AND YOUR RECEIVER WILL GIVE RESULTS WHICH WOULD NEVER BE POSSIBLE WITH MIXED PARTS

In replying to advertisers, use Order Form enclosed.



# See Stand 33

ALBERT HALL

## For these New C.A.V. Productions



**TUNING COILS.**

With winding totally enclosed, these coils are wound with bare wire on a bakelite former. The illustration at side shows the method of interior construction and indicates clearly the ample air space between windings. All coils have the same external dimensions:—4 in. x 1 in.

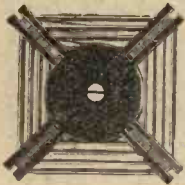

**MULTIPLE FIXED CONDENSER**

This has been specially designed to enable a selection of fixed capacities being obtained from one instrument. By connecting up the indicated capacities in parallel as required, any range can be used within the stated limits.

Cat. No.	Approx. W/L	Price
5187	250-400	6/9
5181	350-600	6/9
5182	450-900	8/-
5183	1.00-1650	9/6

Cat. No.	Price
5190 .001 to .0015 M.F.	5/-
5191 .0001 to .0015 M.F.	5/-



**GRAMPHONE ATTACHMENT**

By utilising the tone-arm of a gramophone (for the acoustic amplification of radio reception, a very effective Loud Speaker is provided. This attachment readily replaces the sound box and produces excellent results. Cat. No. 5210 Price 25/-

**FILAMENT RHEOSTAT**

With helical worked arm and interchangeable resistance unit. Very smooth and silent action. By means of a patented construction, the rotation of the contactor causes the resistance unit to revolve with it, thus ensuring smooth and silent action. The resistance unit can be instantly detached when required, to change from bright to dull emitter valves.



Cat. No.	Price
5220 7 Ohms resistance	5/-
5221 30 ditto	5/-

**NEW HORNLESS LOUD SPEAKER.**



This harmonises with the furnishing of a room and is encased in a richly polished mahogany cabinet, 15 1/2 in. long, 9 1/2 in. wide, 9 in. high. Although comparatively small it is equal in efficiency to our other types—excellent tonal quality and good volume. Cat. No. 5040 105/-



**L.F. TRANSFORMERS**

**All-Purpose Model.** Specially designed to serve as 1st and 2nd stage. In brown metal case which excludes moisture. Price 15/-  
Cat. No. 5152.  
**De Luxe Model.** Constructed with one primary winding with a secondary winding on either side; therefore minimum of self-capacity with greater amplification, which remains constant over a wide band of frequencies, in black case. Price 27/6  
Cat. No. 5150 High Ratio (first stage)  
5151 Low Ratio (second stage)

**LOUD SPEAKERS**

- Standard Ht. 22 ins. 2000 ohms Cat. No. 5015 Black Crystalline
- NEW REDUCED PRICE 90/-
- 120 ohms Cat. No. 5025 Black Crystalline
- NEW REDUCED PRICE 90/-
- 4000 ohms Cat. No. 5020 Black Crystalline
- NEW REDUCED PRICE 100/-
- JUNIOR Height 18 ins. 2000 ohms Cat. No. 5006 Black Crystalline ... 55/-
- TOM-TIT Height 13 1/2 ins. 2000 ohms Cat. No. 5001 Black Crystalline
- NEW REDUCED PRICE 27/6



**ALTERNATIVE TYPE OF HORN.**

For those who prefer a non-metallic horn, we can supply the models listed above, with imitation tortoise-shell flare as illustrated. Extra for these as follows:—

STANDARD Cat. No. 5017	15/-	JUNIOR Cat. No. 5008	12/6
TOMTIT Cat. No. 5003	2/6		

MANUFACTURERS OF MOTOR CAR ELECTRICAL EQUIPMENT



BY APPOINTMENT TO H.M. THE KING

Make your Choice and be sure of satisfaction

If unable to visit the Albert Hall, write for a copy of our complete Radio Catalogue. C.A.V. Productions are the WORLD'S BEST

**C.A.V. Vandervell & Co. Ltd.**  
WARPLE WAY, ACTON, LONDON, W.3







mentioned in the list of components. Across the secondary of the L.F. transformer try a .001  $\mu$ F condenser, and with the variometer windings joined in the series position search for your local station. You will not, perhaps, find a condenser necessary across the variometer windings, or alternatively you may find a .0001 or .0002  $\mu$ F condenser an advantage. If you have a number of these useful clip-in condensers it will be a simple matter to determine the value which gives the best results. A little adjustment of the two tuning dials should bring in the near station at good strength. Now try increasing the H.T. voltage up to say 80 or 90 volts and note whether any improvement results.

Finally experiment with various values of clip-in condensers across the L.F. transformer secondary winding, say, .0003, .0005, and .001  $\mu$ F.

**Valves**

Valves which I have found to work very well in this set are those of the "R" type such as the Marconi-Osram Co. R, the B.T.H. R the Mullard R.A. and the Ediswan R or A.R.

The Cossor P1 and P2 also give excellent results. Most of the general purpose dull emitter patterns should also be quite satisfactory. The fixed condenser connected across the telephone terminals may not in every case be necessary. On the other hand its use may improve the working of the set, and for that reason it has been included.

**Test Report**

The set was tested upon an aerial 100 ft. long, 35 ft. high (average), at a distance of 15 1/2 miles from 2LO. Several types of valves were tried, including several of the "R" type and a Cossor P1 and P2. All of these gave excellent results, 2LO giving very fair strength on the loudspeaker, while, of course, the volume in the telephones was too loud for comfort. A six-volt L.T. battery was used with 80-90 volts H.T. Using the type of valve mentioned in conjunction with a six-volt accumulator, a negative grid bias of about 2 volts is obtained owing to the fact that the filament rheostat is connected in the negative L.T. lead. The fixed condenser, C4, shunted across the L.F. transformer secondary winding had a value of .001  $\mu$ F, and no condenser was necessary across the variometer. As a further test the aerial connection was removed from the terminal marked "aerial," and 2LO was

tuned in at readable strength in the telephones. In this case a .0001  $\mu$ F fixed condenser was joined in parallel with the variometer windings. Finally, a short length of copper wire (about 15 ft.) was thrown on to the floor, one end being connected to the aerial terminal. Upon re-tuning 2LO came in at quite good strength. For the reception of 5XX using the outside aerial, it was found necessary to shunt the variometer with a .002  $\mu$ F fixed condenser, a

most excellent results on both 2LO and 5XX when using the outside aerial. This is somewhat surprising considering the high inter-electrode capacity of these valves, and good results should not be expected in every case, at any rate on the shorter waves. Immediately the aerial load was decreased, however, the set became unstable. With regard to long distance work it may be mentioned that a reflex circuit is not ideal in this respect, but one

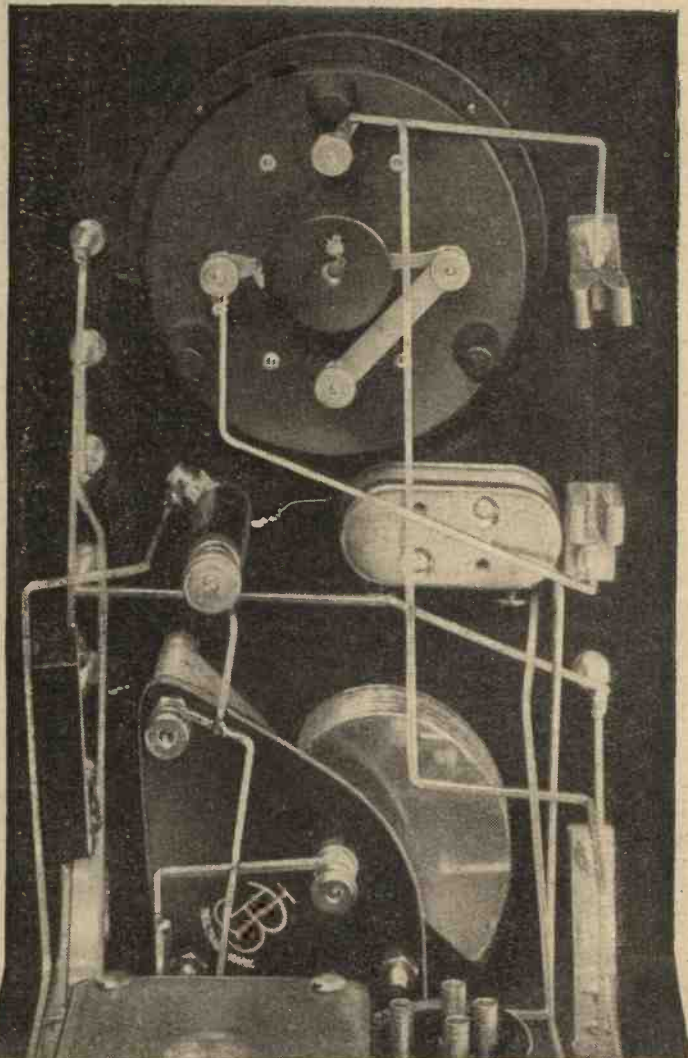

The wiring up of the variometer is perfectly straightforward.

.002  $\mu$ F condenser also replacing that of .001  $\mu$ F across the L.F. transformer secondary.

In some cases better results will be obtained by using a .003  $\mu$ F condenser across the variometer. The value of the condenser C4, will, to a certain extent, control the tone, but if it is increased much above .002-.003  $\mu$ F, volume begins to decrease. As an experiment a D.E. 5.B type of valve was tried and gave

German station was heard, and at various times a number of others weakly. This is only to be expected during the summer season, and no doubt as winter approaches the reception of other stations with a set of this type will improve very much. For receiving the local station at good strength on small aerials, up to about 30 miles distance, the receiver can certainly be recommended.



## Ideals & Realism

The world is in a hurry now-a-days. In no age has man wanted to make realities of ideals so quickly. Radio is one example. Constant improvement, perpetual research—and the result to-day is worthily shown by the perfection of Sterling components.

While there is no such thing as finality in progress, it is nevertheless true that Sterling components built into a set will provide a radio reproduction of a quality that leaves but little room, if any, for improvement.

Sterling components—by test, by comparison, by reputation—are admittedly supreme.

Ask your Dealer for List No. 373D.

N.A.R.M.A.T.  
WIRELESS EXHIBITION  
Royal Albert Hall  
Sept 12 to 23 1925  
*Come along to Stands 29/32*

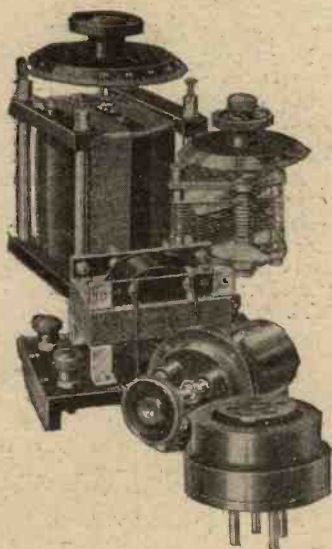
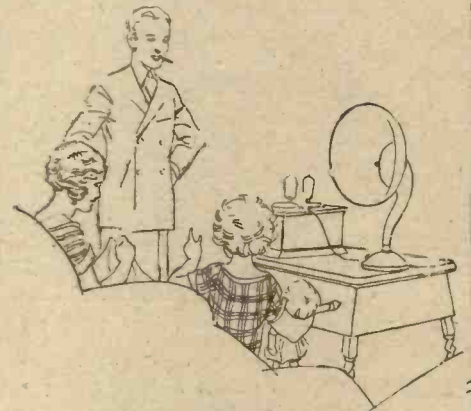

# for realism in radio — STERLING Components

Including :

High Grade Variometers, Square-Law Condensers, Intervalve Transformers, Reaction Units, Non-Pong Valve Holders, and every other conceivable component for the radio constructor.

## At your Radio Dealers.

Sole Agents; THE MARCONIPHONE COMPANY, LIMITED  
210-212, TOTTENHAM COURT ROAD, LONDON, W.1





## Quality and Distinction

**T**HE remarkable clarity and delightfully natural Tone of the world-famous AMPLION Loud Speaker when associated with a suitable Receiving Set render wireless reproduction comparable with the original performance.

With an AMPLION the unseen speaker, vocalist or orchestra, as the case may be, is brought right

into the Home, and the advantages of Radio Broadcast may be enjoyed to the very full.

In artistry of design and fine finish the AMPLION excels just as its efficiency is unapproached, so that the AMPLION may well be regarded as the one and only Wireless Loud Speaker for the Home of Beauty and Refinement.

The model illustrated here is the New "Dragon" AR 19 at £5 5s.

There is also a full range of other models for home use from 25/- to £3:10:0 without mentioning larger and more expensive demonstration types for use in halls or in the open air. Fully illustrated folder will be mailed on request, and demonstrations are gladly given during Broadcasting hours at the London Showrooms, 25, Savile Row, W.1, and the Suburban Showrooms, 82, High Street, Clapham, S.W.4.

Obtainable  
from  
AMPLION  
STOCKISTS  
and  
Wireless  
Dealers  
everywhere.

THE  
WORLD'S  
STANDARD

# AMPLION

WIRELESS  
LOUD  
SPEAKER

A visit to the  
AMPLION  
Stand at the  
Royal Albert  
Hall Radio  
Exhibition,  
will prove of  
great interest.

Patentees and Manufacturers:

ALFRED GRAHAM & CO. (E. A. GRAHAM),  
ST. ANDREW'S WORKS, CROFTON PARK, LONDON, S.E.4.



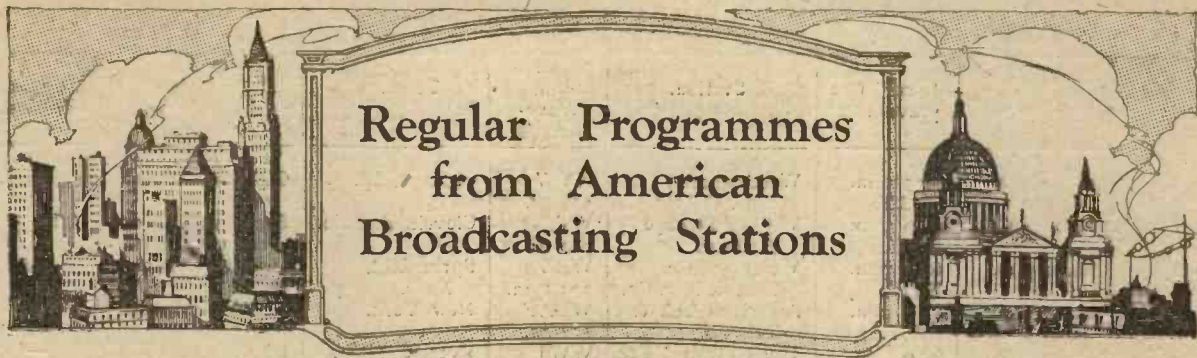

Regular Programmes  
from American  
Broadcasting Stations

Hours of transmission given in Greenwich Mean Time and in local time prevailing.

Telephony only. Corrected up to August 19. h, 1925.

Edited by Captain L. F. PLUGGE, B.Sc., F.R.Ae.S., F.R.Met.S.

Copyright.

WEEKDAYS.

No.	G.M.T.	Local Time prevailing.	Station.	Call Sign. Wave-length.	Town.	Nature of Transmission.	Approx. duration.
A. 63	1.15 a.m.	8.15 p.m. E.S.T.	Radio Lighthouse.	WEMC 286 m.	Berrien Springs, Mich.	Concert	1 1/4 hr
A. 4	1.45 a.m.	8.45 p.m. E.S.T.	Westinghouse Elec. & Mfg. Co.	KDKA 309 and 64 m.	Pittsburgh, Pa.	Dinner Concert or Organ Recital	1 1/2 hr.
A. 64	2.0 a.m.	9.0 p.m. E.S.T.	The Shepherd Stores.	WNAC 280.3 m.	Boston, Mass.	Concert.	2 hrs.
A. 21	2.55 a.m.	9.55 p.m. E.S.T.	John Wanamaker	WOO 508.2 m.	Philadelphia, Pa.	U.S. Naval Observatory Time Signal, followed by U.S. weather forecast.	—
A. 22	2.55 a.m.	9.55 p.m. E.S.T.	Westinghouse Elec. & Mfg. Co.	KDKA 309 and 64 m.	Pittsburgh, Pa.	Do. do.	—
A. 23	2.55 a.m.	9.55 p.m. E.S.T.	Do.	WBZ 333.1 m.	Springfield, Mass.	Do. do.	—
A. 24	3.0 a.m.	9.0 p.m. C.S.T.	Woodmen of the World.	WOAW 526 m.	Omaha, Nebraska.	Concert. (Ex. Wed.)	—
A. 28	3.0 a.m.	9.0 p.m. C.S.T.	Westinghouse Elec. & Mfg. Co.	KYW 536 m.	Chicago, Ill.	Musical entertainment sometimes begins 9.30 p.m. Tues., Wed. and Thurs.	1-2 hrs.
A. 82	4.0 a.m.	8.0 p.m. C.S.T.	"The Times."	KHJ 395 m.	Los Angeles.	Concert.	—
A. 68	4.0 a.m.	10.0 p.m. C.S.T.	Chicago Tribune Broadcasting Co.	WGN 370 m.	Chicago, Ill.	Dance Orchestra and popular songs (Mon. ex.)	1 hr.
A. 29	5.45 a.m.	11.45 p.m. C.S.T.	Kansas City Star.	WDAF 365.5 m.	Kansas City, Mo.	Musical Entertainment.	1 1/4 hr.
A. 27	3.30 a.m.	9.30 p.m. C.S.T.	Fort Worth Star Telegram.	WBAP 476 m.	Fort Worth, Texas.	Musical Programme (Ex. Sat.)	1 1/4 hr.

SUNDAYS.

A. 79	11.20 p.m.	6.20 p.m. E.S.T.	Chesapeake Tel. Co.	WCAP 465 m.	Washington, D.C.	Musical Programme and organ recital.	2 hrs.
A. 31	12.0 p.m.	6.0 p.m. C.S.T.	Woodmen of the World.	WOAW 526 m.	Omaha, Nebraska	Bible Study Hour	1 hr.
A. 30	12.0 p.m.	7.0 p.m. E.S.T.	Westinghouse Elec. & Mfg. Co.	KDKA 309 and 64 m.	Pittsburgh, Pa.	Divine Service.	1 hr.
A. 66	12.20 a.m.	7.20 p.m. E.S.T.	American Tel. & Tel. Co.	WEAF 492 m.	New York.	Musical Programme.	2 hrs.
A. 33	12.30 a.m.	7.30 p.m. E.S.T.	General Elec. Co.	WGY 379.5 m.	Schenectady, N.Y.	Church Service.	—
A. 32	12.30 a.m.	7.30 p.m. E.S.T.	Strawbridge & Clothier.	WFI 395 m.	Philadelphia, Pa.	Church Service.	—
A. 77	1.0 a.m.	7.0 p.m. C.S.T.	Sear-Roebuck & Co.	WLS 345 m.	Chicago, Ill.	Orchestra.	—



WEEKDAYS (Contd.)

No.	G.M.T.	Local Time prevailing.	Station.	Call Sign. Wave-length.	Town.	Nature of Transmission.	Approx. duration.
A. 14	11.35 p.m.	5.35 p.m. C.S.T.	Westinghouse Elec. & Mfg. Co.	KYW 536 m.	Chicago, Ill.	Children's Hour.	25 mins.
A. 1	11.0 p.m.	6.0 p.m. E.S.T.	Willard Storage Battery.	WTAM 389 m.	Cleveland, Ohio.	Dance Music, Concert, Orchestra.	1 hr.
A. 2	11.0 p.m.	6.0 p.m. E.S.T.	Westinghouse Elec. & Mfg. Co.	WBZ 333.1 m.	Springfield, Mass.	Dinner Concert.	30 min.
A. 65	11.0 p.m.	6.0 p.m. E.S.T.	American Tel. & Tel. Co.	WEAF 492 m.	New York.	Musical Programme	5 hrs.
A. 61	11.0 p.m.	6.0 p.m. E.S.T.	The Detroit News.	WWJ 352.7 m.	Detroit, Mich.	Dinner Concert.	—
A. 5	11.50 p.m.	5.50 p.m. C.S.T.	"Kansas City Star."	WDAF 365.6 m.	Kansas City, Mo.	Market, Weather, Time and Road Report.	10 min.
A. 80	Midnight.	7.0 p.m. E.S.T.	Gimble Bros.	WIP 508.2 m.	Philadelphia, Pa.	Children's Corner.	1 hr.
A. 6	Midnight.	6.0 p.m. C.S.T.	Kansas City Star	WDAF 365.6 m.	Kansas City, Mo.	Talks, Stories, Music.	1 hr.
A. 8	Midnight.	6.0 p.m. C.S.T.	Westinghouse Elec. & Mfg. Co.	KYW 365 m.	Chicago, Ill.	Dinner Concert.	30 min.
A. 66	Midnight.	6.0 p.m. C.S.T.	Chicago Tribune Broadcasting Co.	WGN 370 m.	Chicago, Ill.	Dinner Concert.	—
A. 3	11.15 a.m.	6.15 p.m. C.S.T.	Bamberger & Co.	WOR 405 m.	Newark, New Jersey.	Orchestra.	—
A. 9	Midnight.	7.0 p.m. E.S.T.	Goodyear Tyre and Rubber Co.	WEAR 390 m.	Cleveland, Ohio.	Concert (Except Saturday)	1 hr.
A. 12	Midnight.	6.0 p.m. C.S.T.	Woodmen of the World.	WOAW 526 m.	Omaha, Nebraska.	Talk or Concert.	—
A. 13	12.15 a.m.	7.15 p.m. E.S.T.	Westinghouse Elec. & Mfg. Co.	KDKA 309 and 64 m.	Pittsburgh, Pa.	News, Talk, Market Reports.	15 m.
A. 10	12.30 a.m.	7.30 p.m. E.S.T.	Westinghouse Elec. & Mfg. Co.	KDKA 309 and 64 m.	Pittsburgh, Pa.	Children's Hour.	—
A. 62	12.30 a.m.	7.30 p.m. E.S.T.	State College of Washington.	KFAE 526 m.	Pullman's, Washington.	Concert (Mon., Wed. and Fri.)	1½ hr.
A. 15	12.45 a.m.	7.45 p.m. E.S.T.	General Elec. Co.	WGY 379.6 m.	Schenectady, N.Y.	Music and/or Talks.	—
A. 16	1.0 a.m.	7.0 p.m. C.S.T.	Westinghouse Elec. & Mfg. Co.	KYW 536 m.	Chicago, Ill.	Talk, Concert, Musical Programme. (Mon. excepted).	2½ hr.
A. 17	1.0 a.m.	7.0 p.m. C.S.T.	Sears-Roebuck & Co.	WLS 345 m.	Chicago, Ill.	Children's Hour. (Mon. Ex.)	20 min.
A. 70	1.0 a.m.	7.0 p.m. C.S.T.	St. Louis Post Dispatch.	KSD 545.1 m.	St. Louis	Concert (Thurs., Silent).	2 hrs.
A. 11	1.15 a.m.	8.15 p.m. E.S.T.	Westinghouse Elec. & Mfg. Co.	WBZ 333.1 m.	Springfield, Mass.	Concert or Musical Programme.	30 min.
A. 19	1.30 a.m.	7.30 p.m. C.S.T.	Fort Worth Star Telegram	WBAP 476 m.	Fort Worth Texas.	Musical Programme (Ex. Saturday).	1 hr.
A. 81	2.0 a.m.	9.0 p.m. E.S.T.	American Radio Co.	KFQX 394 m.	Washington, D.C.	Concert. (Thurs., Silent).	—
A. 20	2.0 a.m.	8.0 p.m. C.S.T.	Kansas City Star.	WDAF 365.6 m.	Kansas City, Mo.	Musical Programme.	2 hrs.
A. 67	2.0 a.m.	8.0 p.m. C.S.T.	Chicago Tribune Broadcasting Co.	WGN 370 m.	Chicago, Ill.	Vocal and Instrumental music. (Ex. Mons.)	1 hr.
A. 72	2.0 a.m.	8.0 p.m. C.S.T.	Sears-Roebuck Co.	WLS 345 m.	Chicago, Ill.	Concert. (Except Mons. & Thurs.)	2½ hrs.
A. 73	3.0 a.m.	7.0 p.m. C.S.T.	KFL Radio Central Super Station.	KFI 467 m.	Los Angeles, Cal.	Musical Programme.	4 hrs.
A. 26	3.15 a.m.	7.15 p.m. C.S.T.	"Morning Oregon"	KGW 492 m.	Portland, Oregon.	Market, Weather, News, Police Reports.	—

EVERY EXPERIMENTER SHOULD READ

WIRELESS WEEKLY

ON SALE EVERY WEDNESDAY.

PRICE SIXPENCE.



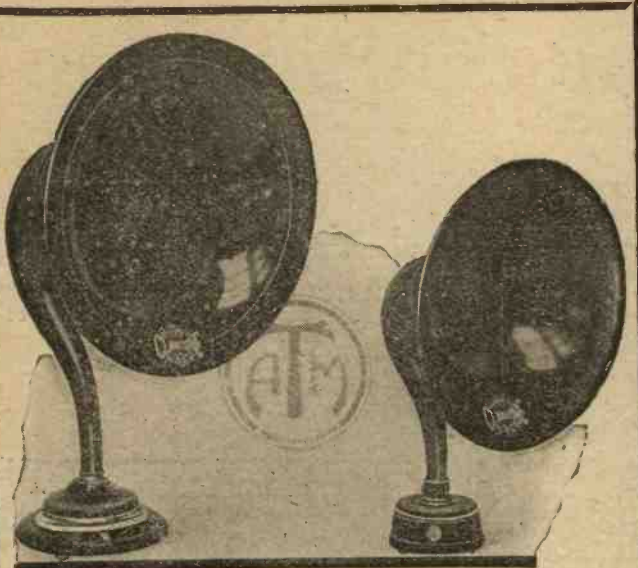

# CLARITONE LOUDSPEAKERS

enable you to appreciate the pleasure of perfect reception and to obtain that sweet purity of tone so dear to all music lovers. They stand unequalled in quality and service, and are recognised as a true example of faithful sound reproduction.

Fixed Prices for Season 1925-26

Senior Model  
Claritone

2000 ohms—W 290  
120 „ — „ 291  
£ 5 - 0 - 0

Junior Model  
Claritone

2000 ohms—W 295  
120 „ — „ 296  
£ 2 - 15 - 0

CLARITONE  
HEADPHONES

20/-

Supplied by all  
reputable dealers.



Sole Agents:

**ASHLEY WIRELESS  
TELEPHONE COMPANY**  
69 Renshaw Street, Liverpool

Telephone: 4628 Royal. Telegrams: "Rotary, Liverpool."

London and Southern Counties.

PETTIGREW & MERRIMAN, LTD.,  
122, Tooley Street, London, S.E.1



Fitted with the  
**100% Efficient  
Electron Emitting Filament**

**MOLYBDENUM  
THORIUM COVERED**  
(PATENTED)

Read about this wonderful  
valve and its achievements  
in our folders. Free to  
you on receipt of postcard.



FILAMENT VOLTS  
1.5 to 2.  
FILAMENT CURRENT  
3 amps.  
BRITISH MADE.  
B.B.C. STAMPED.

14/-

**ELECTRON**  
C<sup>o</sup> LTD

Phone: Regent 5356.  
TRIUMPH HOUSE, 189 REGENT  
STREET, LONDON, W.1.

If your dealer  
cannot supply  
send direct to  
us. Please give  
dealer's name  
and address

**HUNT'S**  
TRADE MARK

## HIGH-GRADE MEASURING INSTRUMENTS For All Purposes

We stock nearly 50 different types of measuring instruments totalling in all nearly 200 Calibrations, while any special reading or calibration can be supplied to exact requirements on request. Let us know what you require. We can help you!

Fig. 152 Double reading voltmeter, 0-7v. 0-100v. . . . .	Each 12/6
150 Pocket type voltmeter, 0-7v. 0-15v. or 0-25v. . . . .	7/6
151 Pocket type ampmeter, 0-25a. 0-15a or 0-25a. . . . .	7/6
133 Pocket type volt and ampmeter Each all readings . . . . .	10/6
160 Panel type voltmeter, 0-7v. 0-15v. or 0-25v. . . . .	9/-
161 Panel type ampmeter, 0-25a. 0-15a. or 0-25a. . . . .	9/-
165 Panel type voltmeter, 3 1/2 in. dial, calibrated 0-15 to 0-200v. . . . .	17/6 to 30/-
166 Panel type amperemeter, 3 1/2 in. dial, 0-15 or 0-25 amps. . . . .	17/6 to 19/-

Postage extra on above from

**A. H. HUNT, LTD.**  
(Dept. S.)  
TUNSTALL RD., CROYDON.

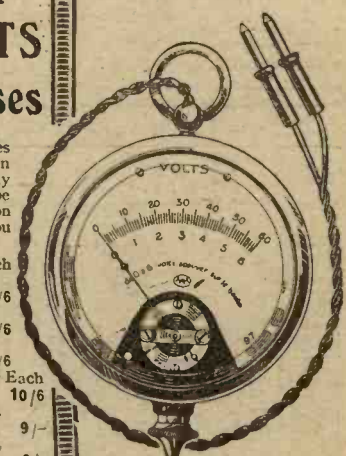

Fig. 152.  
Diam. of case 2 ins.  
**COMBINED VOLTMETER  
READING 0/7 VOLTS AND  
0/100 VOLTS.**  
Price 12/6 each.  
2 Spears are provided,  
one for each reading.



# The Magnadyne Super-Het



## 34 STATIONS ON THE LOUD SPEAKER!

These wonderful results were obtained on the Magnadyne by a well-known London doctor—many of them during daylight.  
 Prices, Kit of Components, £17 17 0.  
 M.O.D.E.3 Valves, 16/6 each.

The heart of a Super-Het is the Interfrequency Transformers and Oscillator Coupler, known as Magnafomers. Price per Outfit, including 5 Interfrequency Couplings and Interchangeable Oscillator Coupler, £5.  
 (Supplied on 7 days' approval against cash.)

Interchangeable Oscillator Couplers can be supplied at 12/6 each, or 15/- including 6 Pin Holder.

Magnum Anti-Capacity Valve Holders for Baseboard Mounting, 2/6 each.

### FOUR-VALVE HARMONY.

As described in this issue by Mr. Percy W. Harris.

	£	s.	d.
6 Magnum Vibro Valve Holders	1	10	0
1 Igranic Sq. Law Condenser, .0005	1	4	0
2 do. do. do. .0003	2	2	0
2 Magnum Aluminium Angle Brackets	0	3	0
1 Magnum Single Coil Holder	0	1	9

1 McMichael fixed Condenser and Clips, .0001	0	1	9
4 Polar Rheostats	3	2	0
1 Dorwood Condenser and Dubilier Leak, .0003	0	5	0
1 Dorwood Condenser and Dubilier Leak, .00025	0	5	0
1 T.C.C. Fixed Condenser, imfd.	0	3	4
1 McMichael L.F. Transformer with Condenser	1	2	9
1 Terminal Panel, with 7 Terminals, Drilled and Engraved	0	4	8
2 Magnum H.F. Transformers	0	14	0
1 Polar Vernier Condenser	0	5	6
8 Terminals, lacquered and complete	0	1	4
1 On and Off Switch	0	1	9
1 Set Radio Press Transfers	0	0	6
Screws, Soldering Tags and Flex	0	1	10
Cabinet, with Baseboard (Oak)	1	10	0
Polished Radion Panel, drilled	0	16	0

Note.—Where a complete set of components are purchased together, a Marconi Royalty of 12/6 per valve holder is payable.

The latest development in  
**SUPERSONIC - HETERODYNE**

Entirely British

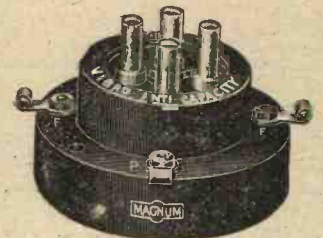

MAGNUM VIBRO VALVE  
 HOLDER.

Non-Microphonic, Anti-Capacity, No-Loss. As used in several Radio Press Sets 5/- each

Send stamp for lists and set of leaflets dealing with Radio Press Circuits, also the Magnadyne Super-Het.

**BURNE-JONES & CO., LTD.,**

MAGNUM HOUSE,  
 296, BOROUGH HIGH STREET, LONDON, S.E.1

Telephone: Hop 6257.  
 Telegrams: Burjomag, Sedist, London.  
 Cables: Burjomag, London.

Trade Enquiries Invited.

## "TURRET" MASTS

**COLUMBIAN TIMBER MASTS BY NAVAL EXPERTS.**

27 ft. Turret Two	£2 4 6	45 ft. Telescopic	- £4 10 6
38 ft. Complete	- 3 19 6	55 ft. "	- 6 15 6
42 ft. Telescopic	- 4 3 0	58 ft. super	- 6 19 6
40 ft. TURRET TWO	-		£2 18 9

SIMPSON & BLYTHE, 8-9, Sherwood St., Piccadilly W.

THIS IMPROVED **Athol** MEANS INSULATION

Ask for List of Athol Components.

## Reversible VALVE HOLDER

SPECIALLY SUITABLE FOR Baseboard Mounting

AND CAN BE USED BACK or FRONT of VERTICAL and HORIZONTAL PANELS.

We will send goods post free if you mention dealer's name.

**1/3 EACH**

**Athol ENGINEERING CO**  
 CORNET STREET, H<sup>2</sup> BROUGHTON, MANCHESTER



# A SIMPLE CRYSTAL SET

By

D.J.S. HARTT, B.Sc.



FOR enjoyable reception of broadcasting when great volume is not required and the use of headphones is not objected to, the humble crystal set has much to commend it. With the opening of the new high-power station at Daventry there are now few districts that are not within range of one of the broadcasting stations. For this reason the crystal set numbers among its adherents by far the greater number of broadcast listeners in this country.

### Varied Tastes

Many excellent designs have already been published, but new designs are constantly needed to satisfy the varied tastes of the ever-growing army of crystal users. The receiver illustrated in the photographs is neat and unobtrusive, and is particularly simple to construct, so that even the absolute novice need have no fear as to his ability to construct it and obtain results without any difficulty.

The components are mounted on a baseboard behind a vertical panel, with the exception of the condenser and the crystal detector, which are mounted on the panel for convenience in adjustment.

### The Circuit

The circuit is shown in Fig. 1 and will be seen to be of conventional type. Direct aerial coupling is employed, since it is only in rare cases that any benefit is derived from the use of any other form for crystal reception.

A low-loss type of coil is used, consisting of a single layer air-spaced winding, and provision is made for the use of a loading coil for the reception of 5XX in the usual manner. The tuning condenser has a capacity of  $.0003\mu\text{F}$ , since in most cases with the average broadcast aerial it is advantageous to increase the inductance of the coil and reduce the parallel tuning capacity.

### The Detector

The crystal detector is of the micrometer adjustment type enclosed in a glass cover to protect the crystal from dust. The usual catwhisker and sensitive galena is employed. With careful hand setting and if the set is not subjected to undue vibration, this probably gives the best results, and once a sensitive spot is found there should be no further need for re-adjustment during the course of a

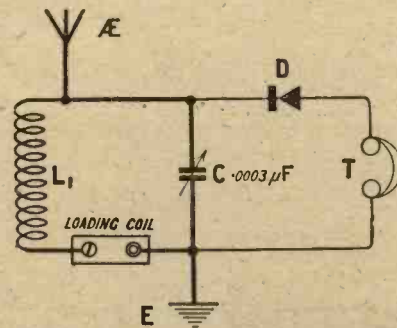

Fig. 1.—Direct coupling is used for both long and short wavelengths.

programme. Readers should not imagine, however, that a crystal will last for ever. It is even debatable whether the sensitivity of a given spot is not partly spoiled during the actual adjustment, however carefully it is made. Constant adjustment and scratching will not improve any crystal, and a fairly frequent renewal of the crystal is to be recommended.

A list of the actual components used in the construction of the set illustrated is given below for the guidance of those who have had little experience in set construction. Others more experienced have ample choice in the selection of suitable components if any departure from the original specification is contemplated.

One suitable cabinet (and baseboard 8 in. by 5 in. by  $\frac{3}{8}$  in.) (Camco).

One ebonite panel 8 in. by 6 in. by  $\frac{1}{4}$  in. (Paragon).

One standard low-loss former,  $3\frac{1}{2}$  in. diameter and preferably  $7\frac{1}{2}$  in. long (Collinson Precision Screw Co., Ltd.).

One  $.0003\mu\text{F}$  variable square-law condenser (Collinson Precision Screw Co., Ltd.).

One crystal detector for panel mounting (Burndept Wireless, Ltd.).

One single coil mount (for baseboard) and shorting plug (L. McMichael, Ltd.).

Four suitable terminals.

Radio Press panel transfers.

About  $\frac{1}{2}$  lb. No. 22 enamel insulated copper wire, square wire for wiring, screws, etc.

### Construction of the Coil

The first step in making the set should be confined to the construction of the coil. Here it may be mentioned that the standard  $3\frac{1}{2}$  in. former is a trifle too long to go into the cabinet. I have overcome this difficulty by countersinking the screws in the end rings so that there is just sufficient clearance. It will



be preferable when ordering to specify a former  $7\frac{1}{2}$  in. overall length in place of the illustrated length of about  $8\frac{1}{4}$  in. The former should be assembled with the aid of the screws provided, and the circular glass disc inserted in the centre of the winding space. Then secure the wire through the two small holes in one of the end rings and commence winding the first turn about four grooves from the ends of the threaded rods.

**Number of Turns**

The best number of turns will vary in individual cases, but intending constructors will not go far wrong if about 60 turns are wound on. In the actual coil shown in the photographs there are 70 turns, but this was designed for use on an aerial of rather small electrical characteristics. On an average aerial about 60 turns will be found adequate, with possibly 70 to 75 for stations between 400 and 500 metres (750—600 kc).

Probably the best plan is to wind on, say, 75 turns and take temporary tapings at the 50th, 60th and 70th, then determine by trial in reception what is the best number of turns. The remainder of the turns should then be stripped off and the end of the wire firmly secured through the small holes in the end ring, a

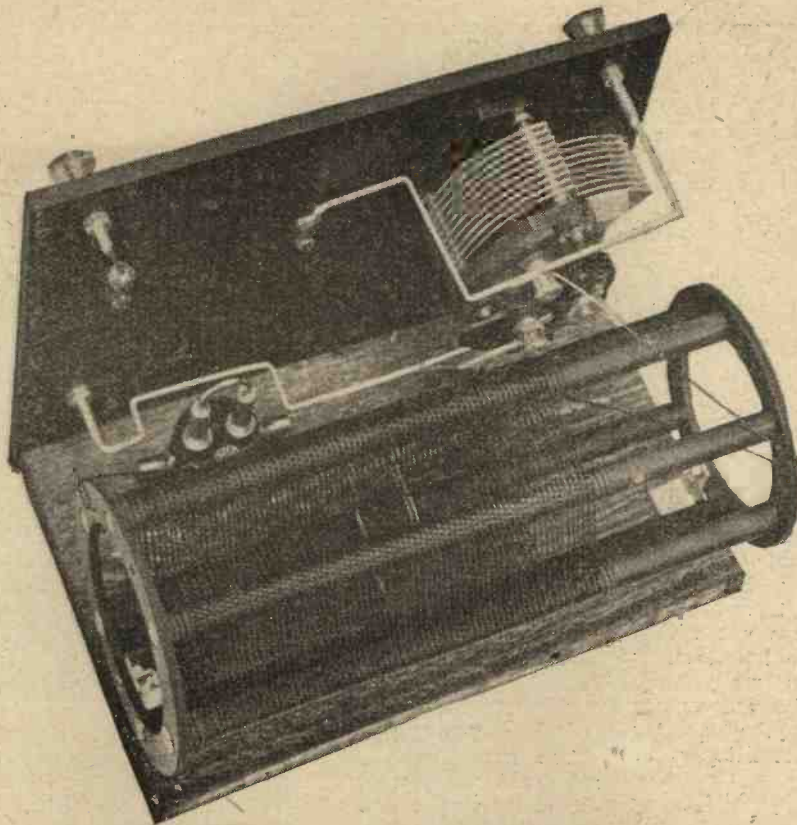

The loading coil socket for use when receiving Daventry is secured to the baseboard.

length of about 6 in. being left for connection purposes.

The coil is mounted at the

little distance above the baseboard. Messrs. Collinson also supply a bracket.

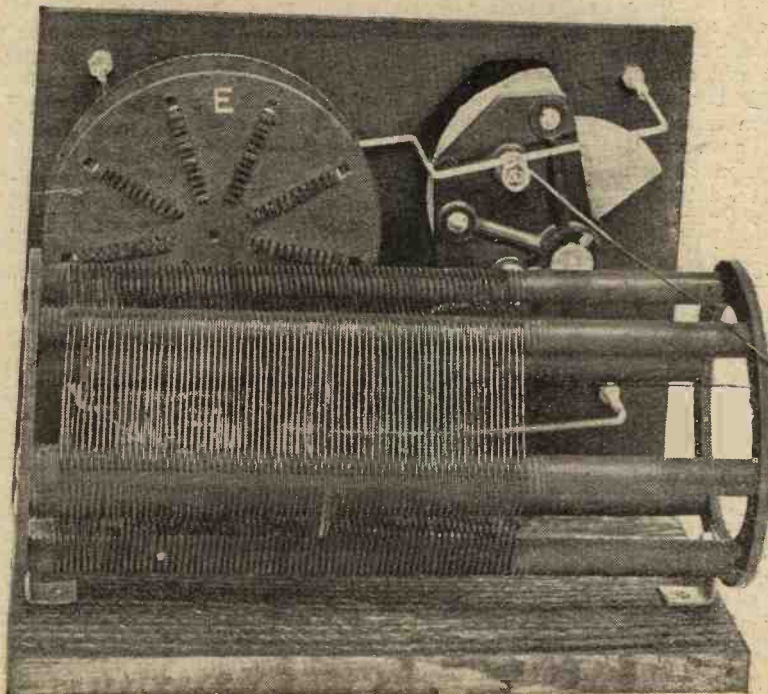

The winding of the coil is such that each turn is separated by air spacing from its neighbour.

back of the baseboard with the aid of two small brass L-shaped brackets, which are easily made out of odd pieces of scrap brass. A single 4 B.A. nut and bolt secures each bracket to the end ring of the former (through one of the holes already drilled in it) and a small brass wood screw through the other arm of each bracket fixes the whole to the baseboard. If the reader is unable to make the brackets himself, no doubt he will be able to obtain something suitable from the local ironmongers. All that is required is some form of bracket to support the coil rigidly some

Having made the coil, next mount the single coil socket, taking care that there is sufficient clearance so that the loading coil may be inserted without fouling anything.

The panels should next be marked out and drilled in accordance with the accompanying diagram. Marking out should be done from the back of the panel, bearing in mind that the apparent positions of the holes are reversed in this case. The layout given gives ample clearance for the components actually used; if any departure is made in this respect, however, the



# SUCCESS

## RADIO COMPONENTS



**EVERY** Success Radio Component is exactly what its name implies—super-excellence in every detail, efficiency in practical use, contributing to the utmost success of your radio at all times. Here we describe two Success products that have earned the greatest commendation of experienced radio men throughout the country. They can make a difference to your radio, too—the difference of vastly improved results.

**THE FAMOUS SUPER "SUCCESS" L.F. TRANSFORMER**

**I**N order to cut out the shrill and tinny timbre characteristic of many L.F. Transformers, we have designed the Super "Success" with a very high primary impedance.

the faithful musical reproduction which is the outstanding merit of the Super "Success." Each instrument is tested to 1,000 volts between the windings and between windings and frame; and is broadcast tested.

This is the secret of  
 Price 21/-

**THE "SUCCESS" SUPERFORMA**  
 A Super Het. I.F. Transformer designed to give results.

**O**UR own experiments only confirm the unsatisfactory design of the British H.F. Transformer for Coupling Valves in the Intermediate Frequency Long Wave Amplifier.

We have therefore designed a Radio Frequency Transformer with characteristics suitable for use with British Valves.

The "Success" Superforma covers a sufficiently wide wave-length band, so that long wave interference can be tuned out.

It conforms to desirable design; suitability to British Valves, ample wave-length range and is tunable.

It is adapted for base-board mounting; terminal connections provided.

Price 30/-  
 Obtainable from all  
 Wireless Dealers!

**BEARD and FITCH LTD.**  
 34, AYLESBURY STREET,  
 LONDON E. C. 1.

And at  
 1, Dean St., Piccadilly, Manchester.  
**SEE US AT STAND No. 23,**  
**N.A.R.M.A.T. EXHIBITION.**

**SUCCESS**

COMPONENTS



# FAMOUS FORMO PRODUCTIONS

THE NEW FORMO-DENSOR STRAIGHT WAVE, ULTRA LOW LOSS with 200-1 FINE TUNING RECORDING DIAL

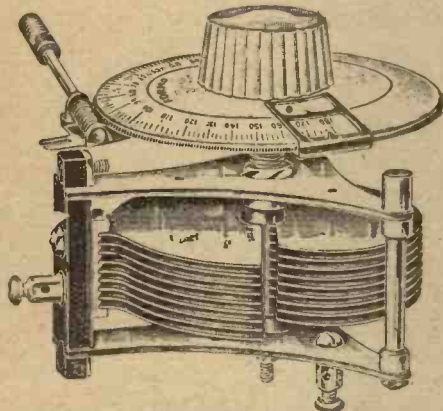

.0003μF .0005μF  
**FORMO-DENSOR**  
 complete with  
**FINE TUNING RECORDING DIAL**  
 17/6  
**FORMO-DENSOR**  
 without Dial.  
 10/6  
**FINE TUNING RECORDING DIAL**  
 separately  
 7/6

SEPARATES STATIONS WITH HAIR-SPLITTING EXACTITUDE

A Condenser of Advanced Design, Suitable alike for Laboratory and General Use, and for Super-Het., Neutrodyne and other Circuits designed for Super-Selectivity.

GROUNDING ROTOR, INDEPENDENT SKELETON FRAME, JEWELLERS' METAL VANES, NO HAND CAPACITY, STATIONS LOGGED ON THE DIAL.

## THE FORMO PERFECTION L.F. TRANSFORMER



Full, Rich, Mellow Reproduction of Voice or Music, with the Utmost Fidelity.  
**ITS STRONGEST APPEAL IS TO THE MOST CRITICAL.**

**ONE GUINEA**  
 30,000 Turns of Wire.

Correctly proportioned between the windings. On a core composed of the exact amount of iron.

### THE EVER POPULAR FORMO SHROUDED MODEL

12,500 Turns.

**10/6** Formerly 18/-

This transformer is increasing in favour by leaps and bounds, and, at the new price of 10/6, is undeniably the utmost value in Radio that money can buy.

It is giving honest and faithful service to thousands of listeners in every quarter of the globe.

ILLUSTRATED DESCRIPTIVE LEAFLETS ON REQUEST.

**THE FORMO COMPANY,**  
 (ARTHUR FREEMAN & CO., Ltd.)  
**CROWN WORKS,**  
 Cricklewood, London, N.W.2



# EFESCA ANTI-CAPACITY SWITCH

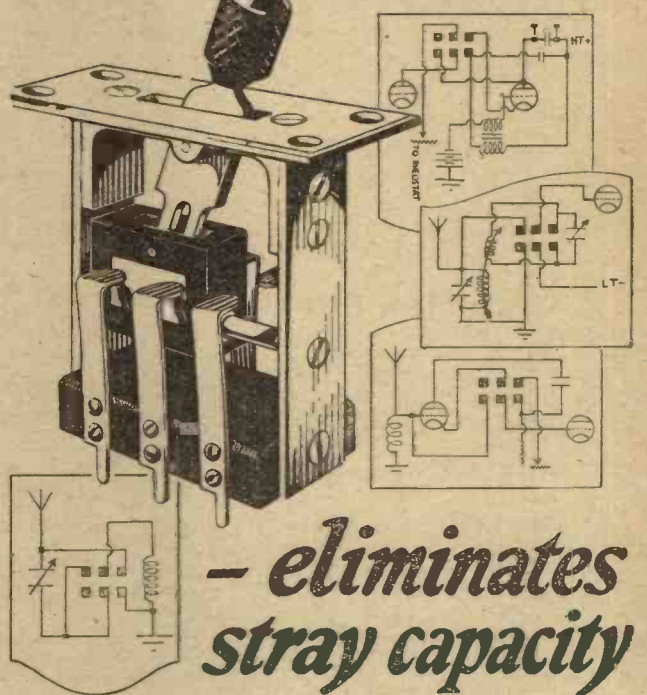

*- eliminates stray capacity*

A "no-loss" switch such as the EFESCA Anti-Capacity Switch is essential in detector and H.F. circuits if utmost results are to be achieved. In such circuits the self-capacity of ordinary switches is fatal to efficiency, and the EFESCA A.C. SWITCH has been designed with the one object of eliminating stray capacity. The contact strips are separated by a comparatively wide air-gap, and present only their edges to each other. It is typical of the technical superiority and instrument finish of

EFESCA Components are sold by all good Wireless Dealers and Electricians. **INSIST ON SEEING THE TRADE MARK.**



Write for complete catalogue describing EFESCA Components and Ef. seaphone Wireless Sets.

Wholesale Only:—

**FALK STADELMANN & CO., LTD.**

83-85-87, Farringdon Road,  
 London, E.C.1.

And at Glasgow, Manchester and Birmingham.

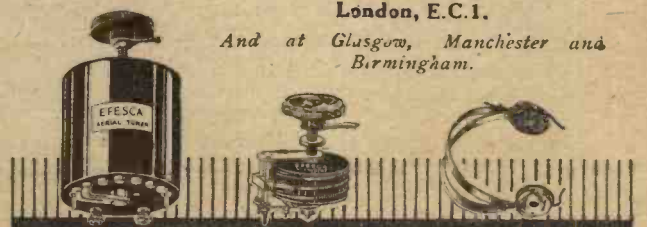

In replying to advertisers, use Order Form enclosed.



reader is warned that he should make quite certain that there is sufficient room for the components he selects.

In preparing the panel drill three holes in the correct positions, near the lower edge, for the three screws which secure the panel to the edge of the baseboard. Three  $\frac{5}{8}$  in. brass wood screws will be found to fix the panel quite rigidly in this manner.

Having mounted the condenser, terminals and crystal detector in this manner, attach the panel to the baseboard as indicated above. There now remains only the wiring to do to complete the receiver. For those who are unaccustomed to wiring a set from a circuit diagram, the accompanying wiring diagram will prove helpful.

Carefully solder all joins and use the minimum quantity of flux. All the soldering points are in accessible positions, so no difficulty should be experienced here.

**Testing the Set**

Connect up to your aerial and earth, attach the telephone receivers and endeavour to tune in your local station. If you are near one of the broadcasting stations in the lower wave band insert a shorting plug in the coil socket, otherwise if 5XX is the station you wish to receive plug in a No. 150 or 200 coil, or its equivalent. Assuming you

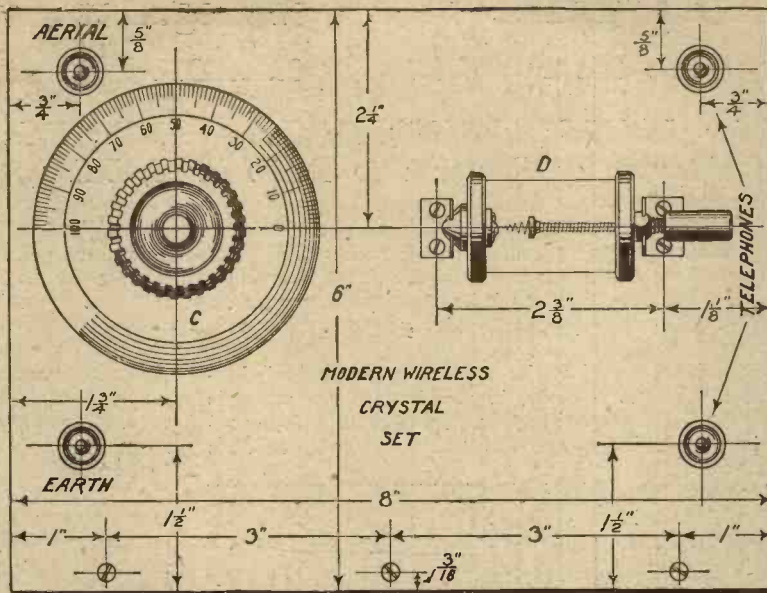

Fig. 2. The layout of the panel is simple and easily arranged.

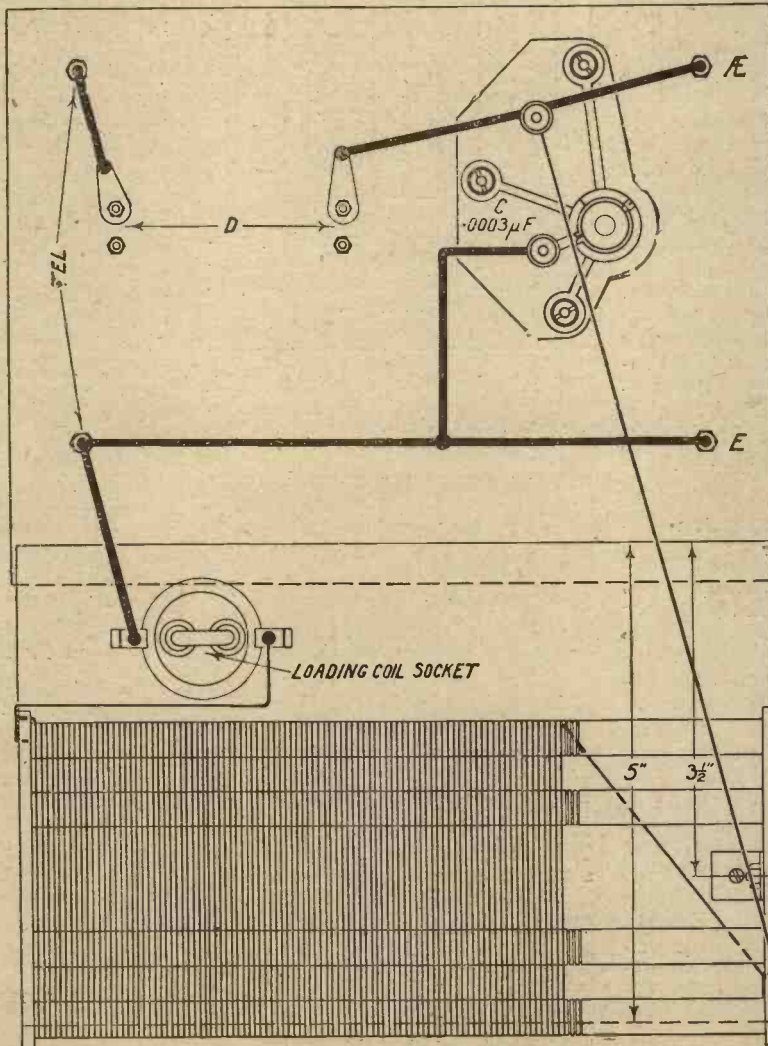

Fig. 3. To those readers who are unable to follow the theoretical circuit this wiring diagram will solve their difficulties.

are tuning to a station in the shorter wave band, after having set the catwhisker lightly on the crystal, vary the condenser until signals are heard. Then, as I suggested before, find the number of turns on the coil which gives you the best signals with a low condenser reading, say, about 30 degs. Once this is done proceed as indicated previously and make the connections to the coil permanent.

Up to a certain point it is an advantage in crystal reception to use a low-loss coil of type convenient, but beyond this there is nothing more to be gained by reducing coil losses any further.

**What to Expect**

The set as described above will give you very nearly the best signal strength possible with this circuit on a 300-600 metre station for crystal reception on an average P.M.G. aerial of fair efficiency and a good earth, and readers who construct it will, I think, be agreeably surprised at the results.

If your results are poor, however, and you have made the set quite correctly, do not blame the design until you have overhauled your aerial and earth system. A good aerial and earth are the first essentials before efficient crystal reception becomes possible.



# The New Importance of Super-Regenerative Circuits and their Operation

By Major JAMES ROBINSON, D.Sc., Ph.D., F.Inst.P.,  
Director of Research to Radio Press, Ltd.

*The sensitiveness of the super-regenerative receiver depends upon the difference between the fundamental and quenching frequencies, amplification being greater the greater the difference. For this reason the "super" circuit is becoming increasingly important in short-wave reception, and Dr. Robinson has carried out extensive practical investigation upon its use for this purpose.*

THE use of reaction to increase the strength of signals is well known.

A typical circuit is shown in Fig. 1, where the grid circuit AB is coupled to the aerial circuit CD. The anode circuit has a coil E which is capable of being coupled to the grid coil A. With the anode coil E far removed from the grid coil A, signals can be obtained, but when E is brought near to A signals can be increased in strength or decreased, according to the way in which the coil E is arranged. When the coil E is in the correct direction for amplification, the nearer it is brought to A the greater is the strength of signal. This increase in strength goes on increasing until a point is reached when the valve bursts into oscillation. Just before the point of oscillation, amplification is very large indeed, but it is not possible practically to use a circuit of this type in this very sensitive condition owing to its instability. This highly sensitive condition of a valve is so desirable that much work has been done in attempting to obtain stability of working.

### The Theory of Reaction

In order to appreciate how this has been done successfully, it is necessary to understand thoroughly what is happening in the simple circuit of Fig. 1. Impulses in the grid coil A from the aerial are amplified by the valve V, and these amplified impulses pass through the anode coil E. Coupling coil E to the grid coil A conveys part of these amplified impulses to the grid coil, and these will assist the primary impulses in this coil if the anode coil E is coupled in the correct way. Now, again these amplified impulses are amplified in the valve and again thrown back to the grid coil, and so on. More and more amplified energy can be thrown back by having a closer coupling between the anode and grid coils, until finally so much energy is thrown back for amplification again that once an

impulse is started, it goes on indefinitely, in which case the valve is oscillating. In Fig. 1 and subsequent figures two black dots

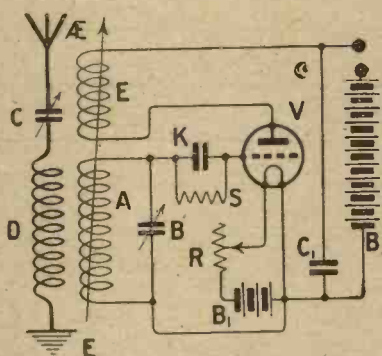

Fig. 1.—A simple reaction circuit. The two black dots indicate the telephone or output terminals.

indicate the output terminals which will usually have telephones connected across them.

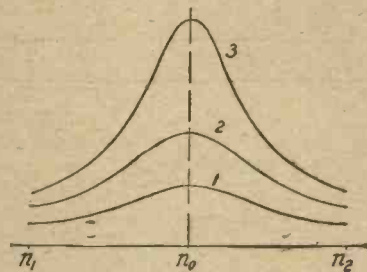

Fig. 2.—Resonance curves affected by damping assume the above shapes, a progressive increase in damping being indicated by curves 3 to 1.

### Super-Regenerative Effects

This gives a clear conception of how reaction can increase amplification, but in order to understand how the so-called super-regenera-

tion effects are produced, it is necessary to look at the matter in another way. In effect, the increase of reaction, or throw-back, is equivalent to diminishing the damping of the circuit. Damping is the effect which prevents things going on happening for ever. In electrical and wireless circuits, it is produced by resistance of the circuits, which consumes electrical energy, the word "resistance" being meant to cover many losses.

### Damping and Resonance

In any resonant circuit, damping has very pronounced effects. A resonant circuit being one which responds best to outside influences of the same frequency as itself, does more or less respond to other frequencies, the response being greater the nearer the frequencies are together. This is shown in the series of curves in Fig. 2, where it is seen that the curves have pronounced peaks, the height of the peaks corresponding to the amount of response in the resonant circuit. The different curves, 1, 2 and 3 are for different amounts of damping, curve 1 having the most, curve 2 less, and curve 3 least of all. As the damping gets less, the peak of the curve gets higher and higher, until for no damping at all it becomes theoretically infinite, although practical conditions naturally do place a limit on the response even for no damping.

### Signal Strength and Damping

Returning to the valve circuit of Fig. 1, the peaks of the curves correspond to the strength of signals that one obtains by increasing the coupling. It is seen that damping has the objectionable feature that it prevents the maximum signal strength being obtained, but that we cannot do without it altogether, for without it the valve will oscillate on its own accord.

### Grid Voltage

In Fig. 1 the back coupling was the only feature referred to for the



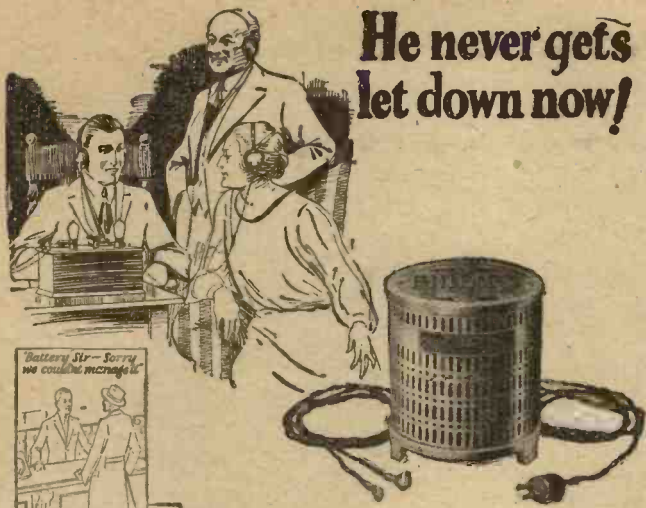

**He never gets  
let down now!**



That "bound-to-come" sort of feeling!

You know it and I know it, and one day it will come! No current; no wireless.

There's only one satisfactory solution—always have your accumulators ready charged, and when you think of chargers remember there is only one that will give complete satisfaction.

The Philips Rectifier works off any A.C. supply, requires no supervision whatever, works silently, and automatically regulates the current supply.

There are no objectionable chemicals, no buzzing noises, and you have in fact a most reliable battery feeder with an extraordinarily low running cost.

Simple, convenient, efficient.  
**It charges while you sleep.**

Write for leaflet M.W.  
free on application.

Trade enquiries invited.

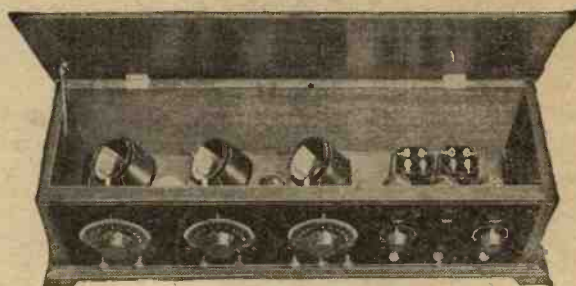

## Build your own Fada Neutrodyne

**I**F you know the Neutrodyne circuit you know its wonderful selectivity, range and volume. This circuit, usually very intricate in principle and construction, is made absolutely simple by the FADA set of components—*so simple you can build the complete 5-valve set in 2½ hours!*

This set is selective enough to cut out 2 LO in London and bring in Continental stations. It was fully described in "WIRELESS WORLD" May 27th.

With every outfit comes free the book "How to build a FADA Neutrodyne," of which over 200,000 copies have been sold all over the world.

Complete outfit as illustrated (Type 167a), without cabinet and valves, £10. If your local dealer does not stock it, write for descriptive literature.

*Mullard Valves, type D.F.A.I. with standard American base are recommended.*

**£4.150** COMPLETE

# PHILIPS RECTIFIER

Advt. Philips Lamps Ltd., 69, Wilson Street, London, E.C.2

# FADA Radio Ltd.

(Dept. A) 31, Kingsway, London, W.C.



# Super Economy B5

THE feature of the B5 Valve is that its current consumption is so small— $\frac{1}{16}$ th. of an ampere—that dry batteries of very small dimensions can be used. It is, therefore, the ideal valve for use in portable receivers, or wherever accumulators are undesirable or impracticable. As an all-round general purpose valve it is unsurpassed. Its electrical characteristics are given below:—

- Filament Voltage - - - 2.8 to 3 volts
- Filament Current - - 0.06 amp (at 3v.)
- Anode Voltage - - - 20 to 80 volts
- Anode Resistance - - - 17,000 ohms

PRICE  
**16/6**

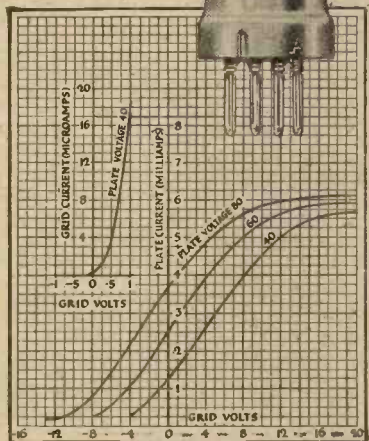

The B5 Valve is as good a detector and amplifier as any bright-emitter, but only takes  $\frac{1}{16}$ th as much current as the latter.

## B.T.H. Radio Valves

General Purpose		Power Amplifying	
<b>R</b>	Filament Voltage 4 Volts. Filament Current 0.7 Amp. Max. Plate Voltage 100 Volts.	<b>8/-</b>	<b>B4</b> Filament Voltage 6 Volts. Filament Current 0.25 Amp. Max Plate Voltage 120 Volts.
<b>B3</b>	Filament Voltage 1.8 Volts. Filament Current 0.35 Amp. Max Plate Voltage 80 Volts.	<b>14/-</b>	<b>B6</b> Filament Voltage 3 Volts. Filament Current 0.12 Amp. Max Plate Voltage 120 Volts.
<b>B5</b>	Filament Voltage 3 Volts. Filament Current 0.06 Amp. Max Plate Voltage 80 Volts.	<b>16/6</b>	<b>B7</b> Filament Voltage 6 Volts. Filament Current 0.06 Amp. Max Plate Voltage 120 Volts.

Insist on B.T.H.—the Best of ALL



Advertisement of The British Thomson-Houston Co. Ltd.



purpose of varying the amount of amplification, but naturally there is another very important feature, the operating grid voltage. This was shown of a fixed value in Fig. 1 by having the grid condenser and grid leak K and S. A means for varying the grid voltage can be obtained by substituting a potentiometer for the grid-leak and condenser.

**An Illustration**

The effect of the grid voltage on the conditions is by starting with a large negative value of the grid volts, say at A in Fig. 3, the valve will not oscillate, and there is a steady anode current of small value. Diminishing the negative volts, the steady anode current increases until a point is reached, say at B, where the valve starts to oscillate, assuming the back coupling is large enough. With this grid-voltage control it is thus possible to make the valve oscillate or not oscillate, as we wish, and again in approaching the oscillating condition the amplification is increased.

**Hysteresis**

There is a very undesirable feature about the influence of this grid voltage on the oscillating condition of a valve, and that is that usually on moving towards the oscillating condition, *i.e.*, towards the right in Fig. 3, the valve will start to oscillate at one value of grid volts, say B, but on moving back to stop the valve oscillating, it is necessary to move to another point. This undesirable feature is called hysteresis, or lag, and it contributes to the instability of the valve at or near the oscillating condition. It is possible to design circuits so that hysteresis is diminished considerably, and this problem will be discussed at a future date.

We are now in a position to understand the methods that are used to overcome the instability of the most highly sensitive condition of the valve.

Referring to Fig. 3, suppose the conditions are such that for grid voltage B the valve will commence to oscillate. Operating the valve with the grid volts just to the left of B will give very high amplifica-

tion. However, as soon as a signal arrives the oscillations of the signal will take the grid volts to the right of B, and then the valve will commence gradually to oscillate, the amplitude of these oscillations building up gradually. The rate at which they will build up will depend on the strength of the incoming signal, for a weak signal will only take the grid volts very slightly to the right

arrives it starts the valve oscillating, and then oscillations go on building up at a rate depending on the strength of the incoming signal. Before the limiting value of the oscillations is reached, our deliberate variation of the grid volts takes the mean grid volts to the left, and stops the oscillation altogether. Our next deliberate variation of the grid volts again takes the valve into the oscillating condition where the signal again causes the valve to start oscillating.

This allows the valve to oscillate to an amount depending on the strength of the incoming signal, and thus the result is that telephony can be received. This principle has been called Super-Regeneration by Armstrong, a claimant to the invention.

**Super-Regeneration**

The principle of super-regeneration has been described so far with the deliberate voltage oscillation applied to the grid. Another method, obviously, is to vary the anode volts periodically. If conditions are arranged so that for a particular grid potential and a particular anode voltage the valve is on the point of bursting into oscillation, then increasing the anode volts will produce oscillation, and diminishing the volts will stop it.

**Practical Conditions**

In practice the conditions to be obtained in order to achieve super-regeneration are a valve with its circuits so arranged that the point of oscillation can be easily found. It is usually necessary to put a certain amount of negative potential on the grid, though this depends on the valve used. There should be ample control of the reaction coil. Then some means of

applying a variable voltage to this valve are required, either to the grid or in series with the anode voltage. This frequency is best provided by another oscillating valve. For reception of telephony some attention must be given to the frequency employed. If it is anything below 10,000, this frequency will be heard as a note in the telephones or loudspeaker. It is thus advantageous to use a supersonic frequency for the reception of tele-

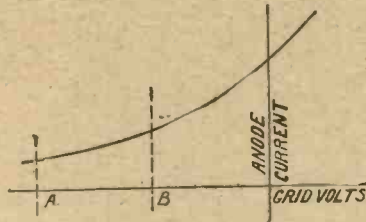

Fig. 3.—The grid-volts anode current curve referred to by the author in his explanation of hysteresis.

of B, whereas a strong signal may take the grid volts far to the right. Some time, though short, is required for the oscillations to build up to their limit. Some device is required to stop the oscillations reaching their limit, for if they do, then weak and strong signals alike will produce the same effect, and for the reception of telephony this will mean such distortion as to be actual chaos.

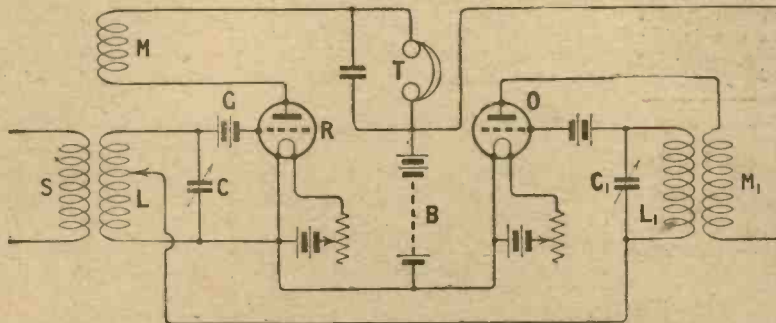

Fig. 4.—One of the simplest forms of the Armstrong Super-Regenerative Circuit. S is a coupling coil in the input circuit.

**An Effective Device**

One very effective device is to apply an oscillating voltage to the grid, at a much lower frequency than that of the incoming signal, of course. This causes the mean grid volts to vary from right to left with B in between. Thus, deliberately, we allow the valve to be in the oscillating condition, and then to be in the non-oscillating condition many times per second. When a signal



phony. On the other hand, this frequency should not be too high, as it should be as far removed from the frequency of the incoming waves as possible, so that as many oscillations of the incoming waves can take place as possible during the half period of the auxiliary frequency. The sensitiveness of the system depends on this difference in the two frequencies, being greater the greater the difference. For this reason super-regenerative circuits are most sensitive for the shortest waves.

**The Armstrong Circuit**

One of the simplest theoretical forms of the Armstrong super-regenerative circuits is shown in Fig. 4.

R is the super-regenerative valve which also serves as a detector. The grid circuit LC is tuned to the incoming waves and the anode coil M coupled to the grid coil in the usual way, this coupling being variable and the reaction being of large value.

The signals to be amplified are brought into the amplifying valve from the aerial, which might be a loop aerial, through the coupling SL. A grid battery G is included to make the grid negative. The anode circuit is completed through the telephones T and anode battery B to the filament of the valve R. The auxiliary oscillating valve O has its grid circuit  $L_1 C_1$  tuned to a frequency of about 10,000 for the reception of telephony, whilst the anode coil  $M_1$  is coupled to the grid coil  $L_1$ . This auxiliary oscillating valve circuit has the battery B

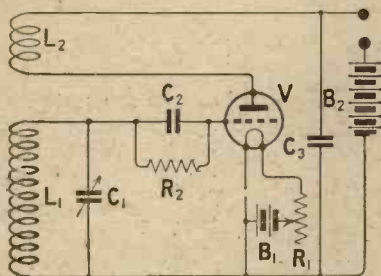

Fig. 5.—A typical oscillating circuit using a grid-leak and condenser.

common with the amplifying and detector valve. The auxiliary oscillating voltage is applied to the grid of the detector valve, by a connection from the filament of the oscillating valve to a variable contact on the grid coil L.

Other methods for obtaining stability of a regenerative circuit have

been used, whereby the means for stopping the valve oscillating are not produced by a different valve. One such method will be briefly referred to at the moment, and later much more will be said about such methods. The difference from the above method lies in the fact that a valve can be made to "oscillate" at two frequencies widely dif-

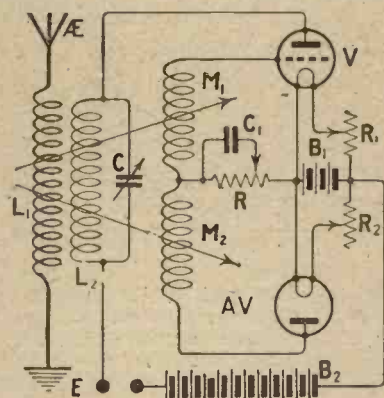

Fig. 6.—In this arrangement the two-electrode valve AV provides a quenching action.

ferent. A circuit such as shown in Fig. 5 is a simple oscillating circuit with a grid-leak  $R_2$  and grid condenser  $C_2$ . When the grid-leak is of a medium resistance, and the grid condenser not too large, the effect of this combination is to give a mean voltage to the grid which is suitable for maintaining the oscillations. For an ordinary receiving circuit, suitable values for  $C_2$  and  $R_2$  are  $0.02 \mu F$  and 100,000 ohms. If, however, the value of  $R_2$  is chosen to be high, say, of the order of 2 megohms, a very different state of affairs arises, and then a variable condition is produced, the grid being charged negatively at a rate too great for the grid-leak to deal with, thus causing the oscillation to cease, until the negative charge in the condenser has leaked away, when the

valve again starts to oscillate, and so on. The rate at which the grid is charged negatively and discharged is controlled by the values of the grid condenser and grid-leak. It is possible to make this rate anything from one or even less through the whole audible range to supersonic values of 10,000 and over. By such a system we thus have a valve "oscillating" at two frequencies, one very high, of wireless order, and the other comparatively low, of audible or supersonic values.

**Another Interesting Method**

A few methods of using such an oscillating combination have been used to obtain great amplification of signals. One such method will be briefly described, as it involves another interesting device. The object of this method is to have a valve which is on the point of performing the double oscillation just described, and the receipt of a signal starts the combined "oscillation." Extra means are provided to stop the system from oscillating by the actual signal itself, in other words, the actual grid voltage is controlled by the signal.

**A Further Circuit**

In Fig. 6, the circuit of Fig. 5 is repeated. In addition, however, there is an inductance  $M_2$  and a two-electrode valve AV. The inductance  $M_2$  is coupled to the aerial coil  $L_1$ , and it will be observed that  $M_2$  and the two-electrode valve are in parallel with the grid-leak and grid condenser. Oscillations induced in  $M_2$  are rectified by the two-electrode valve AV, and these rectified pulses act on the grid circuit of the valve V so as to make the grid negative. The rate at which this occurs depends on the strength of the incoming signal. Thus the grid is charged up in any case to the negative value required to stop the high frequency oscillation more quickly than if the two-electrode valve were not present.

\*\*\*\*\*  
 ORDER YOUR COPY OF  
 The New One-Word Weekly  
**"WIRELESS"**  
 No. 1  
 Will be out on September 15th.  
 PRICE - - TWOPENCE  
 \*\*\*\*\*



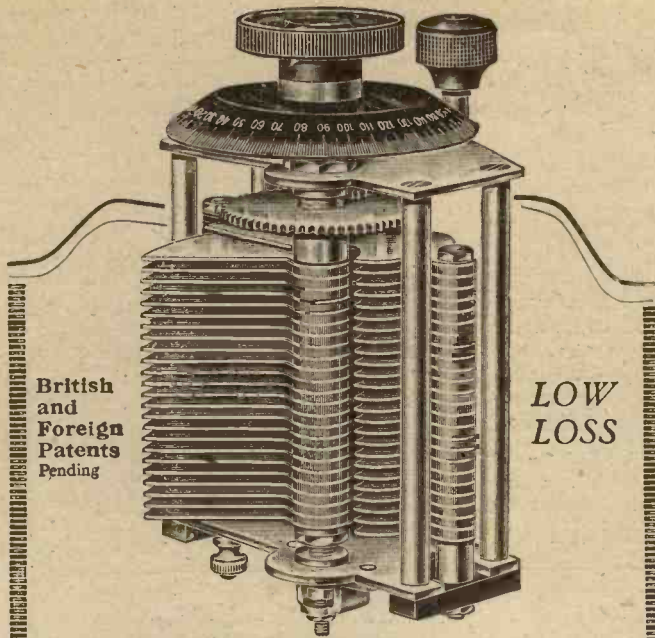

British and Foreign Patents Pending

LOW LOSS

## ANNOUNCING NEW MODELS J.B. CONDENSERS

THE name J.B. holds an enviable position in radio. Consistently from the earliest days the J.B. trade mark has been synonymous with better radio condensers. The new model J.B. Condensers here announced embody vital improvements, each of which is the outcome of our own practical experiments. They will perform thoroughly and in every way fulfil the high standard of quality and efficiency for which J.B. stands.

### FACTS WHICH PROVE CONCLUSIVELY THE SUPERIORITY OF THE J.B.

1. Correct Square Law Designs. Stator plates supported at 2 points only. Carefully insulated to reduce static field to a minimum.
2. Rigid frame cannot warp. Pigtail Connections eliminates noise and resistance through wiping contacts.
3. Dimensions reduced to reasonable limit to minimise skin effects.
4. GEARING GIVES REDUCTION OF 60 TO 1. CONTROLLED BY AMPLE SIZED KNOB TO ENSURE FINE TUNING. QUICK SEARCH CAN BE OBTAINED BY CENTRAL KNOB, TRULY, AN INSTRUMENT CONFORMING TO MODERN DESIGN AND ESSENTIAL FOR THE EFFICIENT FUNCTIONING OF MODERN RADIO RECEIVERS.

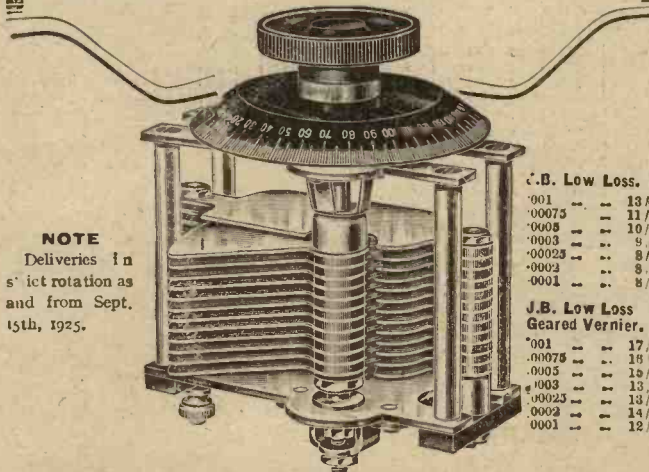

**NOTE**  
Deliveries in 5' tick rotation as and from Sept. 15th, 1925.

J.B. Low Loss.	
.001	13/6
.00075	11/9
.0005	10/6
.0003	9/-
.00025	8/9
.0002	8/3
.0001	8/3

J.B. Low Loss Gearing Vernier.	
.001	17/6
.00075	16/3
.0005	15/-
.0003	13/6
.00025	13/3
.0002	14/-
.0001	12/9

**JACKSON BROS.**  
8, POLAND ST - OXFORD ST  
LONDON - W.1. Telephone - GERRARD 7414  
(First Floor)

QUALITY **DUCO** SERVICE  
Recd

## Crystal Detectors

DUSTPROOF PATTERNS

Kindly order from your Wireless Dealer, We cannot supply direct

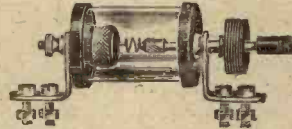

Enclosed Horizontal Type.  
List No. RC95/1 ... each 3/6

Enclosed Vertical Type.  
List No. RC95/2 ... each 4/3

With the advent of Daventry, Crystal Set users will outnumber the users of Valve Sets in this country by even greater numbers than hitherto. The demand for stable sets and parts will be great. The Crystal Detectors shown above which embody micrometer adjustment, can be recommended for stability. Absolute minute adjustment is possible.



**Brown Brothers**

— Allied Companies —  
THOMSON and BROWN BROTHERS, LTD.  
BROWN BROTHERS (Ireland), LTD.  
Wholesale only. Head Offices and Warehouses:  
GREAT EASTERN STREET, LONDON, E.C. 2.  
118, GEORGE ST., EDINBURGH. And Branches.

## INTRODUCING

A  
New  
Standard of  
Excellence



Price 31/6

Amplification... Absolutely Uniform and Considerably increased.

Every instrumental note both high & low distinguishable

Voice reproduction Absolutely Natural.

Guaranteed 12 Months. No distortion.

Shrouded with Electrolytic Copper.

Bobbin of pure Vulcanized Rubber.

Terminals moulded in bobbin flange. No loose wires.

Nearly three miles of wire used in construction.

The  
"POWQUIP"  
INTERVALVE TRANSFORMER  
"ORCHESTRAL"

POWER EQUIPMENT COMPANY LIMITED.  
KINGSBURY WORKS, THE HYDE, HENDON, LONDON, N.W.9.



# A Table for Superheterodyne Users

## Conversion from Metres to Kilocycles.

THE table below is of particular value to all experimenters with the supersonic heterodyne receiver, as it shows the differences in kilocycles (thousands of cycles) between the different frequencies corresponding to the wavelengths used in broadcasting.

Thus, if the intermediate frequency used is 60,000, then a wavelength of 380 metres must be combined with a wave of about 353 metres to give this desired beat frequency. Reasons of space make it possible to give only the frequency for each ten metres (or more on the longer

waves), but intermediate frequencies are easily interpolated. For the convenience of readers there will be found on page 843 a list of the main stations received in this country, their wavelengths in metres and the corresponding frequencies being shown.

### KILOCYCLES TO METRES, OR METRES TO KILOCYCLES.

Metres	Kilocycles	Metres	Kilocycles	Metres	Kilocycles	Metres	Kilocycles	Metres	Kilocycles	Metres	Kilocycles	Metres	Kilocycles
10	2999.2	730	410.7	1450	206.8	2170	138.2	2890	103.7	4220	71.05	6650	45.09
20	1499.1	740	405.2	1460	205.4	2180	137.5	2900	103.4	4240	70.71	6700	44.75
30	999.4	750	399.8	1470	204.0	2190	136.9	2910	103.0	4260	70.38	6750	44.43
40	749.6	760	394.5	1480	202.6	2200	136.3	2920	102.7	4280	70.05	6800	44.09
50	599.8	770	389.4	1490	201.2	2210	135.7	2930	102.3	4300	69.73	6850	43.77
60	499.7	780	384.4	1500	199.9	2220	135.1	2940	102.0	4320	69.40	6900	43.45
70	428.3	790	379.5	1510	198.6	2230	134.4	2950	101.6	4340	69.08	6950	43.14
80	374.8	800	374.8	1520	197.3	2240	133.8	2960	101.3	4360	68.77	7000	42.83
90	333.1	810	370.1	1530	196.0	2250	133.3	2970	100.9	4380	68.45	7050	42.53
100	299.8	820	365.6	1540	194.7	2260	132.7	2980	100.6	4400	68.14	7100	42.23
110	272.8	830	361.2	1550	193.4	2270	132.1	2990	100.3	4420	67.83	7150	41.93
120	249.9	840	356.9	1560	192.2	2280	131.5	3000	99.94	4440	67.53	7200	41.64
130	230.6	850	352.7	1570	191.0	2290	130.9	3020	99.28	4460	67.22	7250	41.35
140	214.2	860	348.6	1580	189.8	2300	130.4	3040	98.62	4480	66.92	7300	41.07
150	199.9	870	344.6	1590	188.6	2310	129.8	3060	97.98	4500	66.63	7350	40.79
160	187.4	880	340.7	1600	187.4	2320	129.2	3080	97.34	4520	66.33	7400	40.52
170	176.4	890	336.9	1610	186.2	2330	128.7	3100	96.72	4540	66.04	7450	40.24
180	166.6	900	333.1	1620	185.1	2340	128.1	3120	96.10	4560	65.75	7500	39.98
190	157.8	910	329.5	1630	183.9	2350	127.6	3140	95.48	4580	65.46	7550	39.71
200	149.9	920	325.9	1640	182.8	2360	127.0	3160	94.88	4600	65.18	7600	39.45
210	142.8	930	322.4	1650	181.7	2370	126.5	3180	94.28	4620	64.90	7650	39.19
220	136.3	940	319.0	1660	180.6	2380	126.0	3200	93.69	4640	64.62	7700	38.94
230	130.4	950	315.6	1670	179.5	2390	125.4	3220	93.11	4660	64.34	7750	38.69
240	124.9	960	312.3	1680	178.5	2400	124.9	3240	92.54	4680	64.06	7800	38.44
250	119.9	970	309.1	1690	177.4	2410	124.4	3260	91.97	4700	63.79	7850	38.19
260	115.3	980	305.9	1700	176.4	2420	123.9	3280	91.41	4720	63.52	7900	37.95
270	111.0	990	302.8	1710	175.3	2430	123.4	3300	90.85	4740	63.25	7950	37.71
280	107.1	1000	299.8	1720	174.3	2440	122.9	3320	90.31	4760	62.99	8000	37.48
290	103.4	1010	296.9	1730	173.3	2450	122.4	3340	89.77	4780	62.72	8050	37.24
300	999.4	1020	293.3	1740	172.3	2460	121.9	3360	89.23	4800	62.46	8100	37.01
310	967.2	1030	291.1	1750	171.3	2470	121.4	3380	88.70	4820	62.20	8150	36.79
320	936.9	1040	288.3	1760	170.4	2480	120.9	3400	88.18	4840	61.95	8200	36.56
330	908.5	1050	285.5	1770	169.4	2490	120.4	3420	87.67	4860	61.69	8250	36.34
340	881.8	1060	282.8	1780	168.4	2500	119.9	3440	87.16	4880	61.44	8300	36.12
350	856.6	1070	280.2	1790	167.5	2510	119.5	3460	86.65	4900	61.19	8350	35.91
360	832.8	1080	277.6	1800	166.6	2520	119.0	3480	86.16	4920	60.94	8400	35.69
370	810.3	1090	275.1	1810	165.6	2530	118.5	3500	85.66	4940	60.69	8450	35.48
380	789.0	1100	272.6	1820	164.7	2540	118.0	3520	85.18	4960	60.45	8500	35.27
390	768.8	1110	270.1	1830	163.8	2550	117.6	3540	84.69	4980	60.20	8550	35.07
400	749.6	1120	267.7	1840	162.9	2560	117.1	3560	84.22	5000	59.96	8600	34.86
410	731.3	1130	265.3	1850	162.1	2570	116.7	3580	83.75	5050	59.37	8650	34.66
420	713.9	1140	263.0	1860	161.2	2580	116.2	3600	83.28	5100	58.79	8700	34.46
430	697.3	1150	260.7	1870	160.3	2590	115.8	3620	82.82	5150	58.22	8750	34.27
440	681.4	1160	258.5	1880	159.5	2600	115.3	3640	82.37	5200	57.66	8800	34.07
450	666.3	1170	256.3	1890	158.6	2610	114.9	3660	81.92	5250	57.11	8850	33.88
460	651.8	1180	254.1	1900	157.8	2620	114.4	3680	81.47	5300	56.57	8900	33.69
470	637.9	1190	251.9	1910	157.0	2630	114.0	3700	81.03	5350	56.04	8950	33.50
480	624.6	1200	249.9	1920	156.2	2640	113.6	3720	80.60	5400	55.52	9000	33.31
490	611.9	1210	247.8	1930	155.3	2650	113.1	3740	80.17	5450	55.01	9050	33.13
500	599.6	1220	245.8	1940	154.5	2660	112.7	3760	79.74	5500	54.51	9100	32.95
510	587.9	1230	243.8	1950	153.8	2670	112.3	3780	79.32	5550	54.02	9150	32.77
520	576.6	1240	241.8	1960	153.0	2680	111.9	3800	78.90	5600	53.54	9200	32.59
530	565.7	1250	239.9	1970	152.2	2690	111.5	3820	78.49	5650	53.07	9250	32.41
540	555.2	1260	238.0	1980	151.4	2700	111.0	3840	78.08	5700	52.60	9300	32.24
550	545.1	1270	236.1	1990	150.7	2710	110.6	3860	77.67	5750	52.14	9350	32.07
560	535.4	1280	234.2	2000	149.9	2720	110.2	3880	77.27	5800	51.69	9400	31.90
570	526.0	1290	232.4	2010	149.2	2730	109.8	3900	76.88	5850	51.25	9450	31.73
580	516.9	1300	230.6	2020	148.4	2740	109.4	3920	76.48	5900	50.82	9500	31.56
590	508.2	1310	228.9	2030	147.7	2750	109.0	3940	76.10	5950	50.39	9550	31.39
600	499.7	1320	227.1	2040	147.0	2760	108.6	3960	75.71	6000	49.97	9600	31.23
610	491.5	1330	225.4	2050	146.3	2770	108.2	3980	75.33	6050	49.56	9650	31.07
620	483.6	1340	223.7	2060	145.5	2780	107.8	4000	74.96	6100	49.15	9700	30.91
630	475.9	1350	222.1	2070	144.8	2790	107.5	4020	74.58	6150	48.75	9750	30.75
640	468.5	1360	220.5	2080	144.1	2800	107.1	4040	74.21	6200	48.36	9800	30.59
650	461.3	1370	218.8	2090	143.5	2810	106.7	4060	73.85	6250	47.97	9850	30.44
660	454.3	1380	217.3	2100	142.8	2820	106.3	4080	73.49	6300	47.59	9900	30.28
670	447.5	1390	215.7	2110	142.1	2830	105.9	4100	73.13	6350	47.22	9950	30.13
680	440.9	1400	214.2	2120	141.4	2840	105.6	4120	72.77	6400	46.85	10000	29.98
690	434.5	1410	212.6	2130	140.8	2850	105.2	4140	72.42	6450	46.48		
700	428.3	1420	211.1	2140	140.1	2860	104.8	4160	72.07	6500	46.13		
710	422.3	1430	209.7	2150	139.5	2870	104.5	4180	71.73	6550	45.77		
720	416.4	1440	208.2	2160	138.8	2880	104.1	4200	71.39	6600	45.43		



## Appreciations from Readers and Some Results Obtained with Radio Press Sets

### Mr. Simpson's Single-valve Receiver

SIR,—You may be interested in the following report of that excellent single-valve receiver described by Mr. Herbert K. Simpson in the January, 1925, issue of MODERN WIRELESS.

Using a Marconi D.E.3 valve, Burndept coils, S 5 in reaction, S 4 in the aerial, 30 V. high tension, condenser in parallel, the following results are obtained with comparative uniformity from day to day:—

Birmingham (seven miles away, signals perfectly pure and very strong, sufficiently so to work a loudspeaker); Chelmsford (on Burndept 250 and 200 coils, was very loud and clear, although 130 miles away).

These stations are mentioned because on no previous single valve circuit have I obtained such volume with purity.

As to distant stations, the following can be picked up day or night when transmitting.

2LO (clear, and fair strength); Cardiff (clear, and fair); Manchester (clear, good strength); Brussels (clear and good); Bournemouth (clear, good strength); Nottingham (clear, and loud); Hamburg (clear, loud strength); Petit Parisien (clear, and loud); Madrid (clear, moderate).

Other British and European stations have been received, but those noted can be tuned in with certainty, which I am convinced is exceptional on a single valve without distortion.

This set has surprised me in many ways, for with no earthing system whatever, I can tune in 2LO, Manchester, Bournemouth, Bournemouth, Daventry, Radio-Paris,

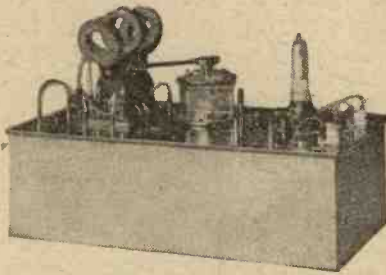

The set referred to by Mr. Bayliss.

and other British stations at a signal strength only slightly inferior to that obtained with the earth connected, and certainly at a strength equal to most one-valve sets I have heard with the ordinary aerial and earth arrangements.

Of course I am delighted with the circuit, and although I have practically completed Mr. Percy W. Harris's Anglo-American Six (*The Wireless Constructor* for January, 1925) from which I anticipate good results, I should be loth to supersede a receiver which is so simple, and yet so effective.—Yours truly,

L. A. BAYLISS.

Birmingham.

### A Four Valve T.A.T.

SIR—No doubt you will be interested to learn of the results I have obtained with the T.A.T. Four, published by Mr. John Scott-Taggart, in the December issue, 1924, of MODERN WIRELESS. I had practically given up H.F. amplification in disgust, especially after having built and got good results on a three valve portable (D. and 2 L.F.)

set described some time ago in MODERN WIRELESS. Incidentally this set receives quite a batch of B.B.C. stations on the loudspeaker. However, after reading your excellent articles on the T.A.T. system, I decided to build the four valver.

To give the set a thorough test, I tested it out on four yards of single wire used as an inside aerial on the ground-floor, and I was successful in receiving several B.B.C. stations at good 'phone strength.

In conclusion, may I congratulate you on designing a really efficient method of H.F. amplification.—Yours truly,

H. LESLEY OVEREND.

Eccleshill, Bradford.

### Envelope No. 3.

SIR,—I have made a Simplicity 3-valve set as described by Mr. Kendall in Envelope No. 3. I have had first-class results with same. I am able to receive concerts from the Continent as clear as the London station. I am hoping to get WGY, America, in the future. The lucid description contained within the envelope, as to the building of this receiver is a great credit to the author.

Yours truly,

F. C. WEST.

Ramsgate.

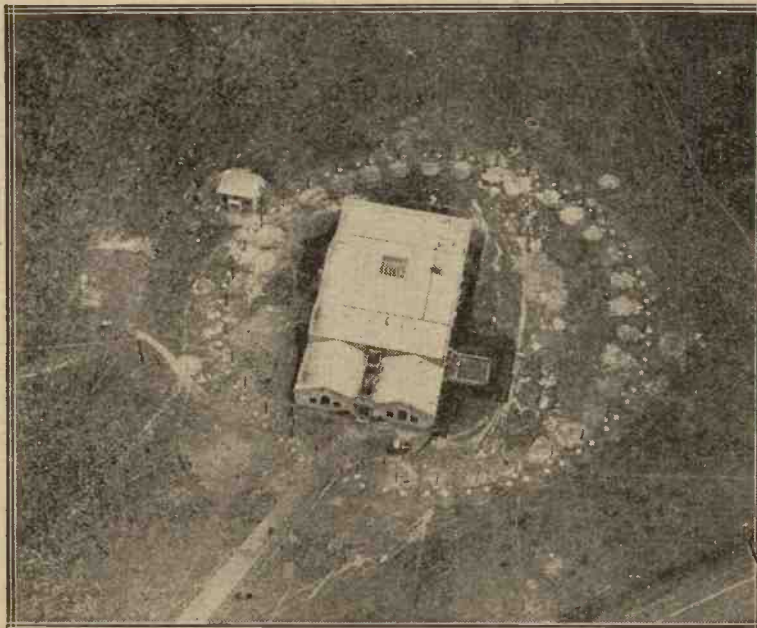

The Daventry Station as seen from the air, showing the circle of earth plates. The small building on the left is the transformer sub-station.



# Call Signs

## For British Experimental Transmitting Stations Revised to August 19th, 1925

Owing to the fact that we are informed by the Post Office that the three-letter call signs are only allotted to artificial aerial systems, these have been purposely omitted. Every endeavour has been made to bring this list up to date, and those experimenters whose call signs are of more recent issue are invited to send particulars to the Editor for inclusion in subsequent lists.

### 2 A

- 1 AA THE RADIO COMMUNICATION Co., LTD. Slough, Bucks.
- 2 AB J. O. WALKER ... 16, Ash Road, Headingley, Leeds.
- 2 AC METROPOLITAN-VICKERS ELECTRICAL CO., LTD. Research Dept., Trafford Park, Manchester.
- 2 AD
- 2 AE
- 2 AF
- 2 AG T. MOOR ... Castlemaine, Lethbridge Road, Southport, Lancs.
- 2 AH
- 2 AI
- 2 AJ THE RADIO COMMUNICATION Co., LTD. (Works) 67, High Street, Barnes.
- 2 AK
- 2 AL W. HALSTEAD ... "Briar Royd," Briar Lane, Thornton-le-Fyde.
- 2 AM A. PERL, B.Sc. ... Victoria House, York Road, Hove, Sussex.
- 2 AN
- 2 AO OWEN H. KELLY ... 26, Junction Road, Eastbourne.
- 2 AP
- 2 AQ
- 2 AR EDGAR GAZE ... 3, Archibald Street, Gloucester.
- 2 AS Capt. W. HARWOOD MOON 69, Coleridge Avenue, Penarth, nr. Cardiff.
- 2 AT
- 2 AU ALFRED C. BULL ... 25, Fairland Road, West Ham, E.
- 2 AV
- 2 AW
- 2 AX GEORGE SUTTON, A.M.I.E.E., F.R.A. 5, Church Road, Forest Hill, S.E.
- 2 AY D. F. OWEN ... Limehurst, Sale, Cheshire (Portable station).
- 2 AZ WILLIAM LE QUEX, M.I.R.E. 93, Marina, St. Leonards-on-Sea (Research work only).

### 2 B

- 2 BA
- 2 BB
- 2 BC D. F. OWEN ... Limehurst, Sale, Cheshire.
- 2 BF
- 2 BG
- 2 BH G. W. WIGGLESWORTH ... 90, Blenheim Road, Barnsley.
- 2 BI Lt.-Col. W. S. PALMER ... Elm Field, Calne, Wiltshire.
- 2 BJ
- 2 BK
- 2 BL
- 2 BM H. L. GARFATH ... 218, Morland Road, Croydon, Surrey.
- 2 BN
- 2 BO MARCONI'S WIRELESS TELEGRAPH CO., LTD. Writtle, Essex.
- 2 BP
- 2 BQ
- 2 BR
- 2 BS
- 2 BT
- 2 BU
- 2 BV
- 2 BW
- 2 BX
- 2 BY
- 2 BZ BASIL DAVIS (Grad. I.E.E.)... 23, Ferncroft Avenue, N.W. 3.

### 2 C

- 2 CA C. E. PALMER JONES ... 20, Princes Road, Wimbledon, S.W.
- 2 CA C. E. PALMER JONES ... Willesden, N.W. 10.
- 2 CA C. E. PALMER JONES ... Portable.
- 2 CB
- 2 CC
- 2 CD BURTON WIRELESS SOCIETY High Street, Burton-on-Trent.
- 2 CE
- 2 CF
- 2 CG
- 2 CH
- 2 CI
- 2 CJ
- 2 CK CITY AND GUILDS (ENGINEERING) COLLEGE Exhibition Road, S.W. 7.
- 2 CL

- 2 CM NORMAN D. B. HYDE ... 92, Litledale Road, Egremont, Wallasey, Cheshire.
- 2 CN
- 2 CO
- 2 CP
- 2 CQ
- 2 CR
- 2 CS
- 2 CT
- 2 CU
- 2 CV
- 2 CW
- 2 CX
- 2 CY
- 2 CZ CYRIL T. ATKINSON... 17, Beaumont Road, Leicester.

### 2 D

- 2 DA
- 2 DB
- 2 DC MAURICE CHILD ... 60, Ashworth Mansions, Maidland, W. 9.
- 2 DD ARTHUR C. DAVIS ... 105, Brynland Avenue, Bristol.
- 2 DF R. E. MILLER ... Strathdene, 77, King's Avenue, New Malden, Surrey.
- 2 DG
- 2 DH
- 2 DI
- 2 DJ A. T. LEE ... Alvaston, Derby.
- 2 DK
- 2 DL
- 2 DM
- 2 DN M. N. DURNFORD ... Kingswear House, Kingswear, S Devon
- 2 DO
- 2 DP
- 2 DQ
- 2 DR S. R. WRIGHT, A.M.I.R.E. ... 14, Bankfield Drive, Nab Wood, Shipley, Yorks.
- 2 DS
- 2 DT
- 2 DU W. D. NORBURY ... 51, Chilwell Road, Beeston, Notts.
- 2 DV Capt. R. GAMBIER-PANY ... The Old Toll House, Broxbourne, Herts.
- 2 DW
- 2 DX W. KENNETH ALFORD ... Rosedene, Camberley, Surrey.
- 2 DY F. H. HAYNES ... 38, Sittingbourne Avenue, Enfield, Middlesex.
- 2 DZ F. H. HAYNES ... 38, Sittigbourne Avenue, Enfield, Middlesex.

### 2 F

- 2 FA F. G. H. BENNETT ... 16, Tivoli Road, Crouch End, N. P.
- 2 FB WILLIAM ISON, A.M.I.R.E. Avonview, Harmham, Salisbury, Wilts.
- 2 FC
- 2 FD
- 2 FE
- 2 FF
- 2 FG LESLIE McMICHAEL, F.R.S.A. Everest, Princes Park Avenue, Golders Green, N.W. 3.
- 2 FH
- 2 FI
- 2 FJ W. J. FRY ... 22, Thirsk Road, Lavender Hill, S.W. 11.
- 2 FK F. C. GROVER ... 20, Rutland Road, Ilford, Essex.
- 2 FL L. CLAUDE WILLCOX ... Warmminster, Wilts.
- 2 FM Capt. F. C. McMURRAY } 38, Galpins Road, Thornton Heath, Surrey.
- 2 FN
- 2 FO
- 2 FP
- 2 FQ
- 2 FR S. RUDEFORTH ... 54, Worthing Street, Hull, Yorks.
- 2 FS
- 2 FT J. E. WELLS ... 186, Noel Street, Nottingham.
- 2 FU E. T. MANLEY, JUNR. ... 49A, Arthur Road, Wimbledon Park, S.W. 19.
- 2 FV
- 2 FW
- 2 FX H. C. BINDEN ... 32, Oxford Road, Bournemouth.
- 2 FY
- 2 FZ THE RADIO EXPERIMENTAL SOCIETY OF MANCHESTER Reports of reception to E. Butterworth, Esq., B.Sc., 103, Grenville Street, Stockport.





# FIXED CONDENSERS & GRID LEAKS

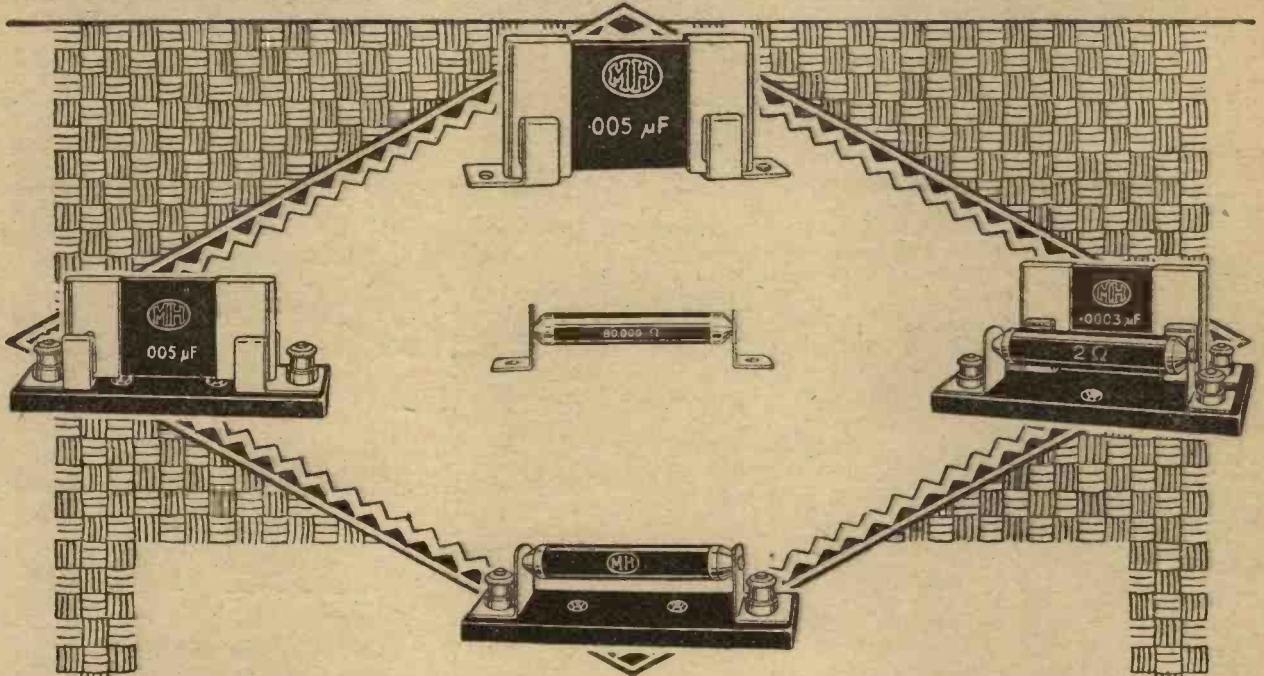

EACH of the components which go to make up a radio circuit must be of the utmost efficiency if perfect results are to be achieved. Especially so in the case of Fixed Condensers and Grid Leaks. The efficiency of the circuit may well depend upon your wise choice of these components. Choose **MH** and you choose fixed condensers and grid leaks to ensure the perfect results which are your ideal.

**MH MICA FIXED CONDENSERS.**

The flat type fixed Condenser was introduced and adopted as the **MH** standard. They slip into two clips and are robust and reliable.

**PRICES (in Cartons). Any value.**

0.0001 μF to 0.001 μF	.. .. (030)	1/9 each
0.015 μF to 0.01 μF	.. .. (031)	2/3 each
0.015 μF to 0.03 μF	.. .. (034)	2/6 each

(Two clips are supplied with each condenser.)  
 to be mounted on ebonite base, with terminals, any value,  
 1/- extra.

**MH GRID LEAKS.**

The construction of the **MH** Standard Type Leak or resistance embodies the use of a special constant resistance compound which is completely sealed into an ebonite tube by metal contact ends. The unit slips between two spring clips.

**PRICES (in Cartons).**

Grid Leak, all values	.. .. (040)	2/- each
Anode resistance, all values	.. .. (041)	2/6 each

(Each supplied with two clips.)  
 Mounted on ebonite base with terminals.

Grid Leak, all values	.. .. (040)	3/- each
Anode resistance, all values	.. .. (043)	3/8 each

**MH GRID LEAK AND CONDENSER.**

An extremely useful and efficient unit, containing a 0.0003 μF Condenser and 2 Mfd. Grid Leak mounted on ebonite base with terminals

Price (020) ... .. 4/- each.

VISIT THE **MH**  
 STAND No. 6 AT THE  
 N.A.R.M.A.T.  
 EXHIBITION.

ROYAL ALBERT  
 HALL  
 SEPT. 12TH TO  
 SEPT. 23RD, 1925

Works:—  
 WEXHAM ROAD, SLOUGH  
 Phone: SLOUGH 199

**L.M. MICHAEL LTD**

Manufacturers of Wireless and Scientific Apparatus

Head Office:— HASTINGS HOUSE, NORFOLK STREET, STRAND, LONDON  
 TELEGRAPHIC ADDRESS: RADIETHER, ESTRAND, LONDON

London Showrooms:—  
 179, STRAND, W.C. 2.  
 Phone: CENTRAL 6988

Phone: CENTRAL 8272/3  
 CABLE ADDRESS: RADIETHER, LONDON.



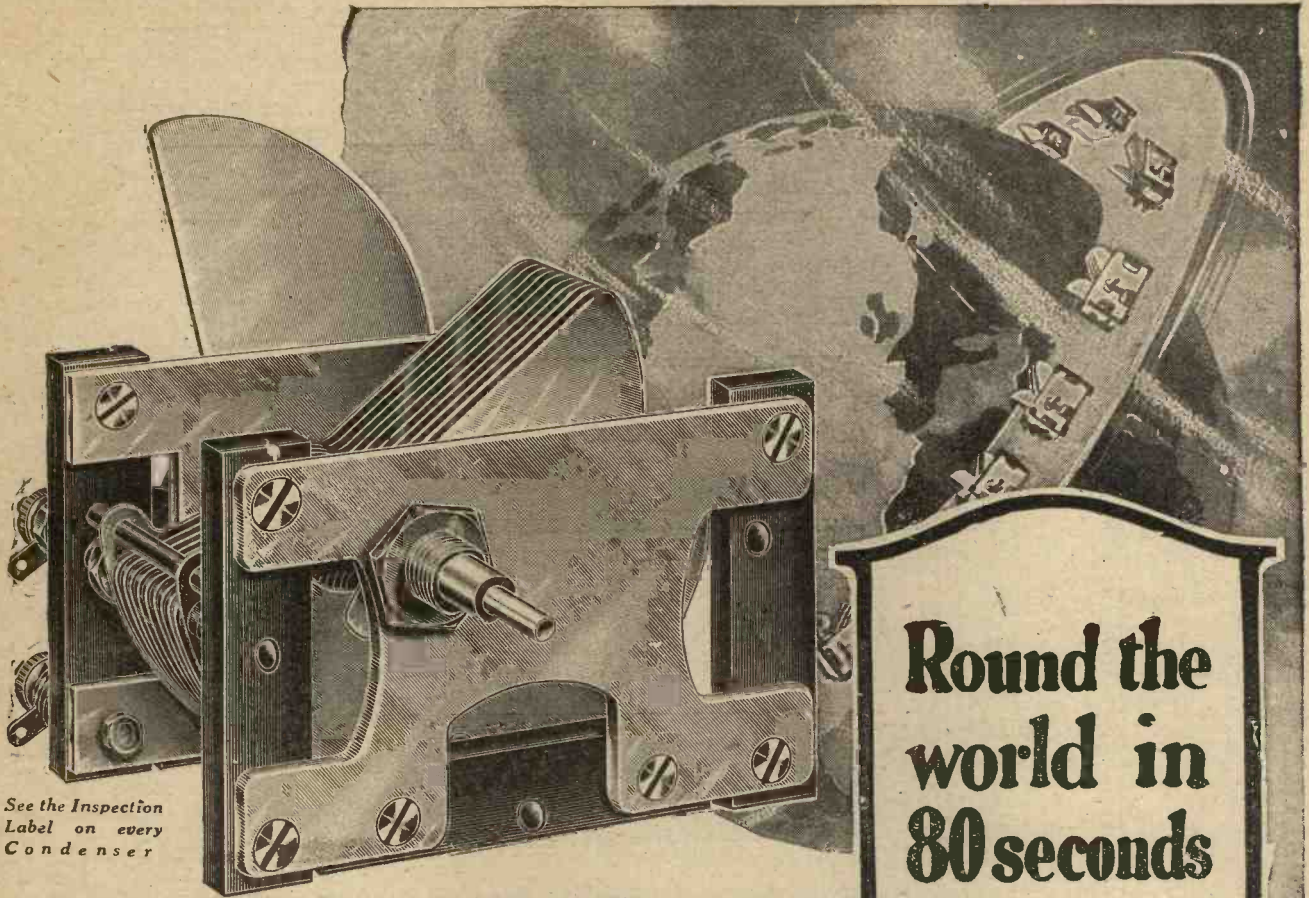

See the Inspection Label on every Condenser

# Ormond Low Loss Condenser

## SQUARE LAW

A new departure in British Condenser design, giving the following advantages:—

1. Practically negligible losses.
2. One-hole fixing—one  $\frac{3}{8}$ " diam. hole is needed to fix this condenser to panel.
3. Rigid construction—cannot warp; end plates of stout aluminium, perfectly flat.
4. Fixed vanes supported by  $\frac{1}{4}$ " ebonite strips.
5. Smooth action, spindle tension is maintained by a specially designed friction washer.
6. Moving vanes and end plates are at earth potential.
7. One-piece knob and dial—supplied loose. Secured by 4BA Set Screw.

This condenser is fitted with optional soldering Tags, or Terminals, and can be supplied with or without Vernier as desired.

Write for our new (1925) Catalogue and Trade Terms.

Supplied in the following sizes:

Size	Price with Vernier	Price without Vernier
00025	8/-	6/6
0003	9/-	7/6
0005	9/6	8/-
001	10/6	9/-

Complete with Knob and Dial.

A

All Cheques and Postal Orders should be crossed and made payable to "The Ormond Engineering Co."

We specialise in turning Brass and Steel Screws and Machined Parts and Accessories of all descriptions.



199-205, Pentonville Road, King's Cross, London, N.1.

Telephone—Clerkenwell 344, 5 & 6.

Telegrams—"Ormondngi, Kinross."

Factory—Whiskin Street, Clerkenwell, E.C.1.

25 YEARS' BRITISH MANUFACTURING EXPERIENCE.

# Round the world in 80 seconds

No man ever looked into the future more accurately than Jules Verne. Yet even he did not foresee the day, now with us, when amateurs can tune in to stations all round the world with a speed that reduces the trip from 80 days to nearer 80 seconds.

The scientific achievements of to-day are possible owing to the genius of modern invention and engineering craftsmanship.

Notable examples are provided by Ormond Products, the outcome of 25 years' British Manufacturing Experience.



2 G

- 2 GA
- 2 GB
- 2 GC
- 2 GD J. C. ELMER ... .. Æthelmar Seabrook Road, Hythe, Kent.
- 2 GE
- 2 GF J. U. NEWSON ... .. 139, Ormside Street, S.E. 15.
- 2 GG
- 2 GH
- 2 GI
- 2 GJ
- 2 GK
- 2 GL
- 2 GM
- 2 GN
- 2 GO
- 2 GP WILFRED GARTLAND ... 14, Baalbeck Road, Highbury, N. 5.
- 2GQ 1ST TAUNTON (WILTON) SCOUTS Headquarters, Wilton, Taunton Station.
- 2 GQ 1ST TAUNTON (WILTON) SCOUTS 11, Park Street, Taunton (Correspondence).
- 2 GR THOMAS FORSYTH ... .. Wenslea, Ashington, Northumberland.
- 2 GS THOMAS FORSYTH ... .. Wenslea, Ashington, Northumberland (Portable set).
- 2 GT GILBERT IRVINE ... .. 11, Park Street, Liverpool.
- 2 GU
- 2 GV Rev. W. P. RIGBY ... .. St. Lawrence Vicarage, Bristol.
- 2 GW J. A. CASH ... .. Föxley Mount, Lymm, Cheshire.
- 2 GX
- 2 GY F. COLSTON HARDWELL ... 91A, Temple Street, Bristol.
- 2 GZ

2 H

- 2 HA
- 2 HB L. H. LOMAS ... .. Highfield, Somerset, nr. Manchester.
- 2 HC FRANCIS M. J. WHITE, B.Sc. Bucklebury, Manor, Berks.
- 2 HD PRESTWICH & DISTRICT RADIO SOCIETY (Hon. Sec., H. A. Wood) Spring Bank, Church End, Prestwich, nr. Manchester.
- 2 HE
- 2 HF W. G. GOLD ... .. Koyama, Lichfield Road, Sutton Coldfield, nr. Birmingham.
- 2 HG THOMAS BOUTLAND ... .. 25, First Row, Ashington, Northumberland.
- 2 HH THOMAS BOUTLAND, JUNR. ... 57, Seventh Row, Ashington, Northumberland.
- 2 HI
- 2 HJ
- 2 HK A. A. CAMPBELL SWINTON, F.R.S. 66, Victoria Street, S.W. 1.
- 2 HL A. A. CAMPBELL SWINTON, F.R.S. 40, Chester Square, S.W. 1.
- 2 HM
- 2 HN
- 2 HO
- 2 HP
- 2 HQ Dr. CLAUDE FAWCETT ... .. 11, Leigh Road, Clifton, Bristol.
- 2 HR H. HARTE, M.I.M.E. ... .. 40, Fields Road, Newport, Monmouth.
- 2 HS G. W. HALE ... .. 36, Dagnall Park, South Norwood, S.E. 25.
- 2 HT
- 2 HU
- 2 HV H. BERESFORD ... .. Drayton, Wylde Green, Birmingham.
- 2 HW H. BERESFORD ... .. 2, 3 and 4, Bull Street, Birmingham.
- 2 HX
- 2 HY
- 2 HZ PERCY NORTHEY ... .. 12, Pelham Crescent, S.W. 7.

2 I

- 2 IA L. F. OSTLER ... .. 13, Windsor Terrace, Penarth, Glamorgan.
- 2 IB
- 2 IC Capt. O. S. STILES ... .. Herons Ghyll, South Harrow Middlesex.
- 2 ID ERNEST S. FIRTH ... .. Rosemead, The Lee, Gt. Missenden, Bucks.
- 2 IE
- 2 IF S. W. BLIGH ... .. 1 and 2, North Lane, Canterbury.
- 2 IG
- 2 IH H. HILEY ... .. R. vercrest, Riddlesden, Keighley, Yorks.
- 2 II
- 2 IJ
- 2 IK
- 2 IL H. R. GOODALL ... .. Fernlea, Winchester Road, Bassett, Southampton.
- 2 IM
- 2 IN
- 2 IO
- 2 IP
- 2 IQ
- 2 IR
- 2 IS
- 2 IT
- 2 IU G. A. E. ROBERTS ... .. Twyford, nr. Winchester.
- 2 IV G. R. MARSH ... .. Mallards Close, Twyford, Winchester, Hants.
- 2 IX S. G. TAYLOR ... .. Fressingfield, Littleover, Derby.
- 2 IY
- 2 IZ A. H. MAIDMENT ... .. Sheldrake, Siddons Road, Forest Hill, S.E. 23.

2 J

- 2 JA A. S. ATKINS ... .. St. Malo, Beauchamp Road, Upper Norwood, S.E. 19.
- 2 JB
- 2 JC
- 2 JD
- 2 JE
- 2 JF C. G. WILLIAMS ... .. Moranedd, 86, Rullerton Road, Wallasey, Cheshire.
- 2 JG WILFRED A. SEED ... .. Crigglestone, Wakefield.
- 2 JH
- 2 JI
- 2 JJ ARTHUR W. SKINNER ... .. 370, Old Kent Road, S.E. 1.
- 2 JK PHILIP R. COURSEY... .. Stamford House, Marchmont Road Richmond, Surrey.
- 2 JL
- 2 JM G. G. BLAKE... .. Holmleigh, Onslow Road, Richmond, Surrey.
- 2 JN
- 2 JO
- 2 JP
- 2 JQ
- 2 JR LEICESTERSHIRE MINES RADIO INVESTIGATION COMMITTEE Operated at Desford Colliery, Desford, nr. Leicester.
- 2 JS
- 2 JT
- 2 JU
- 2 JV
- 2 JW
- 2 JX L. L. VIZARD ... .. 46, Brandville Gardens, Barking-side.
- 2 JY
- 2 JZ R. D. SPENCE ... .. Craighead House, Huntley, Aberdeenshire.

2 K

- 2 KA
- 2 KB W. E. EARP ... .. 675, Moore Road, Mapperley, Nottingham.
- 2 KC
- 2 KD DENISON BROS. ... .. Wireless Engineers, Halifax.
- 2 KE
- 2 KF J. A. PARTRIDGE ... .. 22, Park Road, Colliers Wood, S.W. 19.
- 2 KG Major G. K. FIELD, F.R.S.A., A.M.I.E.E. 19, Edith Villas, W. 14.
- 2 KH W. A. BROOKE ... .. Ashley Wireless Telephone Co., 69, Renshaw Street, Liverpool.
- 2 KI
- 2 KJ
- 2 KK RALPH H. PARKER, F.C.S. ... Radio House, Wilson Road, Smethwick.
- 2 KL F. PINKERTON ... .. 50, Peak Hill, Sydenham, S.E. 26;
- 2 KM C. STAINTON ... .. 155, Estcourt Street, Hull.
- 2 KN
- 2 KO C. S. BAYNTON ... .. 48, Russell Road, Moseley, Birmingham.
- 2 KP F. A. BIRD ... .. 13, Henrietta Road, Bath.
- 2 KQ
- 2 KR E. EDMONDS, JUNR. ... .. 2, Yew Tree Road, Edgbaston, Birmingham.
- 2 KS CHARLES C. BREAKELL ... .. Mill Bank, Church Street, Preston.
- 2 KT J. E. NICKLESS, A.I.E.E. ... .. 83, Wellington Road, Snaresbrook, E. 11.
- 2 KU A. J. SELBY ... .. Edward Street, Burton-on-Trent.
- 2 KV W. J. CRAMPTON ... .. Huntington House, St. George's Hill, Weybridge.
- 2 KW
- 2 KX WALTER STANWORTH ... .. Sherwood, Gorse Road, Blackburn.
- 2 KY I. FOLLARD ... .. 209, Cunliffe Road, Blackpool.
- 2 KZ B. CLAPP, A.M.I.R.E. ... .. Holmville, Warwick Road, Coulsdon, Surrey.

2 L

- 2 LA
- 2 LB ABDUL HAMID GHANI ... .. 7, Mount Ararat Road, Richmond, Surrey.
- 2 LC
- 2 LD R. J. COTTIS ... .. 4, Crondace Road, Parsons Green, S.W. 6.
- 2 LE
- 2 LF
- 2 LG H. H. WHITFIELD ... .. The Glen, Primrose Lane, Hall Green, Birmingham.
- 2 LH
- 2 LI C. H. WILKINSON ... .. 14, Kingswood Avenue, N.W. 6.
- 2 LJ
- 2 LK
- 2 LL
- 2 LM } DR. NOEL S. WALLS ... .. Platt Lane, Hindley, nr. Wigan, Lancs.
- 2 LN }
- 2 LP A. W. KNIGHT ... .. 26, Stanbury Road, Peckham, S.E. 15.
- 2 LQ J. A. HENDERSON ... .. 18, Elm Hall Drive, Mossley Hill, Liverpool.
- 2 LR JOHN SCOTT - TAGGART, F.Inst.P., A.M.I.E.E. Harlow House, 25, Sheldon Avenue Hampstead, N.W.
- 2 LT ARTHUR FREDERICK BARTLE, L.D.S., R.C.S. 3, Coleman Road, Blackheath.
- 2 LU Wm. A. APPLETON, M.B.E., M.I.R.E. Wembley Hill Road, Wembley, Middlesex.
- 2 LV
- 2 LW
- 2 LX
- 2 LY H. H. THOMPSON ... .. 24, Golders Way, Golders Green, N.W. 11.
- 2 LZ F. A. MAYER ... .. Stilemans, Wickford, Essex.



2 M

- 2 MA P. L. SAVAGE ... 14, Norwich Road, Lowestoft, Suffolk.
- 2 MB E. H. JEYNES ... 67, St. Paul's Road, Gloucester.
- 2 MC Lieut. HORACE B. DENT ... Albion, 39, Fleetwood Avenue, Westcliff-on-Sea.
- 2 MD C. CHIPPERFIELD ... Victoria Road, Oulton Broad.
- 2 ME
- 2 MF
- 2 MG
- 2 MH
- 2 MI A. O. MILNE ... Homefleet, Northdown Way, Margate.
- 2 MJ
- 2 MK A. W. HAMBLING, A.M.I.R.E. 80, Brondesbury Road, Brondesbury, N.W. 6.
- 2 ML R. C. CLINKER, M.I.E.E. ... Tryfn, Bilton, Rugby.
- 2 MM CECIL C. C. HINE ... Watley, Twyford, near Win.
- 2 MN
- 2 MO F. O. READ ... 26, Flanders Road, Bedford Park, W. 4.
- 2 MP
- 2 MQ PERCY W. HARRIS, M.I.R.E. 29, South Ridgway Place, Wimbledon, S.W. 19.
- 2 MR
- 2 MS Dr. R. H. REECE ... The Corner House, 62, Addison Gardens, W. 14.
- 2 MT
- 2 MU
- 2 MV
- 2 MW
- 2 MX
- 2 MY H. M. HODGSON ... Clifton House, Hartford, Cheshire, Burfield, Gloucester.
- 2 MZ J. MAYALL, A.M.I.E.E., M.Sc.C.E. (France).

2 N

- 2 NA H. FROST ... Longwood, Barr Common, Walsall.
- 2 NB Capt. N. G. BAGULEY ... 33, Castlegate, Newark, Notts.
- 2 NC
- 2 ND
- 2 NE
- 2 NF GORDON S. WHALE ... Whale's Wireless Works and College, East Parade, Colwyn Bay.
- 2 NG
- 2 NH
- 2 NI R. H. LYNE ... 56, Watling Street, Bexley Heath, Kent.
- 2 NJ
- 2 NK P. PRIEST ... 152, Woodside Road, Lockwood, Huddersfield.
- 2 NL F. J. HUGHES, A.M.I.E.E. ... Ashdene, 129, Wells Road, Bath.
- 2 NM GERALD MARCUSE ... Coombe Dingle, Queens Park, Caterham, Surrey.
- 2 NN General H. PALMER, J.P. ... Ashleigh, Offington Lane, Worthing.
- 2 NO H. K. ADAMS ... Linley, Wellington Road, Walsall.
- 2 NP H. G. TREADWELL ... Middleton, Cheney, nr. Banbury.
- 2 NQ J. W. PALLISTER ... 33, Westbourne Terrace, Stockton-on-Tees.
- 2 NR
- 2 NS MAURICE BURCHILL ... 30, Leighton Road, Southville, Bristol.
- 2 NT
- 2 NU
- 2 NV
- 2 NW H. LITTLE ... Radio Villa, White Hill, Kinver Staffs.
- 2 NX
- 2 NY H. LITTLE ... Radiohm, Lodge Road, West Bromwich.
- 2 NZ

2 O

- 2 OA Capt. E. A. ANSON ... Morton Cottage, Port Seton, East Lothian, Scotland.
- 2 OB
- 2 OC
- 2 OD E. J. SIMMONDS ... Meadowlea, Gerrards' Cross, Bucks.
- 2 OE
- 2 OF H. C. TRENT ... Camden House, Camden Street, Lowestoft.
- 2 OG
- 2 OH
- 2 OI COLIN BAIN ... 140, Northumberland Street, Newcastle-on-Tyne.
- 2 OJ
- 2 OK
- 2 OL H. D. BUTLER ... Trebarurth, South Nutfield, Surrey.
- 2 OM HAROLD S. WALKER, M.I.R.E. Park Lodge, 9, The Butts, Brentford, Middlesex.
- 2 ON Major H. C. PARKER, A.M.I.E.E. 56, Shern-Hall Street, Walthamstow.
- 2 OO Capt. P. P. ECKERSLEY, Chief Eng. B.B.C., Derby House, Hendon.
- 2 OP Capt. G. COURTNEY PRICE ... 2, St. Anne's Villas, Hewlett Road, Cheltenham.
- 2 OQ D. P. BAKER ... Crescent House, Newbridge Crescent, Wolverhampton.
- 2 OR G. P. KENDALL, B.Sc. ... 30, Pepys Road, West Wimbledon, S.W. 20.
- 2 OS
- 2 OT
- 2 OU
- 2 OV

- 2 OW F. W. WOODWARD ... 5, Portland Gardens, Harringay N. 4.
- 2 OX
- 2 OY C. A. HARNWELL ... Denby Dale, nr. Huddersfield.
- 2 OZ JOHN W. NORTON ... Konrad, Salisbury Road, Exmouth, Devon.

2 P

- 2 PA
- 2 PB D. NICHOLSON ... 383, Kennington Road, Lambeth, S.E. 11.
- 2 PC A. G. DAVIES ... Redcot, Park Road, Timperley, Cheshire.
- 2 PD W. HARVEY-MARSTON ... 477, Coventry Road, Birmingham.
- 2 PE
- 2 PF REDVERS B. JEFFERIES ... Lynn Dene, Mount Hill, Kingswood, Bristol.
- 2 PG B. HESKETH ... Wrexham Road, Slough, Bucks.
- 2 PH L. J. DORE ... 139, Lightwood Road, Bearwood, Smethwick, Staffs.
- 2 PI LOUGHBOROUGH COLLEGE ... (Athletic Ground Station), Ashby Road, Loughborough.
- 2 PJ LOUGHBOROUGH COLLEGE RADIO SOCIETY Loughborough, Leicestershire.
- 2 PK
- 2 PL Major L. N. STEPHENS ... Haddon House, Bridport Harbour, Dorset.
- 2 PM
- 2 PN
- 2 PO N. C. HARDMAN ... Mayfield, Cloughfold, nr. Manchester.
- 2 PP J. S. KNIGHT ... Clark's Hill Nursery, Prestwich, Manchester.
- 2 PQ G. E. MORTLEY, SPRAGUE & Co., LTD. Generator Test Station, Nelson Road, Tunbridge Wells, Kent.
- 2 PR A. E. WHITEHEAD ... Hollingwood, King's Ride, Camberley.
- 2 PS J. H. GILL ... 12, Fourth Avenue, Sherwood Rise, Nottingham.
- 2 PT J. JARDINE ... Syntony, Hall Road, West Blundellsands, nr. Liverpool.
- 2 PU CECIL R. W. CHAPMAN ... Nirvana, 44, Chaplin Road, Wembley.
- 2 PV Capt. G. SMITH-CLARKE ... Shenandoah, Gibbet Hill, Kenilworth, Warwick.
- 2 PW J. MATTHEWSON ... 35, Capel Road, Forest Gate, E. 7.
- 2 PX HENRY H. LASSMAN ... 429, Barking Road, E. Ham, E. 6.
- 2 PY H. CARTER-BOWLES ... 51, Gunterstone Road, Barons Court.
- 2 PZ A. E. J. SYMONDS ... 12, Addison Avenue, W. 11.

2 Q

- 2 QA
- 2 QB R. W. BAILEY ... Broadeaves, Fairfield Road, Widnes, Lancs.
- 2 QC
- 2 QD J. AYRES ... 18, Seaforth Avenue, West Barnes Lane, New Malden, Surrey.
- 2 QE
- 2 QF RICHARD F. GORDON ... 5, Lansdowne Square, Weymouth.
- 2 QG J. S. ALDERTON, M.J.Inst. 114, College Road, Moseley, Birmingham.
- 2 QH G. HEWENS ... 42, St. Augustine Avenue, Grimsby Lincs.
- 2 QI Messrs. HURST & LUCAS ... 3, Mayford Road, S.W. 12.
- 2 QJ
- 2 QK
- 2 QL R. J. HIBBERD, F.R.S.A. ... St. Paul's School, Dorking.
- 2 QM L. HOTINE, M.I.R.E. ... 129, York Drive, Glasgow, W. 2.
- 2 QN A. HOBDAV ... Flint House, Northdown Road, Margate.
- 2 QO P. PRITCHARD ... Blenheim House, Broad Street, Hereford.
- 2 QP L. C. GRANT ... Wandsworth House, Heaton, Newcastle-on-Tyne.
- 2 QQ BURDEPT WIRELESS LTD. ... 17, Eliot Vale, Blackheath, S.E.
- 2 QR
- 2 QS STANLEY WARD ... 28, Pendle Road, Streatham, S.W.
- 2 QT C. C. BARNETT ... Orchard Bungalow, Churchdown, nr. Gloucester.
- 2 QU
- 2 QV W. N. LAMBERT ... Breeze Crest, Plane Tree Road, Hale, Cheshire.
- 2 QW
- 2 QX
- 2 QY A. HINDERLICH ... 15, Lyncroft Gardens, N.W. 6.
- 2 QZ BRIAN H. COLQUHOUN ... 3, Eastbrook Road, Elackheath, S.E. 3.

2 R

- 2 RA FREDK. F. WARNER ... Northdene, High Lane, Nr. Stockport.
- 2 RB H. B. GRYLLES ... Leightondene, Willingdon Road, Eastbourne.
- 2 RC
- 2 RD GEORGE W. FAIRALL ... 27, Newbridge Street, Wolverhampton.
- 2 RE
- 2 RF TECHNICAL COLLEGE ... Bradford.
- 2 RG E. W. SCAMMELL ... 20, Primrose Lane, Hall Green, Birmingham.
- 2 RH "Malmains," Copt Elm Road, Charlton Kings, Cheltenham.
- 2 RI
- 2 RJ MAJOR F. S. MORGAN ... East Farleigh, Kent.
- 2 RK
- 2 RL



# A NOTABLE SHORT-WAVE TRANSMISSION

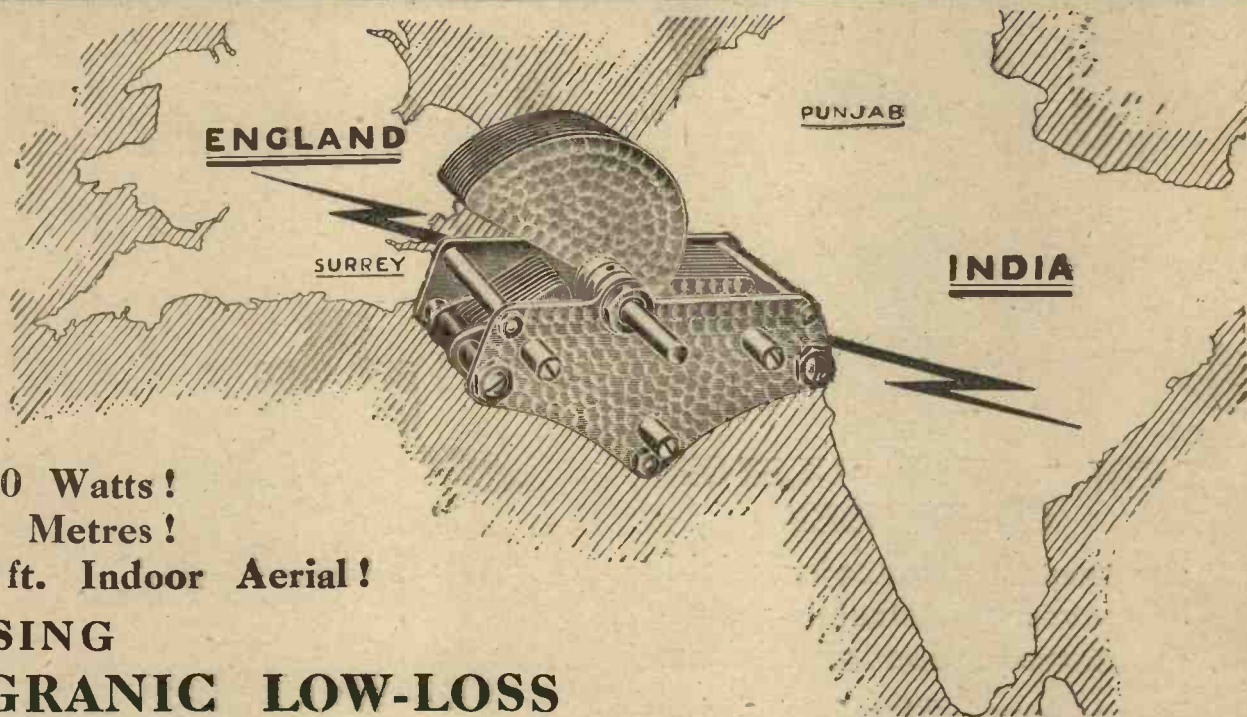

**100 Watts!**  
**45 Metres!**  
**10 ft. Indoor Aerial!**

## USING IGRANIC LOW-LOSS SQUARE LAW VARIABLE CONDENSERS

(Patent No. 220312),

Evidence of the remarkable efficiency and all-round reliability of Igranic Low-Loss Variable Condensers is contained in a letter received by the owner of Experimental Transmitting Station G2DX, of Camberley, Surrey, an extract from which appears below :

G2DX SIALKOT, PUNJAB, INDIA.

8/6/25.

" I herewith report reception of G2DX on 7th June calling SMVI, to whom you gave QRK? Strength of signals 'R7,' note steady but sounded like A.C. W/L about 40 metres (my set is not calibrated). Signals were persistent, not the least sign of fading."

(Sgd.) \_\_\_\_\_

This transmission was accomplished on an indoor aerial 10 ft. long with a power of 100 watts, and the actual wavelength employed was 45 metres. **FOUR STANDARD IGRANIC LOW LOSS VARIABLE CONDENSERS** of .0003 MFD. CAPACITY FORMED PART OF THE TRANSMITTING APPARATUS.

That a "receiving" condenser can contribute to the success of long distance transmission on low power, calling for the utmost efficiency in all parts of the apparatus, is conclusive proof of outstanding superiority in design and manufacture. **USE THEM FOR BOTH RECEPTION AND TRANSMISSION.**

### PRICES

.0003 mfd., 21/-; .0005 mfd. 24/-; .001 mfd., 27/6.

Write for List Z668.

**STOCKED BY ALL REPUTABLE RADIO DEALERS AND FULLY GUARANTEED.**

If at any time you wish to have any information about Igranic Components write to Research Department Z668, Igranic Electric Co., Ltd., Bedford.

IGRANIC RADIO DEVICES include :

Honeycomb Duolateral Coils, Variable Condensers, Fixed Condensers, Filament Rheostats, Intervalve Transformers, Variable Grid-Leaks, Variometers, Vario-couplers, Coil Holders, Potentiometers, Vernier Tuning Devices, Switches, etc., etc.

All carry the IGRANIC guarantee.



LONDON :  
 149, Queen Victoria Street.

BEDFORD :  
 Works : Elstow Road.

MANCHESTER. GLASGOW.  
 LEEDS. BIRMINGHAM.  
 NEWCASTLE. CARDIFF.



# It's here!

## THE NEW "SUPER FULSTOP" CONDENSER

**the greatest advance in variable condenser construction since the introduction of wireless.**

Fifteen months ago the Fulstop Variable Condenser superseded all other condensers. It possessed two entirely new features—it was geared and it abolished absolutely hand capacity effects. The new Super Fulstop Condenser is as far in advance of the old Fulstop as that was in advance of ordinary variable condensers. This is why.

The new Super Fulstop Condenser is fitted with dual gearing. It has two operating knobs. One has a gear ratio of 2 to 1 and is used for first adjustment. The second—a small vernier knob—is geared 125 to 1—and is used for final critical tuning.

The dial is graduated round the whole circumference from 0 to 100. These graduations are again divided, giving 200 actual readings. Each reading is capable of an infinite number of adjustments by means of the vernier gearing.

The clockwork multigear is made by watchmakers for the sake of accuracy and is quite free from backlash.

It is a no-loss condenser, is perfectly square law and has brass vanes.

It is the superlative condenser and is positively unapproached by any other variable condenser made.

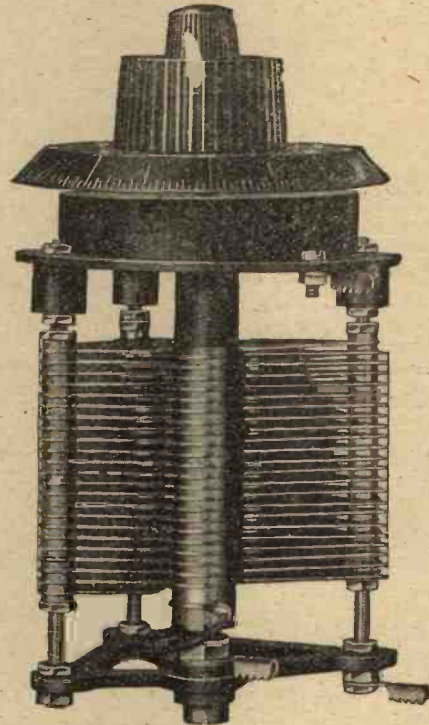

**Guaranteed to Abolish Hand Capacity Effects**

Made in 3 Models.

**SUPER FULSTOP.**

*0025	...	...	...	...	25/6
*0005	...	...	...	...	28/6
*001	...	...	...	...	30/6

*The Standard Fulstop, geared 2 to 1, is still in great demand.*

**PRICES.**

**STANDARD FULSTOP.**

*0002	...	9/6	...	...	...
*0003	...	10/3	...	...	...
*0005	...	11/3	...	...	...
*001	...	13/6	...	...	...

**PLAIN FULSTOP  
(No gears)**

...	...	8/3
...	...	8/0
...	...	9/6
...	...	11/6

*Send for full descriptive leaflet free. There are 3 models and all are guaranteed for 12 months.*

**PROTECTED THROUGHOUT THE WORLD.**

# Fulstop

VARIABLE  
CONDENSER

J. H. NAYLOR, LTD.

WIGAN.



RM S. CROSS ... 3, Norman Road, Heaton Moor, Stockport.  
 2 RJ P. N. LANGHAM ... 102, Wilberforce Road, Leicester.  
 2 RP F. W. EMERSON ... 178, Heaton Moor Road, Heaton Moor, Stockport.  
 2 RQ W. V. WADDUP, B.Sc. ... 56, Wellington Road, Handsworth Wood, Birmingham.  
 2 RR T. HESKETH ... 42, Castle Hill Avenue, Folkestone  
 2 RS THE NORTH EASTERN INSTRUMENT CO. ... Durham Road, Low Fell, Gateshead.  
 2 RU THE NORTH EASTERN INSTRUMENT CO. ... Rowlands Gill, Co. Durham.  
 2 RV  
 2 RW  
 2 RX  
 2 RY D. A. HANLEY ... Forbury, Kintbury, Berks.  
 2 RZ D. T. WOODS ... Denley Villa, Parker Road, Bournemouth.

2 S

SA SIR HANBURY BROWN ... Newlands, Crawley Down, Sussex.  
 SB J. MAYALL, A.M.I.E.E. ... Burfield, Gloucester.  
 SC C. MIDWORTH, A.M.I.E.E. ... Sumia, Ridgeway Road, Osterley, Middlesex.  
 SD  
 SE  
 SF  
 SG F. L. HOGG ... 37, Bishops Road, Highgate, N.6.  
 SH L. C. HOLTON ... 172, Conway Road, Southgate, N.14.  
 SJ WALTER J. BRYCE ... Walpole Street, Preston, Lancs.  
 SK K. GRAHAM STYLES, F.R.A. ... 19, Southampton Buildings, W.C.  
 SL K. GRAHAM STYLES, F.R.A. ... Kitscot, Maidstone, Kent.  
 SM RONALD J. BATES ... 34, Abbeigate Street, Bury St. Edmunds.  
 SN THOMAS GEESON ... Gainsborough House, Congleton Road, Macclesfield.  
 SP L. MANSFIELD ... 27, Rutland Road, Southport.  
 SQ ALFRED J. SPEARS ... Woodlands, Monmouth Road, Warley Woods, Birmingham.  
 SR J. S. SEWELL (Dr.) ... Winter Hey House, Horwich, Nr. Bolton.  
 ST M. ESKDALE ... 330, Manchester Road, Bradford.  
 SU L. V. BRIDGE ... New Hall, Hockley, Essex.  
 SW A. H. FIELDING ... 32, Stanley Avenue, Birkdale, Lancs.  
 SX FRANK B. BAGGS ... 24, Westhorpe Street, Putney, S.W.  
 SY W. H. BROWN ... Mill Hill School, N.W.7.

2 T

TA H. ANDREWES ... 8, North Grove, Highgate, N. 6.  
 TB  
 TC  
 TD  
 TE  
 TF W. WINKLER... 13, Lochharton Crescent, Edinburgh.  
 TG T. F. WALL ... University of Sheffield.  
 TH T. F. WALL ... University of Sheffield (Portable).  
 TI H. BEVAN SWIFT, A.M.I.E.E. ... 49, Kingsmead Road, Tulse Hill, S.W. 2.  
 TJ  
 TK  
 TL B. VIVIAN R. MARTIN ... 128, Dairy House Road, Derby.  
 TM  
 TN CHARLES EDWARD STUART... Lyndon Lodge, Polesworth, Tamworth.  
 TO F. T. G. TOWNSEND ... 46, Grove Lane, Ipswich.  
 TP C. W. ANDREWS ... Radioville, 26, Melody Road, Wandsworth Common, S.W. 18.  
 TQ  
 TR F. O. SPARROW ... 8, North Drive, Swinton, Manchester.  
 TS  
 TT  
 TU W. T. TUCKER ... Parkside, Loughborough, Leicestershire.  
 TV E. W. WOOD... 69, Kettering Road, Northampton.  
 TW E. W. WOOD... Portable Station.  
 TX A. R. C. JOHNSTON ... 87, Twyford Avenue, Acton, W.  
 TY  
 TZ ERNEST JONES ... Newholme, 540, Hempshaw Lane, Offerton, Stockport.

2 U

UA  
 UB A. KENDRICK & Co. ... Automobile & Electrical Engineers, Westbury, Wilts.  
 UC E. J. NOCK WINSTONE ... 53a, Gunterstone Road, West Kensington, W. 14.  
 UD  
 UE  
 UF H. BAILEY ... 51, Manchester Road, Denton, Nr. Manchester.  
 UG W. HUMPHREYS BURTON ... 703, Portland Road, Nottingham.  
 UH W. H. CROSS... 107, Machon Bank, Nether Edge, Sheffield.  
 UI A. R. OGSTON ... 41, Broomfield Avenue, Palmers Green, N. 13.

2 UJ LEONARD R. ROWLANDS ... Mona, Cholmeley Park, Highgate, N. 6.  
 2 UK ARTHUR E. VICK ... Bourville Day Continuation School, The Green, Bourville, Birmingham.  
 2 UL  
 2 UM H. LLOYD, M.Eng. ... 3, Ventnor Place, Sharrow, Sheffield.  
 2 UN  
 2 UO  
 2 UP ARMSTRONG COLLEGE ... Newcastle-on-Tyne.  
 2 UQ  
 2 UR  
 2 US  
 2 UT  
 2 UU  
 2 UV W. E. F. CORSHAM ... 104, Harlesden Gardens, Harlesden, N.W. 10.

2 UW  
 2 UX A. T. HEADLEY ... 104, Grosvenor Road, Harborne, Birmingham.  
 2 UY WILLIAM FENN ... Holly Cottage, Holesworth, Tamworth.  
 2 UZ C. V. STEAD ... 22, Roundhay Mount, Harehills Lane, Leeds.

2 V

VA R. J. SAWBRIDGE, A.M.I.E.E. The Broadfield Radio Co., Ltd., Tenby.  
 VB F. E. HAMMOND ... Shooters Hill, S.E. 18.  
 VC A. S. GOSLING ... 63, North Road, West Bridgford, Nottingham.  
 VD E. L. CROWE... Juniper Pough, Hardres, Canterbury, Kent.  
 VE  
 VF HAROLD A. BLACKWELL ... Whyte House, Bispham, Blackpool.  
 VG F. E. WENGER ... The Brampton, Newcastle, Staffs.  
 VH  
 VI H. CURTIS ... 26, Upper Hall Lane, Walsall.  
 VJ B. J. AXTEN ... 78, Ealing Road, Wembley, Middlesex.  
 VK BURNDIPT WIRELESS, LTD. Aerial Works, Blackheath, S.E.  
 VL  
 VM J. LIPOWSKY ... 614, Old Ford Road, E. 3.  
 VN H. DRURY-LAVIN ... Old House, Sonning, Berks.  
 VO ALAN C. HOLMES ... 60, Aire View, Cononley, Koughley, Yorks.  
 VP P. G. A. H. VOIGT ... 121, Honor Oak Park, S.E. 23.  
 VQ H. B. OLD ... "Park View," St. Jude's Avenue Mapperley, Nottingham.  
 VR F. W. WILSON ... 115, Richmond Road; Montpelier Bristol.  
 VS  
 VT  
 VU J. W. HOBLEY ... The Drive, Wellingborough.  
 VV  
 VW  
 VX  
 VY R. E. V. ELY ... Highlands, Sutton, Surrey.  
 VZ

2 W

WA F. W. J. PIGOTT ... Manor Farm, Wolvercote, Oxford.  
 WB W. BANNISTER ... 62, Knoll Street, Rochdale, Lancs.  
 WC  
 WD C. W. CLARABUT, M.Inst.E.... Beverley Crescent, Bedford.  
 WE  
 WF PROFESSOR A. M. LOW ... The Yews, Woodstock Road, W. 2  
 WG GAMBRILL BROS., LTD. ... Merton Road, Southfields, S.W. 18.  
 WH  
 WI C. J. MUNDAY ... 37, Leat Street, Tiverton, Devon.  
 WJ R. L. ROYLE... Southold, Aldermans Hill, Palmers Green, N. 13.  
 WK  
 WL  
 WM JOSEPH W. PALETT ... 117, Ruby Street, Leicester.  
 WN A. H. WILSON ... 8, Stanley Street, Hanley.  
 WO  
 WP INTERNATIONAL WESTERN ELECTRIC CO., INC. ... Connaught House, Aldwych, W.C2  
 WQ C. H. GARDNER ... Amblecote House, Brierley Hill, Staffs.  
 WR L. W. BURCHAM ... Station: Bibsworth Garage, Bibsworth Road, Finchley, N. 3. Private Address: Valence, Grosvenor Road, Church End, N. 3.  
 WS  
 WT H. CHADWICK ... 9, Raimond Street, Bolton.  
 WU C. H. BAILEY ... Charlacre, Chepstow.  
 WV  
 WW  
 WX  
 WY H. J. SWIFT ... 77, Upper Tulse Hill, S.W. 2.  
 WZ Capt. E. A. HART-HOBSON ... 32, Wilbury Road, Hove, Sussex.

2 X

XA  
 XB  
 XC H. JOHNSON ... Avondale, Chestnut Walk, Worcester.  
 XD H. R. GLADWELL ... London Road, Abridge, Essex.  
 XE  
 XF E. I. CHAPMAN, ASSO.I.R.E. Studland Bay House, Studland, Nr. Swanage.  
 XG A. E. TURVILLE, F.B.O.A.... 108, Abington Street, Northampton.



# Use Bowyer-Lowe Tested For your Year of



## All-British Super-Heterodyne Transformers

Because they are built for use with British Valves, which are more stable than those of foreign makes, these Transformers give increased amplification with absence of background noise. Amateurs who have made the Seven Valve Receiver described in the booklet accompanying each set of Transformers say that its selectivity and purity of reception surpasses any set they have made.

The set of Four Intermediate Frequency Transformers, matched and tested at 500 volts between windings against short circuiting, complete with instructions, costs ...

£4

## Constructor's Kit for Building the Bowyer-Lowe Seven Valve Super-Het.

Containing all Panels, Baseboard. Set of Transformers, Oscillator Coupler, Neutrodyne Condenser, etc.; with full size wiring diagrams and instructions for building a Seven Valve Super Het. ...

£10



## Model II. Oscillator Coupler

A late development of Super-Het. design. Operates on direct coupled system without a pick-up coil. More sensitive than other types of coupler.

Covers range of 260 to 550 metres when tuned with Bowyer-Lowe .0005 Square Law Condenser. Price with wiring diagram and instructions ...

£1

**D**URING the coming winter Wireless Experimenters everywhere will make finer and more perfectly receptive instruments than the past has seen—because the acceptance and use of the Low Loss principle in design will enable them to conserve all the electrical energy which reaches their sets.

Bowyer-Lowe's have been the first English manufacturers to make full use of this principle in the production of Receivers and Components. The parts they make reach a laboratory standard of precision. Experimenters rely on them because they know that every one must pass stringent tests to ensure its efficiency before it reaches their hands.

Use Bowyer-Lowe parts this year and so be sure that all your sets are worthy of the care and thought you put into them.

## Send for Price List of all Bowyer-Lowe Tested Products.

A postcard brings it to you. Within it you will find much valuable help, and all the information you require to choose and order components that will give complete satisfaction.

All good dealers stock Bowyer-Lowe Tested Products, or you may order them direct if you have difficulty in obtaining any you require.

Every product is fully guaranteed and dealers have authority to exchange any which do not give the fullest measure of service.

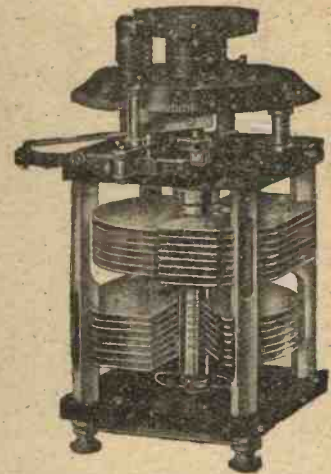

## The Invention of the Year

Four low loss, ball-bearing, Square Law Condensers in one; with solid brass plates jigsoldered to solid brass standards; that is the Bowyer-Lowe Four Square, the most remarkable condenser ever made.

It has no spacing washers. Its plates will not break or bend if it is accidentally dropped. So superb is the electrical design that it will oscillate on wavelengths well below 20 metres. Each condenser has three single capacities and one double capacity, any one of which may be used at will. The control of this condenser is so sensitive that adjustments of almost vernier accuracy can be obtained with finger and thumb. Write for information leaflet about this remarkable instrument.

## The Bowyer-Lowe FOUR SQUARE Square Law Condenser



## Its Micrometer Attachment

is the most sensitive tuning device in modern practice. It moves all the Four Square Condenser varies through five degrees on a gear reduction of 33 to 1. With it, tuning of the most sensitive kind is simply and efficiently obtained.

Fully Descriptive Brochure Free.

**Send for particulars of all these Bowyer-Lowe Tested Products:—**  
**Seven Valve and Super Heterodyne Cabinet Receivers; Four, Three and Two Valve "Vox Populi" Cabinet Receivers; Crystal Receivers; Wavemeters; Wavetraps; Audibility Meters; Square Law Condensers; Coils; Frame Aerials; Precision Buzzers; Switches; Fixed Couplers; and all Components for the Construction of Efficient Receiving Apparatus.**



# Low - Loss Components Great Achievement



### "ANTIPONG" non-microphonic Valve Holder

Low loss, anti-capacity, and shock absorbing, this valve holder prevents all microphonic noises in Dull Emitter Valves and reduces to a minimum Inter-electrode Capacity. Valve Legs, entirely surrounded by air, are attached to phosphor bronze springs, all securely fixed to a Bakelite Ring, which will not melt under the soldering iron. Universal Fitting, with screws for baseboard and panel mounting, ... **3/-**



### Anti-Capacity Valve Holder for Baseboard Mounting

Anti-capacity type, of improved design, this valve-holder is for baseboard mounting. It is also of great use as a holder for H.F. Plug-in Transformers.

Polished Ebonite base. Price complete **2/6**



### Coil Plug and Socket

Three types made; one mounted on a circular Ebonite flange for use on wood panels or cabinets, with connection underneath; another for baseboard mounting with top connection; and a third consisting of a Plug and Socket only, with drilling template for Panel Mounting. Flange type, 2/6; Baseboard type, 2/6; Plug and Socket only (as illustrated), **9d.**



### Bowyer-Lowe Voltmeters

For Panel Mounting. Reasonably priced instruments, specially made for sets employing Dull Emitter Valves, current consumption at 3 volts, .045 amps. The instrument fits in a hole 2 1/4 in. diameter, is beautifully finished, highly polished, and has a clear dial. Price ... **14/-**



### The Bowyer-Lowe Valve Window

Designed to meet the demand for a Valve Window of superior appearance and finish. Made in heavy gauge brass, thoroughly nickel plated and highly polished. Outside diameter, 1 1/2 in.; gauze covered opening 1 in. diameter. Outer and inner circumferences have rounded edges. Supplied complete with back plates, gauze and fixing nuts. Each ... **9d.**



### The Neutrodyne Condenser

Designed for use in Neutrodyne circuits where unusually low capacity is essential, this condenser is also exceedingly valuable as a vernier, in parallel with a larger condenser. So connected, it is of the greatest value in Super-Het. circuits. Made of First Grade Ebonite and Solid Brass. Fitted in panel with single screw and additional 1/8 in. hole for spindle. Price **5/-**



### Bowyer-Lowe MATCHED

### H.F. Transformers

The very fact that every Bowyer-Lowe Transformer can be guaranteed to match every other in its range without special selection is itself good evidence of the great skill and care with which these Transformers are made. They are section wound, with Primary and Secondary loosely coupled. The Primary is tuned with a .0003 variable condenser to cover the stated range. Every condenser is individually tested against standards. All ranges from 550 to 2,000 metres and up are supplied; as well as a special Neutrodyne Unit covering 500 to 600 metres. All **7/-** ranges. Each



### Bowyer-Lowe Ebonite

Guaranteed P.O. Grade A, and sold under seal. May be used with perfect safety without rubbing down. Bowyer-Lowe Panel Service enables every amateur to obtain accurately drilled and engraved panels for any set for which full-sized blueprints are available. Semi-matt, 1/4 in. thick, cut to any size sq. inch ... **3d.** Hand polished one side and all edges, sq. inch. ... **1d.** Drilled, engraved and polished, sq. inch ... **1 1/2d.**



### Anti-Capacity Valve Holders

Built for fitting to panels without screws or nuts. Ebonite base plate is tapped.

Price complete. **1/2**



### Variometers

With ebonite formers and damp proofed windings, Bowyer-Lowe Variometers and Vario-couplers are well known for their first-class design and workmanship. Several types are made, covering most needs of the amateur, and full information concerning them will be sent on application.

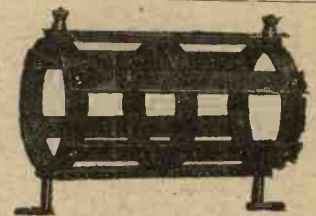

### Low Loss Coil Formers

Skeleton formers should always be used to ensure efficiency, especially on short wavelengths. The series of Low Loss Formers made by Bowyer-Lowe covers most needs of the amateur for both transmission and reception. Prices:

3 1/2 diam. by 6 inches long	5/-
4 1/2 " " 4 " " "	6/-
4 1/2 " " 6 " " "	7/6
4 1/2 " " 8 " " "	8/6
4 1/2 " " 10 " " "	10/-

Full particulars on request.

## Bowyer-Lowe Co., Ltd.,

Makers of Precision Apparatus for Wireless,

Radio Works - - - Letchworth.

N.A.R.M.A.T. Wireless Exhibition,  
**ALBERT HALL, Sept. 12 to 23**

ALL that is best in modern Radio design will be here. Mr. A. E. Bowyer-Lowe and Mr. A. Bowyer-Lowe will be in personal attendance at this stand throughout the run of the Exhibition.



BRITISH THROUGHOUT

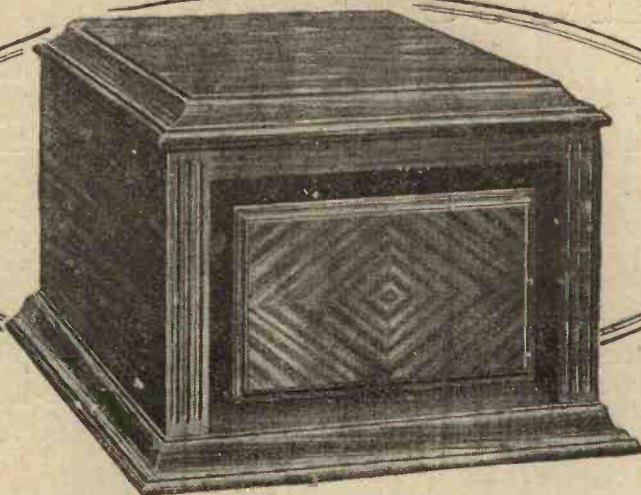

**The New HQ**

A handsome new Loud Speaker possessing the same beauty of outline as the luxurious Q-type whilst retaining the full volume and sensitiveness of the well-known H1. Can be supplied either in a rich brown colour or a glossy black. Polished mahogany base with nickelled fittings. A superb instrument which will charm everyone with its exceptional fidelity of reproduction. Height 20 in 4000 ohms. **£6**  
Also in 120 and 2000 ohms.

**The New H3**

A new Loud Speaker embodying all the well-known Brown features. Although only 15 inches high it gives the same superb tone as the larger H1 and is equally clear on speech and music. No other Loud Speaker on the market within several pounds of its price can give such a fine volume as the H3. **£3**  
In all resistances.

As pleasing to the eye as to the ear  
—this elegant Brown Cabinet Loud Speaker marks a new era in design

It has been left to the manufacturers of the first Wireless Loud Speaker to produce the first British Cabinet Loud Speaker. The handsome Instrument illustrated above is a welcome relief to some of the more usual type of Loud Speakers. Beautifully finished in a rich rosewood shade and made of the best mahogany, it will undoubtedly achieve a very wide measure of popularity.

The same superb volume and purity of tone so characteristic of the Brown will be found in this new Cabinet model. If you have been prejudiced against the use of Loud Speakers—either on account of their appearance or their performance—your last objection has now been removed.

For supreme beauty of outline, clarity of tone and ample volume, the new Brown Cabinet Loud Speaker stands alone. **£6/6/0**  
Supplied in all resistances.

S. G. Brown, Ltd., N. Acton, London, W.3

Showrooms: 19 Mortimer Street, W.1. 15 Moorfields, Liverpool.  
67 High Street, Southampton.

Depots (Wholesale only): 13 Bushy Park, Bristol.  
5 Wilson's Court, Newcastle-on-Tyne.



**The New A-type**

At last we have been able to produce the new Brown A-type headphones at the sensational price of 30/-. The same famous tuned reed movement is used. At such a low price you cannot afford to be without a pair of genuine Brown A-type Headphones—famous throughout the world. **30/-**

Brown Featherweight Headphones sold everywhere at 20/- per pair (4000 ohms resistance).

**Standard Brown Loud Speakers**

H1.	120 ohms	£2 5 0
	2000 ohms	£2 8 0
	4000 ohms	£2 10 0
H2.	120 ohms	£5 5 0
	2000 ohms	£5 8 0
	4000 ohms	£5 10 0
Q type in all resistances		£15 15 0



**The New H4**

We are proud of being able to offer a real Brown Loud Speaker—British throughout, and a replica in every detail of the larger models—at the amazingly low price of 30/-. Small in size but big in performance it is wonderful value for money. 2000 ohms. **30/-**  
Height 10 inches.

**The New Crystavox**

The new and improved horn now fitted to the Crystavox will enable this Loud Speaker to give an exceptional volume of sound direct from a Crystal Set without the use of valves. The powerful Daventry Station will permit thousands of Crystal Set users to get Loud Speaker results direct from a Crystavox. **£6**

**Brown**

HEADPHONES AND LOUD SPEAKERS





2 XH A. E. TURVILLE, F.B.O.A.... 108, Abington Street, Northampton (Portable).  
 2 XI R. H. WAGNER ... .. 6, Maresfield Gardens, N.W. 3.  
 2 XJ  
 2 XK  
 2 XL CAPT. E. S. DAVIS ... .. 12, Hyde Park Place, W.I.  
 2 XM DOWNSIDE WIRELESS SOCIETY Downside School, Stratton-on-the-Fosse.  
 2 XN DOWNSIDE WIRELESS SOCIETY Downside School, Stratton-on-the-Fosse (Portable).  
 2 XO A. TURNER ... .. 13, Elgin Avenue, W. 9.  
 2 XP  
 2 XQ C. F. ELWELL, LTD. ... 138, Gordon Road, Peckham, S.E. 15.  
 2 XR J. F. HAINES ... .. 36, Zetland Street, E. 14.  
 2 XS  
 2 XT  
 2 XU  
 2 XV J. A. JEAPES... .. Chandos, Gt. Shelford, Cambs.  
 2 XW H. A. WOOLYER ... .. 51, Calby Road, West Kirby, Cheshire.  
 2 XX  
 2 XY  
 2 XZ LEWIS T. DIXON ... .. Strathspey, 4, Heythorpe Street, Southfields, S.W. 18.

2 Y

2 YA RICHARD A. MILES, A.M.I.E.E. 4, Cambridge Green, New Eltham, S.E. 9.  
 2 YB  
 2 YC A. KENDRICK ... .. 49, Tasker Street, Walsall.  
 2 YD  
 2 YE  
 2 YF  
 2 YG  
 2 YH GEOFFREY E. DUVEEN ... Broadway, Limpsfield, Surrey.  
 2 YI  
 2 YJ  
 2 YK G. E. DUVEEN ... .. 40, Park Lane, W.  
 2 YL W. H. ALLAN ... .. Scientific Supply Stores, 80, Newington Causeway, S.E.1.  
 2 YM RALPH W. PIPER ... .. Elmhurst, 62, Chiltern View Road, Uxbridge, Middlesex.  
 2 YN A. W. THOMPSON ... .. 32, St. Nicholas Street, Scarborough.  
 2 YO  
 2 YP F. HARRISON ... .. 100, Almond Street, Derby.  
 2 YQ W. P. WILSON, B.Sc., A.C.G.I. The Vicarage, Gipsy Hill, S.E. 19.  
 2 YR ALBERT R. PIKE ... .. 17, Avonwick Road, Heston, Hounslow, Middlesex.  
 2 YS  
 2 YT  
 2 YU G. W. HALE ... .. 36, Dagnall Park, South Norwood, S.E. 25.  
 2 YV G. M. WHILEHOUSE ... All Port House, Cannock, Staffs.  
 2 YW J. H. F. TOWN ... .. 4, Eversley Mount, Halifax.  
 2 YX CAPT. F. E. B. JONES ... 1, Illerest, Birmingham Road, Wylde Green, Birmingham.  
 2 YY  
 2 YZ WESTERN ELECTRIC CO., LTD. North Woolwich.

2 Z

2 ZA  
 2 ZB L. F. ALDOUS ... .. 48, Harpenden Road, West Norwood, S.E. 27.  
 2 ZC  
 2 ZD A. WOODCOCK ... .. 1, Montague Road, Handsworth, Birmingham.  
 2 ZE  
 2 ZF  
 2 ZG W. J. BADMAN ... .. St. Albans, Southside, Weston-Super-Mare.  
 2 ZH  
 2 ZI  
 2 ZJ W. J. BROWN ... .. Eversley, Davenport Park, Stockport.  
 2 ZK W. L. TURNER ... .. Purley, Clady, West Kirby.  
 2 ZL  
 2 ZM  
 2 ZN  
 2 ZO L. H. SOUNDY ... .. 8, Chester Gardens, Argyll Road, Ealing.  
 2 ZP GEORGE F. FORWOOD ... West Chart, Limpsfield, Surrey.  
 2 ZQ H. W. NUNN... .. 49, Leigh Road, Highbury, N. 5.  
 2 ZR MESSRS. S. G. BROWN, LTD. 19, Mortimer Street, W. 1.  
 2 ZS F. J. DINSDALE ... .. 3, Sunnyside, Kendal.  
 2 ZT C. M. BENHAM ... .. Benhilton, Westbury Road, New Malden, Surrey.  
 2 ZU  
 2 ZV F. T. SMITH ... .. Ivy Hall, Panfield, Nr. Braintree, Essex.  
 2 ZW SYDNEY C. PARISH, M.A. ... The Uplands, Lordwood Road, Harborne, Birmingham.  
 2 ZX  
 2 ZZ FELLOWS MAGNETO CO., LTD. Cumberland Avenue, Park Royal, N.W. 10.

5 A

5 AA "LEICESTER MERCURY" ... 25-29, Albion Street, Leicester.  
 5 AB L. W. C. MARTIN ... .. 4, Beer Street, Yeovil, Somerset.  
 5 AC W. G. KIMBER ... .. 39, Bargery Road, Catford, S.E.  
 5 AD  
 5 AE  
 5 AF J. A. H. DEVEY ... .. 232, Gt. Brickkiln Street, Wolverhampton.

5 AG A. E. GREGORY ... .. 77, Khedive Road, Forest Gate, E. 7.  
 5 AH  
 5 AI A. H. SHEFFIELD ... .. 139, Walwood Road, Leytonstone, E. 11.  
 5 AJ W. C. BARRACLOUGH ... 9, Rutland Avenue, Withington, Manchester.  
 5 AK HAROLD GUY MANSELL ... Cleve View, Harvington, Nr. Evesham.  
 5 AL  
 5 AM  
 5 AN  
 5 AO JOHN McLAREN, B.Sc. (Eng., Lon.) Dalriada, Worthing.  
 5 AP  
 5 AQ D. DOUET ... .. 10, Ruvigny Gardens, Putney S.W.  
 5 AR E. DAWSON OSTERMEYER ... 59, Gordon Road, E. 18.  
 5 AS FRED. A. BOURNE ... .. 10, Linley Road, Tottenham, N.17  
 5 AT  
 5 AU W. H. GOODMAN ... .. 94, Addison Road, Holland Park, W. 14.  
 5 AV R. W. HARVEY ... .. 25, Shakespeare Avenue, Portswood, Southampton.  
 5 AW FRANK HOUGH (SOUTHPORT), LTD. 60, Sussex Road, Southport, Lancs.  
 5 AX  
 5 AY  
 5 AZ

5 B

5 BA CAPT. G. F. STEVENS ... Stecarven, Woodlands Park, Dudley, Northumberland.  
 5 BB  
 5 BC  
 5 BD  
 5 BE  
 5 BF  
 5 BG J. B. KAYE ... .. Close Hill, Huddersfield.  
 5 BH ALEXANDER V. SIMPSON, A.M.I.R.E. 28, West Gate, Burnley, Lancs.  
 5 BI  
 5 BJ AUTOVEYORS LIMITED ... 84, Victoria Street, S.W. 1.  
 5 BK W. G. H. BROWN ... .. 52, Winstonian Road, Cheltenham.  
 5 BL ARTHUR E. VICK ... .. 19, Gresham Road, Hall Green, Birmingham.  
 5 BM  
 5 BN  
 5 BO  
 5 BP R. A. WELLS ... .. 59, Compton Road, Winchmore Hill, N. 21.  
 5 BR  
 5 BS  
 5 BT L. V. CLARK ... .. 4, Compton Crescent, Chiswick, W. 4.  
 5 BU J. B. KAYE ... .. London.  
 5 BV  
 5 BW CASTLE RADIO CO. ... .. 161, Westminster Bridge Road, S.E. 1.  
 5 BX  
 5 BY  
 5 BZ

5 C

5 CA N. L. YATES-FISH ... .. Clevelands, 19, Mansfield Road, Reading, Berks.  
 5 CB CAPT. K. HARTFIDGE ... 14, Westbourne Crescent, W. 2.  
 5 CC ALFRED W. YOUNG ... .. Foxcombe Road, Bath.  
 5 CD  
 5 CE  
 5 CF F. G. S. WISE ... .. 12, Crouch End Hill, Crouch End, N. 8.  
 5 CG  
 5 CH  
 5 CI  
 5 CJ JOHN BALDERSTON ... .. 6, Clough Terrace, Barnoldswick, Via Colne.  
 5 CK L. H. PEARSON ... .. Premier House, Thorncliffe Road, Nottingham.  
 5 CL  
 5 CM  
 5 CN  
 5 CO  
 5 CP D. V. L. FELLOWS ... .. View Point, 20, North Common Road, Ealing, W.  
 5 CQ  
 5 CR  
 5 CS G. R. M. GARRATT ... .. 35, Abbey Road, St. John's Wood, N.W. 8.  
 5 CT W. U. TURBERVILLE-CREWE 111, Princes Park Avenue, Golders Green, N.W.  
 5 CU  
 5 CV RONALD J. HARRISON ... Blacklands, Sidney Road, Walton-on-Thames.  
 5 CW C. W. ASHTON ... .. Kensington House, James Street Stoke-on-Trent.  
 5 CX ARTHUR HIGSON ... .. 161, Cotton Tree Lane, Colne, Lancs.  
 5 CY  
 5 CZ

5 D

5 DA G. GORE ... .. 24, Brucegate, Berwick-on-Tweed.  
 5 DB C. H. P. NUTTER, F.R.A. ... 39, Warminster Road, South Norwood Park, S.E. 25.  
 DC W. T. AKED, A.M.I.Mech.E. Ashdell, Victoria Road, Thornton-le-Fylde.  
 5 DD CAPT. M. H. BARNES, ... Akado, Ainsdale, Southport.  
 5 DE



5 DF  
 5 DG C. H. STEPHENSON ... 32, Tettenhall Road, Wolverhampton.  
 5 DH  
 5 DI C. J. MATTHEWS ... Broxhill, Romford, Essex.  
 5 DJ  
 5 DK  
 5 DL  
 5 DM A. N. JACKSON LEY ... Grove House, Albert Grove, Nottingham.  
 5 DN CAPT. L. A. K. HALCOMB ... Southdene, 106, Millhouses Lane, Sheffield.  
 5 DO E. J. WATTS ... Selbourne House, Devizes Road, Salisbury, Wilts.  
 5 DP  
 5 DQ  
 5 DR  
 5 DS ARTHUR W. FITZIAN, M.I.E.E. 51, St. James Road, S.W. 17.  
 5 DT LIEUT. S. C. TUCKER ... Bardemont, Crayford, Kent.  
 5 DU  
 5 DV  
 5 DW  
 5 DX  
 5 DY THE CHELMSFORD RADIO COMPANY 76, Duke Street, Chelmsford, Essex.  
 5 DZ  
 5 F  
 5 FA  
 5 FB  
 5 FC  
 5 FD  
 5 FE  
 5 FF  
 5 FG  
 5 FH LEONARD H. LEE ... 155, Rosefield Road, Smethwick, Staffs.  
 5 FI H. D. WEBB ... 59, Bradford Street, Walsall.  
 5 FJ  
 5 FK  
 5 FL  
 5 FM C. A. CARPENTER ... 5, Lenton Boulevard, Nottingham.  
 5 FN  
 5 FO  
 5 FP  
 5 FQ  
 5 FR J. L. JEFFREE, F.R.A. ... 191, St. James Road, Croydon.  
 5 FS W. A. ANDREWS, B.Sc. ... 1, Balmoral Mansions, St. Andrews Park, Bristol.  
 5 FT H. E. F. TAYLOR ... Felstead School, Essex.  
 5 FU UNIVERSITY COLLEGE ... Nottingham.  
 5 FV  
 5 FW S. I. HOLT ... Aylesbury, 21, Bromley Road, St. Annes.  
 5 FX GENT & CO., LTD. ... Faraday Works, Leicester.  
 5 FY  
 5 FZ THE LINCOLN WIRELESS SOCIETY Municipal Technical School, Lincoln.  
 5 G  
 5 GA  
 5 GB LEONARD HUMPHRIES ... 61, Geraint Street, Princes' Park, Liverpool, S.  
 5 GC  
 5 GD E. COURTENAY BURDETT ... 3, Stockfield Road, Streatham, S.W.  
 5 GE  
 5 GF HARRY STOPHER ... 14, Johnson Terrace, Cricklewood, N.W. 2.  
 5 GG R. H. KIDD ... Marlborough House, Newbury.  
 5 GH  
 5 GI  
 5 GJ JAMES BEVIS ... 4, Somerset Road, Linford Estate, Nr. Stanford le Hope.  
 5 GK  
 5 GL  
 5 GM A. GREENSLADE ... Jelf Road, Brixton, S.W. 2.  
 5 GN GREENSLADE & BROWN ... Lansdowne Road, Clapham, S.W. 8  
 5 GO  
 5 GP  
 5 GQ  
 5 GR  
 5 GS WILLIAM GRIEVE ... Winter Wood, Waltham, Nr. Grimsby.  
 5 GT E. S. DOBSON ... Lorne House, Richmond Place, Ilkley, Yorks.  
 5 GU  
 5 GV L. B. FLAGG & A. H. ARNOLL 40, Springwell Avenue, Harlesden, N.W. 10.  
 5 GW  
 5 GX  
 5 GY G. H. HORWOOD ... St. Helier, 56, Cranston Road, Forest Hill, S.E. 23.  
 5 GZ  
 5 H  
 5 HA R. WATSON ... The Beeches, Streatley, Berks.  
 5 HB HAROLD BROOKS (H.B. RADIO Co.) Milton Works, Chester.  
 5 HC  
 5 HD  
 5 HE  
 5 HF  
 5 HG  
 5 HH  
 5 HI I. JRENCE W. BIRCH ... 30, Limesford Road, Waverley Park, S.E. 15.  
 5 HJ  
 5 HK H. S. BECKETT ... 76, Kendal Road, Hillsboro, Sheffield.  
 5 HL

5 HM J. FITTON ... 27, Milnrow Road, Rochdale, Lancs.  
 5 HN D. R. ETHELLES ... Great Bents, Codsall, nr. Wolverhampton.  
 5 HO  
 5 HP CUNNINGHAM, LTD. ... 169-171, Edgware Road, W. 2.  
 5 HQ E. A. POLLARD ... Spring Bank, Limefield, Blackburn, Lancs.  
 5 HIR  
 5 HS M. SAMUEL ... 16, Blenheim Road, N.W. 8.  
 5 HT  
 5 HU  
 5 HV  
 5 HW NATIONAL PHYSICAL LABORATORY Teddington, Middlesex.  
 5 HX  
 5 HY HONRI BAYNHAM ... Cromwell Hall, East Finchley, N. 2.  
 5 HZ C. A. CARPENTER ... 5, Lenton Boulevard, Nottingham.  
 5 I  
 5 IA  
 5 IB  
 5 IC FRANK E. HARVEY ... Fairmead, Woodford Green, Essex.  
 5 ID P. D. COATES ... 55, Ennismore Street, Burnley, Lancs.  
 5 IE  
 5 IF H. FEATHERSTONE, A.M.I.E.E. 3, Cumberland Gardens, Tunbridge Wells.  
 5 IG J. E. SHELDRIK, B.Sc. ... Third Avenue, Denville, Havant, Hants.  
 5 IH  
 5 II  
 5 IJ  
 5 IK B. L. STEPHENSON ... 12, Sheringham Road, Withington, Manchester.  
 5 IL EDGAR PEPPERELL ... 337, Cowbridge Road, Cardiff  
 5 IM  
 5 IN  
 5 IO  
 5 IP ROBERT H. KNOX ... 25, Bridge Street, Berwick-on-Tweed.  
 5 IQ  
 5 IR P. JOHNSON ... 49, Carson Road, Dulwich, S.E. 21.  
 5 IS  
 5 IT  
 5 IW MARCONI (CHELMSFORD) WIRELESS SOCIETY Marconi Works, Chelmsford.  
 5 IX  
 5 IY J. WYNN ... Solihull, Warwickshire.  
 5 IZ  
 5 J  
 5 JA  
 5 JB D. PRICE-JONES ... Manoravon, Llandilo, S. Wales.  
 5 JC IVOR L. MORRIS ... Cemaes Bay, Anglesey.  
 5 JD FRED. BULMER ... 4, Carlton Terrace, Scarborough  
 5 JE  
 5 JF  
 5 JG R. F. LONGLEY ... 19, Totton Road, Thornton Heath, Surrey.  
 5 JH L. WADDINGTON ... 171, Great Horton Road, Bradford, Yorks.  
 5 JI  
 5 JJ L. D. GOLDIE MORRISON ... Woodville, Arkley, Herts.  
 5 JK I. R. HARPER ... Seafield House, Aberdeen.  
 5 JL  
 5 JM W. WOODS ... 8, Frighton Street, Barrow-in-Furness.  
 5 JN  
 5 JO  
 5 JP  
 5 JQ  
 5 JR W. C. P. HEPWORTH ... Moorings, Dovercourt, Essex.  
 5 JS  
 5 JT  
 5 JU  
 5 JV  
 5 JW  
 5 JX MARCUS G. SCROGGIE, B.Sc. ... 19, St. Mildreds Road, Lee, S.E.  
 5 JY RALPH L. ASPDEN ... 6, Southport Road, Chorley, Lancs.  
 5 JZ  
 5 K  
 5 KA  
 5 KB F. W. COOMBER ... Radio House, Fything, Worcester.  
 5 KC T. DODDSON ... 12, Gilnow Road, Bolton, Lancs.  
 5 KD  
 5 KE  
 5 KF  
 5 KG  
 5 KH  
 5 KI  
 5 KJ  
 5 KK  
 5 KL  
 5 KM L. W. J. SILCOCKS ... 77, St. Albans Road, Redlands Bristol.  
 5 KN E. J. EARNSHAW ... Llantwit, Furze Lane, Purley Surrey.  
 5 KO T. W. HIGGS ... 24, Leazes Terrace, Newcastle-on-Tyne.  
 5 KP  
 5 KQ  
 5 KR  
 5 KS HORACE R. HARBOTTLE, B.Sc. 438, Durnsford Road, Wimbledon Park, S.W.



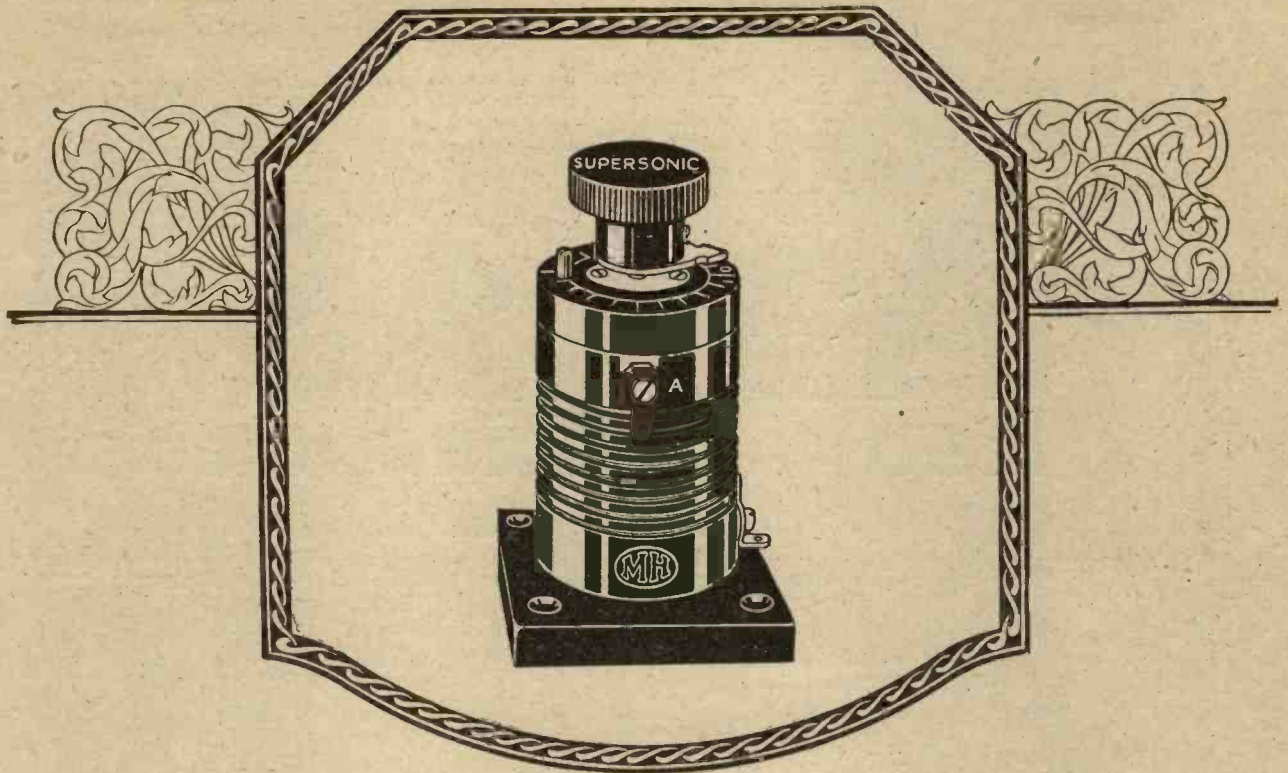

## The **MH** Tuned Supersonic Transformer

WE make no apology for what may appear to many to be the belated appearance of an **MH** Supersonic Transformer.

The long interval elapsing between the first appearance of supersonic transformers on the English market and the **MH** product now issued is the result of our consistent policy to offer nothing to the public but the best.

The unit illustrated is of original design, incorporating a primary condenser (provisionally protected and Patents pending) giving an approximate tuning range of 2,000—3,200 metres, and is fitted with a specially designed and constructed iron core, combining with the advantages given by these, the low self capacity and high electrical efficiency universally recognised as being associated with the **MH** High Frequency Transformers, of which this issue forms part of a consistent series applicable to all H.F. Purposes.

When used in any Supersonic circuit in conjunction with **MH** components, the results obtained are amazing.

**Supersonic (Intermediate or Filter) Transformer with tuning condenser. Base Type (as illustrated) or Plug-in Type (fitted with standard pins) ... 21/- each**

VISIT THE **MH** STAND No. 6 AT THE N.A.R.M.A.T. EXHIBITION, ROYAL ALBERT HALL, SEPT. 12 to 23, 1925.

**OTHER **MH** COMPONENTS OF HIGH EFFICIENCY INCLUDE**

- H.F. Transformers
- Autodyne Units
- Filament Rheostats
- Potentiometers
- Fixed Condensers
- Grid Leaks
- Coil Holders
- Coil Mounts

OBTAINABLE FROM ALL WIRELESS DEALERS

Works :—  
WEXHAM ROAD, SLOUGH  
Phone : SLOUGH 199

**L.M. MICHAEL LTD**

Manufacturers of Wireless and Scientific Apparatus

London Showrooms :—  
179, STRAND, W.C. 2.  
Phone : CENTRAL 6988

Head Office :— HASTINGS HOUSE, NORFOLK STREET, STRAND, LONDON, W.C. 2. Phone: CENTRAL 8272/3  
TELEGRAPHIC ADDRESS: RADIETHER, ESTRAND, LONDON CABLE ADDRESS: RADIETHER, LONDON.

Barclays Ad.

In replying to advertisers, use Order Form enclosed.



# “CLARKE'S ATLAS” Radio Specialities

## PERFECT TUNERS:

1. “Atlas” Aperiodic Coupler (Prov. Pat. No. 15,753).—Definitely cuts out local station and brings in others close in wavelength. Set can be calibrated irrespective of various lengths of aerials. Don't scrap your old coils; simply insert our aperiodic coupler into the core and you have a perfect tuner. Suitable for all wavelengths. Greatly increases the selectivity of your set and is indispensable for eliminating interference.

Price 7/6 each

2. “Atlas” Low-Loss Coils (Patent No. 215,053) embody all that is known of low-loss coil design. The patent twin-wire winding offers a double surface path for H.F. currents. These coils give real meaning to phrases like “Maximum inductance and signal strength,” “Minimum self-capacity,” etc. Unequaled for distance and selectivity.

Prices from 4/3 to 17/6

3. “Atlas” Filament Control (Patent No. 16,427).—Silently efficient, makes economy a pleasure and station-finding easy. Gives absolute and constant control of bright or dull-emitter valves. Soon saves its cost in current alone. Is quite “wire-less”; cannot possibly “pack,” and is good for years of steady service. 50 ohms resistance. One-hole fixing.

Price 6/6 each

4. “Atlas” Fixed Condensers.—Made with strong Bakelite casings. The carefully-selected copper foil and mica sheets are held under pressure by countersunk screws and nuts. All values; constant values. Strong soldering tags are attached and metal parts are heavily nickel-plated. Tested to 1,000 volts prior to dispatch.

Prices from 2/- to 3/-

5. “Atlas” Vernianob (Patent applied for).—Makes ordinary variable condensers into super Vernier Condensers, giving “finest” vernier control. 50 to 1 ratio. Special split bush allows of fitting to condensers having either 3-16th inch or 1/4 inch diameter spindles. Push-pull principle abolished. Fine and coarse movement independent of each other. The station you want can be logged with certainty—a big advantage over separate vane vernier control.

Price 10/9 each

6. “Atlas” Square Law Low-Loss Condensers (Prov. Pat. No. 5030/25).—The lowest of low-loss “square-laws.” The insulation between vanes is outside the electrostatic field, giving lowest dielectric losses. The rotor is ground to the frame, giving freedom from hand-capacity effects. Fitted with “skeleton” end plaques. Zero capacity negligible. Supplied in all usual capacities.

Price from 13/6 to 13/6

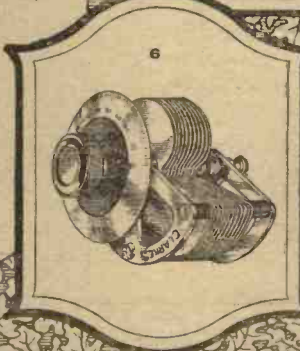

SPECIAL NOTICE.  
Clarke's "Atlas" Low Loss Coils.  
REVISED PRICES.  
Ask your dealer for new list.

Sole Manufacturers:  
**H. CLARKE & CO. (M/cr) Ltd.**  
ATLAS WORKS, OLD TRAFFORD, MANCHESTER.  
Telephone:—683 & 793 Trafford Park.  
Telegrams:—"Pirtoud, Manchester."

We make them good.  
Good judges make them famous.



- 5 KT
- 5 KU
- 5 KV
- 5 KW RENE HODGES ... .. Park Road, Daybrook, Nottingham.
- 5 KX RENE HODGES ... .. Park Road, Daybrook, Nottingham (Portable).
- 5 KY E. G. ALLSOPP ... .. Radio House, Church Street, Tamworth, Staffs.
- 5 KZ R. MITCHELL ... .. Woodstock, High Spring Gardens, Keighley, Yorks.

5 L

- 5 LA
- 5 LB H. C. FOSTER ... .. Hornby Castle, Lancaster.
- 5 LC
- 5 LD
- 5 LE
- 5 LF Major KENYON SECRETAN ... .. 105, Castlenau, Barnes, S.W. 13.
- 5 LG
- 5 LH
- 5 LI
- 5 LJ
- 5 LK J. V. RUSHTON ... .. Craig-y-don Penn, Wolverhampton.
- 5 LM
- 5 LN
- 5 LO J. W. CLOUGH ... .. Holly Hurst, 142, Revidge Road, Blackburn.
- 5 LP L. W. PULLMAN ... .. 213, Golders Green Road, N.W. 11.
- 5 LQ
- 5 LR
- 5 LS A. J. STEVENS, LTD. ... .. 56, Humber Road, Blackheath, S.E. 3.  
Op. R. W. H. BLOXHAM
- 5 LT
- 5 LU
- 5 LV
- 5 LW R. K. DRURY ... .. 7, Salisbury Avenue, Goole.
- 5 LX
- 5 LY
- 5 LZ A. G. S. GWINN ... .. 61, Carnarvon Road, Stratford, E. 15.

5 M

- 5 MA R. MUNDAY ... .. 17, Malden Road, New Malden, Surrey.
- 5 MB W. H. LAMB ... .. 808, Stockport Road, Longsight, Manchester.
- 5 MC
- 5 MD R. W. HARDISTY ... ..
- 5 ME
- 5 MF
- 5 MG MILLIGAN'S WIRELESS CO., LTD. 50, Sauchiehall Street, Glasgow.
- 5 MH
- 5 MI
- 5 MJ
- 5 MK
- 5 ML LEONARD D. HEALEY ... .. 11, Glebe Road, Wallasey, Cheshire.
- 5 MM
- 5 MN
- 5 MO W. G. DIXON ... .. "Dipwood," Rowlands Gill, Newcastle-on-Tyne.
- 5 MP COLIN BAIN ... .. 140, Northumberland Street, Newcastle.
- 5 MQ
- 5 MR N. P. STOATE ... .. 15, Winterstoke Gardens, Mill Hill, N.W. 7.
- 5 MS
- 5 MT
- 5 MU C. W. TITHERINGTON ... .. West Lodge, Moigne, Combe, nr. Dorchester.
- 5 MV
- 5 MW
- 5 MX
- 5 MY
- 5 MZ

5 N

- 5 NA
- 5 NB
- 5 NC
- 5 ND
- 5 NE
- 5 NF ROY W. GALPIN ... .. Chardstock, Mickleburgh Hill, Herne Bay, Kent.
- 5 NH
- 5 NI
- 5 NJ F. R. NEILL ... .. Chesterfield, Whitehead, Co. Antrim, Ireland.
- 5 NK H. COBDIN TURNER, M.I.E.E. 45, Manley Road, Whalley Range, Manchester.
- 5 NL
- 5 NM J. H. D. RINDLEY ... .. Studley, 106, Woodside Green, S. Norwood, S.E. 25.
- 5 NN
- 5 NP ERIC P. BURGESS ... .. 2, Queen's Road, Marningham, Eradford.
- 5 NQ
- 5 NR
- 5 NS
- 5 NT C. H. FRISKNEY ... .. 106, Yarboro' Road, Lincoln.
- 5 NU H. L. THOMSON ... .. 100, Old Fallow Road, Cannock, Stafford.
- 5 NV

- 5 NW E. J. ALLAN ... .. Red Oak, 8, Westfield Place, Dundee.
- 5 NX
- 5 NY
- 5 NZ

5 O

- 5 OA
- 5 OB
- 5 OC
- 5 OD RALPH BATES ... .. Holmside, St. Catherine's, Lincoln.
- 5 OE
- 5 OF W. G. GOLD ... .. Koyana, Lichfield Road, Sutton Coldfield, Birmingham.
- 5 OG
- 5 OH
- 5 OI
- 5 OJ
- 5 OK
- 5 OL JOHN F. CULLEN ... .. 68, Queen's Drive, West Derby, Liverpool.
- 5 OM
- 5 ON
- 5 OO
- 5 OP
- 5 OR
- 5 OS
- 5 OT F. J. WOODS ... .. Belmont, Upper Colwyn Bay, N. Wales.
- 5 OU
- 5 OV C. H. F. HUBBARD ... .. 196, Putney Bridge Road, S.W. 15 (Portable).
- 5 OW E. C. CHIDWICK ... .. 46, Alconbury Road, Clapton, E. 5.
- 5 OX C. H. F. HUBBARD ... .. 196, Putney Bridge Road, S.W. 15.
- 5 OY BELVEDERE, ERITH & DISTRICT RADIO SOCIETY 85, Hengist Road, Erith.
- 5 OZ

5 P

- 5 PA
- 5 PB
- 5 PC
- 5 PD F. A. DURRANT ... .. 366, Forest Road, Walthamstow, E. 17.
- 5 PE
- 5 PF
- 5 PG
- 5 PH
- 5 PI
- 5 PJ A. SHAW ... .. 8, Hall Road, Trawden, nr. Colne, Lancs.
- 5 PK
- 5 PL
- 5 PM
- 5 PN V. H. PENFOLD ... .. 199, Melrose Avenue, Cricklewood, N.W. 2.
- 5 PO
- 5 PP W. S. PLYMOUTH-PERKINS ... .. Levuka, Cumberland Road, Harrow.
- 5 PQ
- 5 PR C. RATCLIFFE ... .. 68A, Dewsbury Road, Leeds, Yorkshire.
- 5 PS
- 5 PT
- 5 PU THEODORE ALLISON ... .. 33, Wilton Grove, Wimbledon, S.W. 19.
- 5 PV
- 5 PW
- 5 PX DEREK SHANNON ... .. Wyvern Grange, Sutton Coldfield, Birmingham.
- 5 PZ G. F. GREGORY, A.M.I.E.E. ... .. 3, Castle View Gardens, Ilford.

5 Q

- 5 QA
- 5 QB
- 5 QC H. C. BATEMAN ... .. 2, Gideon Road, S.W. 11.
- 5 QD
- 5 QE
- 5 QF
- 5 QG
- 5 QH
- 5 QI SOUTH SHIELDS & DISTRICT RADIO CLUB
- 5 QJ SOUTHEND & DISTRICT RADIO SOCIETY Hon. Sec., F. Waller, Eastwood House, Rochford, Essex.
- 5 QK
- 5 QL V. R. MILLS ... .. 122, Hughenden Road, Hastings.
- 5 QM
- 5 QN
- 5 QO
- 5 QP
- 5 QQ H. C. GOODING ... .. 20, Ipswich Street, Stowmarket.
- 5 QR DAVID G. BIRD ... .. 8, Osborne Terrace, South Shields.
- 5 QS
- 5 QT
- 5 QU L. J. DOLPHIN ... .. 229, Hole Lane, Northfields, Birmingham.
- 5 QV F. L. STOLLERY ... .. Fairmead, Vista Road, Clacton-on-Sea.
- 5 QW
- 5 QX J. W. HOLT ... .. 6, Raby Road, New Malden, Surrey.
- 5 QY
- 5 QZ F. CRAWFORD ... .. 34, Leasowe Road, Wallasey, Cheshire.



5 R

- 5 RA HARRIE KING, F.R.A., 2, Dulwich Road, E. Dulwich, S.E. 22.
- 5 RB A. GARNETT ... Bonair, Camberley, Surrey.
- 5 RC W. BRIERLEY, A.M.I.Mech.E. 59, Gayner Park, Filton, Bristol.
- 5 RD
- 5 RE
- 5 RF LEONARD F. HUNTER ... 18, Fannsfeld Road, Sydenham, S.E. 26.
- 5 RG
- 5 RH
- 5 RI A. J. STEVENS & Co. (1914), Wireless Branch, Wolverhampton, LTD.
- 5 RJ
- 5 RK
- 5 RL
- 5 RM
- 5 RN
- 5 RO
- 5 RP CAPT. H. I. HUGHES, HUGHES Engineers, Birkenhead. & WATTS, LTD.
- 5 RQ GILBERT W. TONKIN ... 164, Coldharbour Road, Westbury Park, Bristol.
- 5 RS
- 5 RT C. HAMILTON... 4, Arnold Crescent, Arnold Street, Hull, Yorks.
- 5 RU
- 5 RV
- 5 RW J. W. ELLIOTT ... 69, Castleton Road, Goodmayes, Essex.
- 5 RX
- 5 RY
- 5 RZ A. G. WOOD ... 93, Upper Tulse Hill, S.W. 2.

5 S

- 5 SA
- 5 SB
- 5 SD
- 5 SE
- 5 SF JAMES K. WILKIE ... Avondale, Knowsley Road, Cressington Park, Liverpool.
- 5 SG
- 5 SH
- 5 SI C. L. NAYLOR ... 43, Hill Crescent, Longden Road, Shrewsbury.
- 5 SJ
- 5 SK
- 5 SL
- 5 SM
- 5 SN
- 5 SO
- 5 SP
- 5 SQ
- 5 SR
- 5 SS
- 5 ST CAPT. IAN FRASER, ... St. John's Lodge, Inner Circle, Regent's Park, N.W.
- 5 SV
- 5 SW
- 5 SY
- 5 SZ J. W. RIDDIOUGH ... White Croft, Bare Lane, Morecambe, Lancs.

5 T

- 5 TA VERNON I. N. WILLIAMS, "Merok," Lees Road, Bramhall, M.I.Mech.E., Cheshire.
- 5 TB
- 5 TC
- 5 TD
- 5 TE
- 5 TF PERCY A. GOODING ... 16, Cambridge Road, Hammersmith, W.
- 5 TG
- 5 TH S. H. SUTHERS ... 1, Stamford Brook Gardens, W. 6.
- 5 TI J. BONNETT ... 159A, Turners Hill, Cheshunt, Herts.
- 5 TJ
- 5 TK
- 5 TL
- 5 TM
- 5 TN Capt. C. E. STEWART ... Mount Pleasant, Weymouth.
- 5 TO
- 5 TP
- 5 TQ HARRY RAYNER ... 32, Grange Road, Cleckheaton.
- 5 TR
- 5 TS WALTER DEAN ... Bankleigh, Rainsgreave, Blackburn.
- 5 TT
- 5 TU J. LEITCH RODGER, B.Sc., Woodside, Western Terrace, Falmouth, A.M.I.E.E.
- 5 TV Lieut. W. H. LLOYD, M.C., 27, Copthall Gardens, Twickenham, F.R.S.A.
- 5 TW
- 5 TX
- 5 TY
- 5 TZ W. G. SHERRATT ... 11, Bath Road, Cowes, Isle of Wight.

5 U

- 5 UA
- 5 UB

- 5 UC JACK GARDENER ... 15, Lewis Road, Sutton, Surrey.
- 5 UD
- 5 UE
- 5 UF
- 5 UG
- 5 UH
- 5 UI
- 5 UJ
- 5 UK
- 5 UL J. W. COVENEY ... "Bonita," 30, Arundal Gardens, Goodmayes.
- 5 UM
- 5 UN
- 5 UO RICHARD C. SIMMONDS ... 61, Brightfield Road, Lee, S.E. 12.
- 5 UP
- 5 UQ J. C. LLOYD EDWARDS ... Trevor Hall, Trevor, Wrexham.
- 5 UR
- 5 US JAMES CROYSDALE ... 40A, The Grove, Ilkley, Yorkshire.
- 5 UT
- 5 UU
- 5 UV L. A. JEFFREY ... 90, Harringay Road, Green Lanes, N. 15.
- 5 UW
- 5 UX HERBERT STEPHENSON ... The Bottoms, Gildersome, Leeds.
- 5 UY D. B. FRY ... The Laurels, Mayfield, Sussex.
- 5 UZ J. LLEWELLYN ... Elmfield, 8, Baldrock Road, Letchworth, Herts.

5 V

- 5 VA
- 5 VB G. C. CURTIS ... 33, Swindon Road, Edgbaston, Birmingham.
- 5 VC H. LANGSTAFF ... Commercial Bank Buildings, Bradford, Yorkshire.
- 5 VD P. J. WAKEFIELD ... 31, Station Road, Church End, Finchley, N. 3.
- 5 VE
- 5 VF
- 5 VG
- 5 VH
- 5 VI
- 5 VJ
- 5 VK BERNARD CALDWELL ... Ivy House, Whitley, nr. Northwich, Cheshire.
- 5 VL R. W. LEADER ... Porth, St. Columb Minor, Cornwall.
- 5 VM
- 5 VN
- 5 VO
- 5 VP
- 5 VQ
- 5 VR
- 5 VS
- 5 VT GILBERT C. WEBB ... 10, Osborne Road, Stroud Green, N. 4.
- 5 VU STEPHEN W. BUTTERS ... 51, Clarendon Road, West Croydon, Surrey.
- 5 VV S. A. RICHARDS ... 103, Isledon Road, Finsbury Park, N. 7.
- 5 VW W. V. HARRINGTON ... 72, Bedford Road, Forest Road, Walthamstow, E. 17.
- 5 VX
- 5 VY
- 5 VZ

5 W

- 5 WB
- 5 WC
- 5 WD KENNETH ULLYETT ... "Zennor," Whipps Cross, Leytonstone, Essex.
- 5 WE
- 5 WF DALLAS G. BOWER ... 10, Ventnor Villas, Hove BO., Brighton.
- 5 WG G. M. JONES ... 49, Baron Road, Chadwell Heath, Essex.
- 5 WH A. I. GOODWIN ... 57, Hale Lane, Mill Hill, N.W. 7.
- 5 WI R. E. L. BLANCHARD ... Mayville, Culliford Road, Dorchester, Dorset.
- 5 WJ
- 5 WK
- 5 WL
- 5 WM J. B. RENSHAW ... 17, Walter Street, Audley, Blackburn.
- 5 WN A. T. K. MOIS, A.M.I.E.E. ... 46, Wisteria Road, Lewisham, S.E.
- 5 WO
- 5 WP F. A. WOOLDRIDGE ... 83, Selsey Road, Edgbaston, Birmingham.
- 5 WQ J. R. WITTY ... 44, Cambridge Road, Great Crosby, Liverpool.
- 5 WR
- 5 WS WOOLWICH RADIO SOCIETY Y.M.C.A., Thomas Street, Woolwich (Reports to A. G. Beeson, 12, Court Yard, Eltham, S.E. 9.) (Fixed Station)
- 5 WT
- 5 WU
- 5 WV
- 5 WW
- 5 WX
- 5 WY FRANCIS J. WOOLFENDER ... 68, New Road, Dearnley, Littleboro, Lancs.
- 5 WZ E. W. HETTIGI ... 1, King Street, St. Helier, Jersey, C.I.



# Louden Valves

TRY THE

## DULL EMITTER

whilst our special offer remains open.

For another fourteen days the prices of the Louden Dull Emitters will still be

**8/- and 9/-**

This is your opportunity. You can now satisfy yourself as to the undoubted qualities of Dull Emitters in general and Louden Dull Emitters in particular without incurring any great expense. For another fourteen days the prices of the Louden Dull Emitters will still be 8s. for the 4-volt and 9s. for the 6-volt. Their cost, therefore, is the same, or at the most a shilling more than the cost of the average bright emitter of competitive make.

The Louden 4-volt and 6-volt Dull Emitters consume only 0.1 amperes in the filament. This is approximately one seventh of the current consumed by most bright emitters of other makes.

If instead of these ordinary bright emitters you use Louden Dull Emitters in your set, your accumulator bills will be reduced to one seventh. This will effect a considerable saving in a year's broadcasting expenditure, especially if you possess a multi-valve receiver. An added advantage is that you can substitute Louden Dull Emitters for your Bright Emitters straight away, and without having to make any alterations or additions at all to your filament resistances or set. It is also possible to use this valve in conjunction with a bright emitter, e.g., a bright emitter in the detector stage, and a Dull Emitter Louden in the L.F. position or vice versa.

The 4-volt valve normally costs 12s. and the 6-volt 13s. 6d. For fourteen days, however, we are making the wonderful offer detailed below, so that every member of the wireless public can have the opportunity of testing this valve for himself at a specially reduced figure.

*This offer lasts only for fourteen days.*

### OUR OFFER

Send direct to us at Park Royal, Willesden, a remittance of 8s. for each 4-volt or 9s. for each 6-volt Dull Emitter that you require, plus 3d. postage for each valve. We will then forward you the valves requested in sealed cartons and bearing the usual guarantee. Fill in the coupon below in block letters and tear off.

To The Fellows Magneto Co., Ltd.,  
Cumberland Avenue,

Park Royal, Willesden, N.W.10.

Herewith Remittance Value..... Please send me..... Louden Dull Emitter Valve(s)  
for 4-volt/6-volt\* Accumulators, on conditions as per your advertisement.

Name .....

Address.....

\*Delete whichever does not apply.

M.W. 1/9/25.

***This coupon is not available after September 15.***



5 X

- 5 XA
- 5 XB
- 5 XC
- 5 XD
- 5 XE
- 5 XF
- 5 XG
- 5 XH
- 5 XI
- 5 XJ
- 5 XK
- 5 XL
- 5 XM F. EUSTANCE ... .. 92, Briardal's Road, Moosley Hill, Liverpool.
- 5 XN H. W. EVERITT ... .. 30, Gourock Road, Eltham, S.E. 9.
- 5 XO Capt. L. A. BRATT ... .. Marriott Road, Barnet.
- 5 XP G. H. STANCER ... .. 9, Mark Street, Rochdale.
- 5 XQ
- 5 XR
- 5 XS
- 5 XT P. B. THOMPSON ... .. 17, Fyfield Road, Enfield, Middlesex.
- 5 XU THOMAS N. LORD ... .. 6, Trafalgar Terrace, West Park Street, Dewsbury, Yorkshire.
- 5 XV
- 5 XW
- 5 XY J. C. HARRISON ... .. Highcroft, Park Lane, Burnley, Lancashire.
- 5 XZ

5 Y

- 5 YA
- 5 YB
- 5 YC
- 5 YD E. R. BRIDGWATER ... .. 75, Upper Normacot Road, Longton, Staffs.
- 5 YE
- 5 YF
- 5 YG
- 5 YH
- 5 YI A. L. GOODLIFFE ... .. 17, Malvern Road, Nottingham.
- 5 YJ
- 5 YK G. W. THOMAS ... .. 160, Hills Road, Cambridge.
- 5 YL B. HESKETH ... .. Windy Corner, Kingston, nr. Littlehampton.
- 5 YM Capt. E. H. ROBINSON ... .. Langmead, Pirbright, Woking, Surrey.
- 5 YN
- 5 YO JAMES E. NOBLE ... .. 108, James Street, Golcar, nr. Huddersfield.
- 5 YP
- 5 YQ J. GALLSCHER ... .. 4, Havelock Terrace, Paisley.
- 5 YR F. HAROLD WEBBER, M.P.S. 14, Bridge Street, Tiverton, Devon.
- 5 YS
- 5 YT
- 5 YU
- 5 YV
- 5 YW R. S. WHITWELL ... .. 12, Sidney Street, Penn Road, Wolverhampton.
- 5 YX
- 5 YY
- 5 YZ

5 Z

- 5 ZA
- 5 ZB
- 5 ZC
- 5 ZD
- 5 ZE
- 5 ZF
- 5 ZG
- 5 ZH THEODORE ALLISON ... .. The Cromwell Engineering Co., 81, Oxford Avenue, S.W. 20.
- 5 ZI
- 5 ZJ
- 5 ZK
- 5 ZL
- 5 ZM
- 5 ZN
- 5 ZO W. F. MILLS, Assoc.I.R.E. ... .. 11, Stoney Hey Road, Wallasey, Cheshire.
- 5 ZP
- 5 ZQ H. JESSOP ... .. 5, Crest Place, Halifax Road, Brighouse, Yorkshire.
- 5 ZR F. H. AUSTIN ... .. 52, Church Street, St. Peter's, Broadstairs.
- 5 ZS
- 5 ZT
- 5 ZU H. B. GARDNER ... .. 129, Salisbury Road.
- 5 ZV WILL HERRING ... .. 221, Newark Road, Lincoln.
- 5 ZW
- 5 ZX T. L. RAWSON ... .. Bell Rock, Belfield Road, Didsbury, Manchester.
- 5 ZY
- 5 ZZ H. C. WHITBY ... .. The Ness, Winstford, Cheshire.

6 A

- 6 AA THE DURHAM & NORTHUMBERLAND COLLIERIES FIRE & RESCUE BRIGADE 854, Scotswood Road, Newcastle-on-Tyne.
- 6 AB THE DURHAM & NORTHUMBERLAND COLLIERIES FIRE & RESCUE BRIGADE 854, Scotswood Road, Newcastle-on-Tyne (Portable Set).
- 6 AC
- 6 AD S. MURCATROYD & R. WOODLAND 2, Glenwyllin Road, Waterloo, Liverpool.

6 AB

- 6 AF ROBERT H. RICE ... .. 70, Seaside, Eastbourne.
- 6 AG
- 6 AH R. H. P. COLLINGS ... .. 4, Dean Place, Liskeard, Cornwall.
- 6 AI H. ANDREWS ... .. Wireless Depot, Ystradgynlais.
- 6 AJ THE BARNSELY & DISTRICT WIRELESS ASSOCIATION 22, Market Street, Barnsley.
- 6 AK
- 6 AL JAMES P. MORTER ... .. 49, Westow Hill, Upper Norwood, S.E. 19.
- 6 AM
- 6 AN
- 6 AO
- 6 AP
- 6 AQ ARTHUR H. BIRD ... .. 35, Bellwood Road, Waverley Park, Nunhead, S.E. 15
- 6 AR
- 6 AS
- 6 AT
- 6 AU
- 6 AV F. A. ELLIFF... .. 10, Stumperlowe Park Road, Fulwood, Sheffield.
- 6 AW
- 6 AX
- 6 AY
- 6 AZ

6 B

- 6 BA
- 6 BB JOHN BOLT ... .. Crouchley Lymm.
- 6 BC W. DOUGLAS CRAIGUE ... .. White House, High Heworth, Gateshead-on-Tyne.
- 6 BD
- 6 BE
- 6 BF
- 6 BG
- 6 BH F. T. SCRAGG, A.M.I.E.E. Mayville, Meaford Road, Barlaston, Stoke-on-Trent.
- 6 BI
- 6 BJ
- 6 BK
- 6 BL
- 6 BN
- 6 BO L. C. HAGGER ... .. 35, Cunningham Park, Harrow.
- 6 BP A. E. HAYWARD ... .. Devonian, Higham Road, Tottenham, N. 15.
- 6 BQ J. L. CANNON ... .. 14, Woodcroft Avenue, Broomhill, Glasgow.
- 6 BR G. H. RAMSDEN ... .. 34, Queensborough Terrace, Bayswater Road, W. 2.
- 6 BS
- 6 BT C. A. JAMBLIN ... .. 82, York Road, Bury St. Edmunds
- 6 BU
- 6 BV V. F. M. OLIVER, A.M.I.E.E., B.A. Whitmore Lodge, Sunnyn Hill, Berks.
- 6 BW J. C. MASON, A.M.I.E.E. ... .. 3, Barnwell Avenue, Wallasey, Cheshire.
- 6 BX
- 6 BY
- 6 BZ

6 C

- 6 CA
- 6 CB
- 6 CC B. A. MATTHEWS ... .. Westgate, Frederick Road, Wyld Green, Birmingham.
- 6 CD
- 6 CE
- 6 CF WM. C. LINGARD ... .. Eridgeholme Green, Chapel-en-le-Frith.
- 6 CG
- 6 CH R. J. LEEVES ... .. Denmark Villa, Bromley, Kent.
- 6 CI
- 6 CJ
- 6 CK
- 6 CL
- 6 CM
- 6 CN
- 6 CO
- 6 CP
- 6 CQ
- 6 CR
- 6 CS
- 6 CT
- 6 CV P. H. DORTE... .. Lynwood, Oatlands Park, Weybridge, Surrey.
- 6 CW DAVID BURNE-JONES, F.R.S.A. Gwallior, Rustic Avenue, Stratford, S.W.
- 6 CX
- 6 CY
- 6 CZ

6 D

- 6 DA
- 6 DB
- 6 DC G. YOUNG ... .. 37, Barnard Road, Gorton, Manchester.
- 6 DD JOHN W. BARBER ... .. 205, Brockley Road, Brockley, S.E. 4.
- 6 DE
- 6 DF F. G. PHINNIMORE ... .. Andrew Lane Farm, High Lane, Stockport.
- 6 DG
- 6 DH
- 6 DI
- 6 DJ



6 DK F. A. BOYCE ... .. Pengun, Garson Lane, Wraysbury, Bucks.  
 6 DL  
 6 DM CAPT. C. KNIGHT-COUTTS, Vine Street, Evesham.  
 M.C.  
 6 DN  
 6 DO P. H. DORTE... .. Lynwood, Otlands Park, Weybridge, Surrey.  
 6 DP NORMAN CROWTHER... .. 219, Roundhay Road, Leeds.  
 6 DQ  
 6 DR  
 6 DS  
 6 DT  
 6 DU E. J. NEWTON ... .. 1, Jerningham Road, New Cross, S.E. 14.  
 6 DV  
 6 DW DOUGLAS H. JOHNSON ... .. Coombe Pines, Warren Cutting, Kingston Hill, Surrey.  
 6 DX  
 6 DY C. KEITH MURRAY ... .. Paultons Estate, Ower, Romsey, Hants.  
 6 DZ CAPT. L. A. K. HALCOMB ... .. South Dene, 106, Millhouses Lane, Sheffield.

6 F

6 FA G. E. WARDLE ... .. Kingsdown, College Road, N Blundellsands, Liverpool.  
 6 FB  
 6 FC L. S. Taylor ... .. 49, Frederick Street, Crosland Moor, Huddersfield.  
 6 FD F. T. CARTER ... .. Flat A., Gleneagle Mansions, Streatham, S.W.  
 6 FE  
 6 FF  
 6 FG N. HENDRY ... .. 30, Sanderson Road, Newcastle-on-Tyne.  
 6 FH G. W. LIVESLEY ... .. 3, Spring Bank, Market Drayton.  
 6 FI  
 6 FJ C. V. JARVIS ... .. Southleigh, 21, Baltic Road, Tonbridge, Kent.  
 6 FK F. A. CLARKE ... .. 48, Wilbury Road, Hove, Sussex.  
 6 FN  
 6 FO  
 6 FP  
 6 FQ A. B. RICHARDSON ... .. 9, Quarry Road, Hastings.  
 6 FR  
 6 FS  
 6 FT  
 6 FU W. H. TAYLOR ... .. 106, Bridge Street, Warrington.  
 6 FV  
 6 FW  
 6 FX  
 6 FY J. T. THORNTON, A.M.I.R.E. Green Hill, Birkley Lodge Road, Huddersfield.  
 6 FZ

6 G

6 GA  
 6 GB  
 6 GC  
 6 GD  
 6 GE  
 6 GF  
 6 GG A. W. EAGLE ... .. 126, Rosebury Avenue, Tottenham, N.17.  
 6 GH  
 6 GI  
 6 GJ  
 6 GK  
 6 GL F. L. GILES ... .. 201, Higham Hill Road, Walthamstow, E.17.  
 6 GM E. ANSLOW WILSON ... .. 42, Heber Road, N.W.2.  
 6 GN TYNEMOUTH VOLUNTEER LIFE BRIGADE Brigade House, Tynemouth.  
 6 GO LEONARD A. SAYCE... .. 5, Toward Terrace, Sunderland.  
 6 GP  
 6 GQ JAMES STEPHEN SOUTER ... .. Greyfriars, Ironworks, Elgin, Morayshire.  
 6 GR JOHN S. SCOTSON ... .. 93, Entwistle Road, Rochdale.  
 6 GS  
 6 GT  
 6 GU  
 6 GV  
 6 GW PERCY BRIAN. M.Sc. ... .. 79, Lakey Lane, Hall Green, Birmingham.  
 6 GX C. REYNOLDS ... .. 71, Siddall Street, Oldham.  
 6 GY T. Mc L. GALLOWAY ... .. Wyntersted, Dollar, Clackmannanshire.  
 6 GZ R. C. NEALE ... .. Farnborough Road, Farnborough, Hants.

6 H

6 HA  
 6 HB  
 6 HC H. COOPER ... .. "Morning Dawn," Burnt Ash Lane, Bromley, Kent.  
 6 HD  
 6 HE  
 6 HF  
 6 HG A. FRANKS, LTD. ... .. 95-7, Deansgate, Manchester.  
 6 HH ALEC R. E. JENNINGS, Hon. Sec. Glevorn Radio Soc. Caxton House, Gloucester.  
 6 HI  
 6 HJ  
 6 HK J. W. F. CARDELL ... .. "Theobalds," Newquay, Cornwall

6 HL  
 6 HM HUGH E. DAFT ... .. 31, Eastfield Road, Peterborough;  
 6 HN  
 6 HO  
 6 HP  
 6 HQ  
 6 HR W. D. KEILLER ... .. 51, Highworth Road, New Southgate, N.11.  
 6 HS H. SAVILL ... .. 1, Delamere Avenue, Stretford, Manchester.  
 6 HT  
 6 HU  
 6 HV  
 6 HW  
 6 HX  
 6 HY  
 6 HZ

6 I

6 IA  
 6 IB  
 6 IC ARNOLD JOWETT ... .. 310, Hopwood Lane, West End, Halifax.  
 6 ID  
 6 IE  
 6 IF  
 6 IG  
 6 IH  
 6 II  
 6 IJ  
 6 IK  
 6 IL  
 6 IM  
 6 IN  
 6 IO  
 6 IP  
 6 IQ HEDLEY FORSHAW ... .. 45, High Street, Standish, near Wigan.  
 6 IR  
 6 IS  
 6 IT  
 6 IU  
 6 IV P. B. SNOADEN ... .. 68, Hide Road, Harrow.  
 LEEDS Y.M.C.A. WIRELESS SOCIETY Albion Place, Leeds, Hon. Sec.; P. Whiteley.  
 6 IX W. G. FUDGER ... .. "Brora," Priorswood Road, near Godalming.  
 6 IY  
 6 IZ

6 J

6 JA  
 6 JB  
 6 JC  
 6 JD  
 6 JE  
 6 JF  
 6 JG  
 6 JH  
 6 JI  
 6 JJ J. ORD PENDER SMITH ... .. "The Croft," Dingwell, N.B.  
 6 JK  
 6 JL P. N. GOULSTON ... .. "Edgeleigh," Warwick Avenue, Coventry.  
 6 JM  
 6 JN  
 6 JO J. RODGERS ... .. 13, Arwenack Street, Falmouth, Cornwall.  
 6 JP  
 6 JQ  
 6 JR  
 6 JS PERCY R. SOLDER ... .. 76, Albert Road, Alexandra Park, N. 22.  
 6 JT  
 6 JU  
 6 JV CAPT. H. J. B. HAMPSON ... .. 477, Earham Rise, Norwich.  
 6 JW V. PLASCOTT .. .. 39, Waterloo Road, Southampton.  
 6 JX  
 6 JY  
 6 JZ VVYAN, A. G. BROWN ... .. Fawley Lodge, Coley Avenue, Reading.

6 K

6 KA  
 6 KB EDWARD H. WILDING ... .. 306, Gidlow Lane, Wigan, Lancashire.  
 6 KC R. A. FARMERY ... .. 136, Shear Brow, Blackburn.  
 6 KD C. G. BEVAN, B.Sc., A.M.I.E.E. Technical College, Cardiff.  
 6 KE  
 6 KG  
 6 KH  
 6 KI CHARLES D. KIDD ... .. 33, Berkeley Road, Bishopston, Bristol.  
 6 KJ WALTER KROHN ... .. 18, Highcroft Gardens, Golders Green, N.W. 11.  
 6 KK JOHN COOKSON ... .. 66, Albert Road, Blackpool.  
 6 KL  
 6 KM  
 6 KN  
 6 KO  
 6 KP  
 6 KQ  
 6 KR  
 6 KS  
 6 KT  
 6 KU H. G. CLACY ... .. 114, Bradshaw Road, Watford, Herts.



6 KV  
6 KW  
6 KX  
6 KY  
6 KZ

6 L

6 LA  
6 LB L. J. FULLER ... 13, Seary Road, Wanstead, Essex.  
6 LC  
6 LD H. HORROCKS ... 23, Mount Avenue, Littleborough, Manchester.  
6 LE  
6 LF GEORGE W. HALL ... 7, Acton's Walk, Chapel Lane, Wigan.  
6 LG  
6 LH  
6 LI  
6 LJ  
6 LK  
6 LL  
6 LM  
6 LN  
6 LO  
6 LP  
6 LQ  
6 LR  
6 LS  
6 LT  
6 LU A. WOODMANSEY, M.Sc. ... 8, Church Avenue, Harrogate.  
6 LW R. C. DAVIES ... Sunny Side, Grainger's Lane, Cradley Heath, Staffs.  
6 LX  
6 LY  
6 LZ

6 M

6 MA  
6 MB  
6 MC J. A. BADHAM ... 114, Fitzwilliam Street, Huddersfield.  
6 MD  
6 ME  
6 MF SIDNEY HILL ... Langford, nr. Bristol.  
6 MG B. W. D. LACEY ... 197, Alcester Road South, King's Heath, Birmingham.  
6 MH  
6 MI  
6 MJ H. A. FREER ... 110, Humberstone Drive, Leicester  
6 MK R. WILBY ... 93, Brudenell Road, Hyde Park, Leeds.  
6 ML  
6 MM  
6 MN  
6 MO  
6 MP  
6 MQ G. C. PATCHING ... 84, Allcroft Road, Kentish Town N.W. 5.  
6 MR  
6 MS  
6 MT W. HAVARD LILES ... 21-22, Edwards Terrace, Cardiff.  
6 MJ  
6 MV  
6 MW  
6 MX Y. W. P. EVANS, M.I.R.E. ... 2, Parkside Road, Alexandra Park, Manchester.  
6 MY  
6 MZ H. H. MOULD ... Hilbre, Richmond Road, Wolverhampton.

6 N

6 NA  
6 NB  
6 NC  
6 ND  
6 NE  
6 NF ALFRED D. GAY ... 49, Thornlaw Road, W. Norwood, S.E. 27.  
6 NG J. W. CROPPER ... 10, Manor Street, Audenshaw, near Manchester.  
6 NH J. W. DAVIES ... Doddington, Caterham Valley, Surrey.  
6 NI  
6 NJ C. W. WATSON ... 33, Rainhall Road, Barnoldswick.  
6 NK  
6 NL THE BRITISH RADIO MANUFACTURING CO. ... 9, South Castle Street, Liverpool.  
6 NM  
6 NN  
6 NO  
6 NP WILLIAM GILL ... 7, Church View, Heckmondwike, Yorks.  
6 NQ L. B. PARKES ... 102, Lichfield Street, Walsall, Staffs.  
6 NR NORMAN RUSHTON ... 10, Ashley Street, Manchester Road, Bradford.  
6 NS  
6 NT H. PLUMER ... 20a, Tradesant Road, South Lambeth Road, S.W. 8.  
6 NU  
6 NV  
6 NW  
6 NX  
6 NY  
6 NZ W. B. CHIVERS ... 115, Arden Road, Birchfield, Birmingham.

6 O

6 OA  
6 OB  
6 OC LT.-COL. E. C. JENNINGS ... "Gelli-deg," Kidwelly, S. Wales.  
6 OD  
6 OE  
6 OF  
6 OG  
6 OH  
6 OI  
6 OJ  
6 OK W. JONES ... Tegwel, Penybryn, Upper Colwyn Bay, N. Wales.  
6 OL  
6 OM IAN AUCHTERLONIE ... The Gables, Heswall, Gheshire.  
6 ON W. H. FELTON ... 47, Sompting Road, Broadwater, Worthing.  
6 OO  
6 OP  
6 OQ  
6 OR  
6 OS  
6 OT  
6 OU  
6 OV  
6 OW JAMES P. BROWN ... 18, May Street, Hamilton, Lanarkshire.  
6 OX  
6 OY PATRICK L. F. JONES ... 13r, Hampstead Way, Golders Green, N.W. 11.

6 P

6 PA  
6 PB  
6 PC  
6 PD A. J. DIXON ... White House, 74, Hertford Road, Enfield Wash, Middlesex.  
6 PE  
6 PF F. M. COOPER ... 22, Guest Road, Endcliffe, Sheffield.  
6 PG C. H. TARGETT ... 21, High Street, Dartford, Kent.  
6 PH  
6 PI  
6 PJ F. ISON ... 47, Orford Road, Walthamstow, E. 17.  
6 PK  
6 PL J. F. BROCKBANK ... 51, Palatine Road, Withington, Manchester.  
6 PM  
6 PN  
6 PO  
6 PP  
6 PQ FRED W. EDWARDS ... "Fair Haven," Castle Gresley, near Burton-on-Trent.  
6 PR J. P. PRICE ... Coombehurst, Coombe Hill Road, E. Grinstead, Sussex.  
6 PS  
6 PT LEONARD LOTT, ... "Gants Muir," Berrow Road, Burnham-on-Sea.  
6 PU  
6 PV  
6 PW  
6 PX  
6 PY  
6 PZ

6 Q

6 QA ARTHUR H. ARNOLL ... 40, Springwell Avenue, Harlesden, N.W. 10.  
6 QB L. H. THOMAS ... 33, Harpenden Road, West Norwood, S.E. 27.  
6 QC H. J. STAMPER ... The Grammar School, Loughborough.  
6 QD  
6 QE  
6 QF  
6 QG C. G. CAKLTON ... "Horn Park House," Lee, S.E. 12.  
6 QH  
6 QI  
6 QJ  
6 QK  
6 QL  
6 QM  
6 QN  
6 QO CYRIL J. DEAL ... The Limes, Kelvedon, Essex.  
6 QQ  
6 QR  
6 QS  
6 QT  
6 QU ARTHUR EATON ... 21, Dashwood Road, Prestwich, Manchester.  
6 QV A. I. RICH ... 13, New Road, Ponder's End, Middlesex.  
6 QW  
6 QX  
6 QY  
6 QZ W. R. EMERY ... 39, Kilmorey Gardens, Twickenham.

6 R

6 RA  
6 RB  
6 RC  
6 RD  
6 RE  
6 RF



— for a  
complete  
and  
effective  
campaign

IN  
RADIO  
ADVERTISING

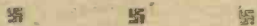

**WIRELESS  
MODERN  
WIRELESS  
WIRELESS  
CONSTRUCTOR  
WIRELESS  
WEEKLY  
THE WIRELESS  
DEALER**

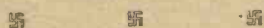

Enquiries for space  
should be addressed to

The Advertisement Manager

Barclays Advertising Ltd.,  
Bush House, Strand,  
London - - - - W.C. 2.

Telephone: City 9911 (Six lines).

Stop that  
**FILAMENT  
VIBRATION!**

get purer tone  
by using this  
shock absorbing  
valve holder

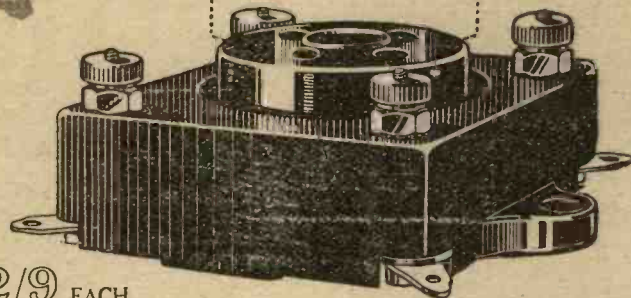

2/9 EACH.

This new shock - absorbing socket prevents the transmission of outside noises and vibrations to the filaments. The effects of street traffic, indoor footsteps and resonance (often inaudible to the human ear and yet constantly causing distortion), are completely dissipated because the valve

is securely floated on delicately adjusted springs. So strongly constructed are these springs that the tightest valve can be inserted or removed without fear of damaging them. EACH SPRING HAS ONE TURN ONLY. Bakelite construction ensures high insulation, low capacity and sturdiness.

There are terminal connections for the experimenter and soldering tags for the permanent set. The Benjamin Clearer Tone Valve Holder is easily cleaned—little or no dust can collect in the sockets.

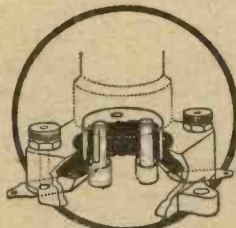

Sectional View.

The springs themselves form the valve pin sockets. No soldered joints—all one solid metal piece from tag to valve leg. No flexible wire connections. The spring supports are not affected by stiff busbar wiring. FOR GOOD RECEPTION WITH DULL EMITTER VALVES BENJAMIN CLEARER TONE ANTI-MICROPHONE VALVE HOLDERS ARE ESSENTIAL.

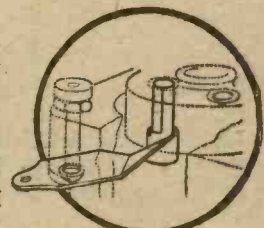

Spring feature.

**BENJAMIN  
CLEARER TONE VALVE HOLDER**  
(ANTI-MICROPHONIC)

Pats. Pending.

FROM YOUR DEALER OR DIRECT FROM

**THE BENJAMIN ELECTRIC LIMITED**  
Brantwood Works, Tariff Rd., TOTTENHAM, N.17

The Benjamin Battery Switch gives perfect battery current control, 2/- each.



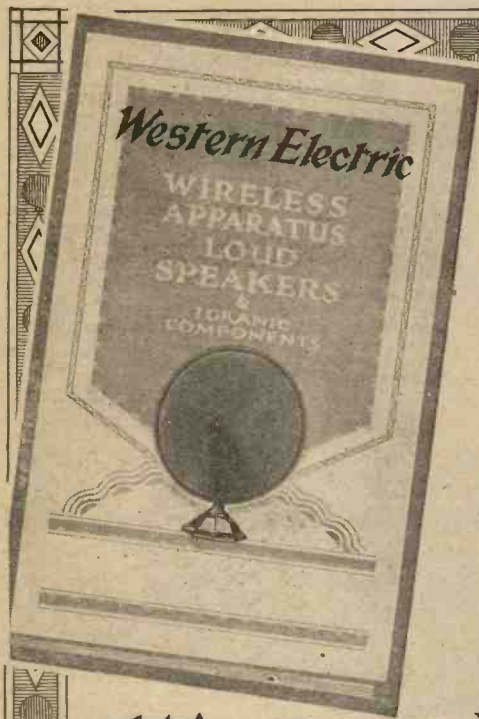

# New Apparatus for the Autumn Season

*Write at once  
for this Booklet*

GIVING DETAILS OF OUR  
NEW APPARATUS.  
LOOK OUT FOR OUR  
LOUD SPEAKER

The **KONE**  
*The Speaker that will revolutionise  
broadcast reception*



## Western Electric

CONNAUGHT HOUSE, ALD'VYCH, W.C.2.

Telephone: Central 7345 (9 lines).

BRANCHES: Glasgow, Leeds, Manchester,  
Newcastle, Birmingham, Cardiff, Southampton,  
Liverpool, Dublin.

Advt. of Western Electric Co., Ltd., Connaught House, Aldwych, London, W.C.2.

**"It's contact that counts!"**

says **CLIXIE**



**"CLIXIE"**

At Home  
The Albert Hall  
Sept. 12 — 23.

"A radio circuit is as efficient as its weakest connection," says CLIXIE. "So when you suspect faults in your wiring look to your connections first. "Two-point' contact—and 'touching' contact at that—is perhaps the commonest form of weakness. It's the outstanding attribute of those ingenious silly little wiring gadgets to which the sanest of us occasionally falls victim. And it simply won't do. "Nothing will do short of full surface contact, constantly maintained. And that's why nothing will do but the plugsocket CLIX. "The ingenious design of CLIX provides a large area of contact surface with the minimum of capacitive metal in both plug and socket. Hence the CLIX supremacy over every other form of plug, switch or terminal."

Are you well connected? Try  
**CLIX**

The Electro-Link with 159 Uses.

AUTOVEYORS, LTD., 84 VICTORIA STREET, LONDON, S.W.1.



**No. 1 W.**

Standard Pocket  
Lamp Size—  
4½ volt with  
patent spiral  
wire terminals  
and plug sockets  
to take Wander  
Plugs.

Note:—1 doz. = 5½  
volts.

Used units replaced  
easily.

Connect as illustrated



To connect in  
Series insert  
straight Ter-  
minal in Spiral  
of next battery.  
Bend spiral and  
thus ensure per-  
manent electrical  
connection with-  
out soldering.

Guaranteed  
BRITISH MADE  
at our  
Watford Works.  
Patent No. 202762.

PRICE CARRIAGE PAID 7/- PER DOZ., WITH PLUG



Prices in-  
clude Wan-  
der Plug.  
Carriage  
paid.

Each.  
No. 2W, 16½ volts, 3 volt tappings. Price 3/-  
No. 4W, 36 " " " " " 6/-  
No. 5W, 60 " " " " " 12/-  
No. 6W, 9 volts, Grid, 1½ volts tapping, " 2/3

## BRITISH BATTERY Co., Ltd.

CLARENDON ROAD, WATFORD, HERTS. (Telephone: Watford 617.)

Barclays 1029



6 RG  
 6 RH  
 6 RI  
 6 RJ  
 6 RK  
 6 RL K. GREGSON ... .. 2, Laurel Avenue, Blackpool.  
 6 RM A. E. MACFARLANE ... .. 30, Vincent Road, Addiscombe, E. Croydon.  
 6 RN  
 6 RO  
 6 RP  
 6 RQ B. C. THOMAS ... .. 93, Bryncaerau Terrace, Llanelly.  
 6 RR  
 6 RS F. C. SMART ... .. "The Retreat," Fields Park Road, Newport, Mon.  
 6 RT  
 6 RU  
 6 RV  
 6 RW EDWARD T. SALMON ... .. 15, Delamain Road, West Derby, Liverpool.  
 6 RX  
 6 RY H. LESLIE BOWER ... .. 13, Daniel Street, Bath, Somerset.  
 6 RZ

6 S

6 SA PROFESSOR A. M. LOW ... .. The Yews, Woodstock Road, Bedford Park, W.  
 6 SB  
 6 SC  
 6 SD  
 6 SE  
 6 SF  
 6 SG L. W. MANT ... .. 35, Jessil Road, Southsea.  
 6 SH SYDNEY HEALD ... .. 2, Market Street, Chorley, Lancs.  
 6 SI  
 6 SJ  
 6 SK A. E. VOLLMER ... .. 57, Lyttelton Road, Leyton, E. 10.  
 6 SL  
 6 SM  
 6 SN  
 6 SO  
 6 SP  
 6 SQ  
 6 SR R. T. HATTON EVANS ... .. 6, Court-y-vil Road, Penarth.  
 6 SS F. C. HOLLIDAY ... .. Forest Hill, Park Villas, Roundhay, Leeds.  
 6 SU  
 6 SV E. S. STANLEY ... .. Marlborough House, Parkside Road, Reading.  
 6 SW  
 6 SX  
 6 SY  
 6 SZ KENNETH RILEY, B.Sc. ... .. 13, Park Avenue, Burnley, Lancs.

6 T

6 TA  
 6 TB  
 6 TC  
 6 TD  
 6 TE  
 6 TF  
 6 TG  
 6 TH C. W. LILES ... .. "Helena," 52, York Place, Newport.  
 6 TI LESLIE BALDWIN ... .. 244, Dudley Hill Road, Undercliffe, Bradford.  
 6 TJ  
 6 TK J. H. SMITH, F.R.A.S. ... .. Duke Street, Dartmouth, S. Devon.  
 6 TL W. A. S. BUTEMENT ... .. 127, West End Lane, N.W. 6.  
 6 TM  
 6 TN  
 6 TO  
 6 TP  
 6 TQ  
 6 TR  
 6 TS  
 6 TT  
 6 TU J. K. BYERS ... .. 33, Richmond Avenue, Margate.  
 6 TV JOSEPH NODEN ... .. "Fern Villa," Coppice Road, Willaston, Nr. Nantwich.  
 6 TX J. E. FYNN ... .. "Maxwell," 12, Monkhams Avenue, Woodford Green, Essex.  
 6 TY W. JONES ... .. 37, Lakefield Road, Llanelly.  
 6 TZ

6 U

6 UA  
 6 UB  
 6 UC A. C. CHATWIN ... .. 162, Hagley Road, Edgbaston, Birmingham.  
 6 UD  
 6 UE  
 6 UF  
 6 UG  
 6 UH  
 6 UI  
 6 UJ  
 6 UK  
 6 UL  
 6 UM  
 6 UN  
 6 UO

6 UP  
 6 UQ  
 6 UR  
 6 US NISBET E. READ ... .. Ty-Rhos, Llandrinio, Llanymynech, Montgomery.  
 6 UT T. A. ST. JOHNSON ... .. 28, Douglas Road, Chingford, Essex.  
 6 UU  
 6 UV G. L. MORROW ... .. Penolver, Berkhamsted, Herts.  
 6 UW  
 6 UX  
 6 UY HARRY NORMAN GRAY ... .. 78, High Street, Barry.  
 6 UZ W. M. BAKEWELL ... .. Yeovil House, Regent Street, Stoke-on-Trent.

6 V

6 VA  
 6 VB  
 6 VC  
 6 VD  
 6 VE  
 6 VF  
 6 VG  
 6 VH  
 6 VI H. BRENCHLEY ... .. 93, Springfield Road, Moseley, Birmingham.  
 6 VJ  
 6 VK JAMES H. BEAN ... .. Moorview, Toller Lane, Bradford.  
 6 VL R. W. LEADER ... .. Porth, St. Columb Minor, Cornwall.  
 6 VM  
 6 VN F. W. WELLBELOVE ... .. 37, St. John's Road, Erith, Kent.  
 6 VO  
 6 VP ALAN SMITH ... .. 48, High Street, Yiewsley, Middx.  
 6 VQ  
 6 VR  
 6 VS  
 6 VT  
 6 VU  
 6 VV  
 6 VW  
 6 VX T. ST. G. LEIGH CLARKE ... .. 132, Grove Green Road, Leytonstone, E.  
 6 VY  
 6 VZ

6 W

6 WA  
 6 WB  
 6 WC  
 6 WD  
 6 WE  
 6 WF  
 6 WG ROBERT CARLISLE ... .. 40, Walton Street, Glasgow.  
 6 WH E. W. & H. J. KIRK ... .. 2, Riddings Street, Derby.  
 6 WI  
 6 WJ  
 6 WK  
 6 WL J. T. DICKINSON ... .. 1, St. Austell Road, Lewisham Hill, S.E. 13.  
 6 WM  
 6 WN  
 6 WO  
 6 WP  
 6 WQ  
 6 WR  
 6 WS L. I. NEAVERSON ... .. Northants Wireless Co., 40, Cowgate, Peterborough.  
 6 WT  
 6 WU  
 6 WV V. W. CROOK ... .. 26, Kenwyn Road, West Wimbledon, S.W.  
 6 WW  
 6 WX  
 6 WY  
 6 WZ

6 X

6 XA  
 6 XB  
 6 XC  
 6 XD  
 6 XE  
 6 XF DONALD B. KNOCK ... .. 34, Claremont Road, Birkdale, Lancs.  
 6 XG  
 6 XH  
 6 XI  
 6 XJ  
 6 XK  
 6 XL  
 6 XM  
 6 XN  
 6 XO  
 6 XP  
 6 XQ  
 6 XR  
 6 XS  
 6 XT S. G. W. FARMERY ... .. The Moorlands, Whinfield, Adel, Nr. Leeds.  
 6 XU  
 6 XV  
 6 XW  
 6 XX  
 6 XY FRANK CROPPER ... .. 42, Acres Lane, Stalybridge, Cheshire.  
 6 XZ M. MARSHALL ... .. Beach View, Island Road, Newquay, Cornwall.



K. RAYMOND

ALL GOODS POST FREE U.K. except where stated. Foreign orders over £10 post free, otherwise please send ample for post, etc. Trade orders U.K. less 20%. Post extra. Open all day Saturday.

SEE OUR ADDRESS ON OPPOSITE PAGE

ACCUMULATORS (New). 2 volt, 40 amps. . . 9/6. 10/6

EDISON BELL. Series Parallel Variometer 18/6 (B.B.C. & 5xx)

IGRAMIC. Ultronic Coil . . . 7/8 Unitune Minor, 80/180 . . . 9/-

McMICHAEL "M.H."-contd. Fixed Condensers and Clips. . . 1/9

SUCCESS. L.F. Super (All Black) 21 Standard, 1st Stage. . . 18/-

L.F. TRANSFORMERS-contd. Gaumbell. 1st or 2nd Stage ea. 27/6

ATHOL. Valve Holder . . . 1/3 Coil Plug . . . 1/3

GOSWELL. (Quality Radio). Octis (Mounted). 25 . . . 1/3 35 . . . 1/9

One hole fixings. 30 . . . 4/3 35 . . . 4/3

MAGNUM. (Burne, Jones, Ltd.) H.F. Transformers, etc. 1/-

SHIPTON. Rheostats. 7. 30, 60 ohms . . . 3/6

UTILITY. Variable Condensers. Square Law and Vernier, Knob and Dial. . . 11/3

BOWYER-LOWE. Low Loss Coil Former . . . 5/- H.F. Transformers, each 7/-

2-way Panel Stand . . . 3/- 3-way Panel Stand . . . 5/-

Variable Condensers, Sq. Law. 300 . . . 21/- 0005 . . . 24/-

COIL HOLDERS. 2-way "E" or "L" . . . 9/8 3-way . . . 12/6

SUNDRIES. Coil Stands. 2-way Long Handle . . . 2/6

"UNIDYNE". THORPE K4 VALVES. Guaranteed Genuine. Owing to great demand please place your orders early.

BURDEPT. Rheostat 47 ohms . . . 5/- Dual Rheostat . . . 7/-

GAMBRELL. Neutrodyne Condenser . . . 7/9 L.F. Transformers, 1st or 2nd stage . . . 27/6

LOTUS. (Geared). 2-way Stand . . . 7/- 3-way Stand . . . 10/8

MICROMETER. Vernier is a wonderful little article, 24 turns of tuning adjustment. Stage 1in. hole fixing.

PULAR. (Radio Comm. Co.) Cam Vernier 2-way . . . 6/- Ditto, 3-way . . . 9/-

VALVE HOLDERS. 1 Valve Set . . . 46/6 1/3 2 Valve Set . . . 68/6

CONDENSERS NEUTRODYNE. Colvern . . . 3/8 Success . . . 3/6

H.T. C. Valve Holder . . . 1/9 Ditto, "C" . . . 1/6

LOUD SPEAKERS. Sterling Dinkle . . . 30/- Sterling Baby . . . 50/-

NEW VARIABLE AIR CONDENSERS. 0005 . . . 24/- 0003 . . . 22/6

RE-ECHO. Crystal Receiver. (One with a name behind it.) All usual wavelengths covered by inserting suitable coils.

VALVE HOLDERS. 18/6 each. 1/3 Marconi DE3. 18/6 each.

CRYSTALS. The best only. Shaw's Genuine Hertzite, in Sealed Box . . . 1/-

H.T. BATTERIES. 36 volt B.B.C. . . . 6/3 60 volt B.B.C. . . . 8/6

LISEN. L.F. T1 . . . 30/- T2 . . . 25/-

REFLEX COILS. No. 35 150 200 . . . 8d. No. 80 200 300 . . . 9d.

T.C.B. Filament Resistances. 6, 15, 30 ohms ea. 4/6

WOODHALL. Vernier Rheostat, 60 ohm, 2 1/2, 30 ohms 3/6

COILS-AIR SPACED. Ledion New Type. Yellow Boxes, Patent Number 2029233.

HEADPHONES. British, 4,000 ohms. Sterling . . . 22/6 B.T.H. . . . 20/-

MARCONIPHONE. Potentiometer . . . 11/6 Ideal L.F. . . . 35/-

STERLING. Triple Coil Holder . . . 20/- Ditto, on Standards . . . 22/6

T.C.C. MANSBRIDGE. 2 M.F.D. . . . 4/8 1 M.F.D. . . . 3/10

WATWEL. Variable Grid Leak . . . 2/6 Anode Resistance . . . 3/6

DUBILLES. Fixed Condensers. 0001, 2, 3, 4, 5 . . . ea. 2/6

HEADPHONES-contd. Ericsson E.V. (Continental) 4,000 ohms . . . 12/-

McMICHAEL "M.H.". H.F. Transformers, ea. 10/-

T.C.C. MANSBRIDGE. 2 M.F.D. . . . 4/8 1 M.F.D. . . . 3/10

L.F. TRANSFORMERS. Pye (650), 1st Stage. . . 22/6

WOODHALL. Vernier Rheostat, 60 ohm, 2 1/2, 30 ohms 3/6

DELIVERY GIVEN AT THE EARLIEST POSSIBLE MOMENT, BUT NO RESPONSIBILITY ACCEPTED FOR MANUFACTURERS' DELAYS, LOCK-OUTS, STRIKES OR ANY CAUSE OVER WHICH I HAVE NO CONTROL.

HALES AERIAL CONTROL. Keeps Wire Taut ... 2 for 2/- WATES MICROSTAT ... 2/9

WEST-END LEADING STOCKIST FOR Edison Bell, Jackson's (J.B.), Polar, Igramic, Peerless, Eureka, Magnum, Burndep, Lotus, Dubilier, Marconi, Dorwood, Sterling, Success, B.T.H., McMichael, Liszen, Woodhall, Utility, R.L., Bowyer-Lowe, Amplion, Formos, Brunet, Ormond, parts, etc.

HOURS OF BUSINESS Daily 9 a.m. to 8 p.m. Sundays, 11 to 1. Open all day Saturday Two shops, one always open. Telephone (private line) GERRARD 2821.



# HULLO!

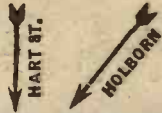

# EVERYBODY



**K. RAYMOND**  
PLEASE NOTE →

This is the NEW OXFORD STREET END of Shaftesbury Avenue, Grape St. is between Mudie's Library and New Princes Theatre. It is ONE minute's walk from TOTTENHAM COURT RD. TUBE. 3 minutes' walk from HOLBORN TUBE. 2 minutes' walk from PALACE THEATRE, Cambridge Circus.

**HOURS OF BUSINESS**  
Daily 9 a.m. to 8 p.m.  
Sundays, 11 to 1.  
Open all day Saturday  
Two shops, one always open.  
Telephone (private line) Gerrard 2821.

**SECOND-HAND GOODS.**  
Patronise the live firm!

I will accept in part payment for new goods (or purchase if so desired) any articles you have no use for. This is a stunning offer, so don't forget to take advantage of it. Make out your list of what you have to sell, and I will offer you best prices. This applies to post or callers.

**Very Important — Space costs MONEY.** To avail yourself of our very special offers which mean **POUNDS** to you, just send us a postcard with your name and address (Postcard only please), and our lists follow immediately.

**VERY IMPORTANT.** This list is a fairly comprehensive one, but if you will make out your requirements, giving goods actually wanted, makers' names, etc., I will Quote You Lowest possible inclusive Prices.

**VALVES.** To encourage you to use British Valves I am willing to purchase one burnt-out valve for each valve you purchase. Prices given range from 1/3 to 4/- according to valve you buy.

**EBONITE 3/16 stock sizes.**  
8 x 6 .. 2/6  
9 x 6 .. 2/8  
10 x 8 .. 3/6  
12 x 9 .. 5/-  
12 x 12 .. 6/6  
14 x 10 .. 6/6  
Cut to size 3d.  
per sq. inch.  
Repeat increased price owing to rubber advance.

**RAYMOND'S VARIABLE CONDENSERS**  
SQUARE LAW LOW LOSS.



**ONE HOLE FIXING. EBONITE ENDS. With Vernier**  
.001 ... 8/6  
.0005 ... 7/6  
.0003 ... 7/-  
**Without Vernier**  
.001 ... 7/6  
.0005 ... 5/9  
.0003 ... 5/3  
Including knob and dial. Post 3d. set.



**ORMOND "AMERICAN" Square Law Low Loss. Skeleton Ends, Knob and Dial.**  
.001, 9/- : .0005, 8/-  
.0003, 7/6 : .00025, 6/6  
With Vernier, 1/6 each extra.

**JACKSON BROS. ("J.B.")**

Square Law	Square Law with Vernier
.001 ... 9/6	.001 ... 13/6
.0005 ... 8/-	.0005 ... 12/6
.0003 ... 6/9	.0003 ... 11/6
.0002 ... 6/9	.0002 ... 11/3
<b>STANDARD</b>	
.001 ... 8/6	.0005 ... 7/-
.0003 ... 5/9	.0002 ... 5/-

Knob and dial free. Post 3d. set.

**ORMOND "No. 3." Ebonite Ends**  
Square law and vernier.  
.001 ... 10/6  
.0005 ... 9/6  
.0003 ... 9/-  
1/8 each less without vernier. Knob and dial free. Post 3d. set.

**This is the House for Highest Quality Components.**  
Try us.

**These two Columns CALLERS ONLY**  
ALL POST ORDERS FROM OTHER COLUMNS

Terminals, Nut and Washer W.O. ... 1d.	Panel Switches.	Nickel DPDT, 1/- SPDT 10/d.
Extra Large auto ... 3 for 4s.	Telefunken. Adjustable 'phones, 4,000 ohms, guaranteed genuine, 14/11 pr.	
Nickel, 2d. each ... doz. 1/6		
Valve Sockets ... 2 for 1/4d.		
Valve Pins and Nuts ... 2 s 1d.		
2, 4, 6, BA Nuts ... 6 s 1d.		
2 or 4 BA Washers ... 72 s 1d.		
2 BA Rod, best ... foot 2/4d.		
4 BA Rod, best ... foot 2d.		
Spade Taps ... 6 s 1d.		
Soldering "Nickel" ... 3 s 1d.		
Screwed Spades ... 2 for 1/4d.		
Screw Pins ... 2 for 1/4d.		
Bakery Clips ... 5 for 3d.		
Copper Foil, 6 in. ... foot 3s.		
Large Sleeving ... yard 1/4d.		
Screw Wander Plugs ... pr. 2/4d.		
Extra Quality Plugs ... pr. 4/4d.		
Contact Studs, complete ... 2 s 1d.		
Phone Connectors ... 1d.		
Spade Terminals (red or black) ... 1/4d.		
Plug and Socket (red or black) ... 3d.		
Pinch Panel Sockets with 2 outs ... 1d.		
Twin Flex, 12 yards ... 1/5		
Red and Black ditto, 12 yards ... 1/6		
Phone Cord, 6 ft., rubber ins. ... 1/6		
Loud Speaker, Cord, 20 ft. ... 2/11		
Ditto, 12 ft. ... 1/11		
Valve Templates ... 2d.		
Ribbon Aerial, 100 ft. ... 1/70		
7/22 Hard Drawn, 100 ft. ... 1/70		
Adhesive Tape Roll ... 3s.		
Empire Tape, doz. yds. ... 6s.		
Brest Drills, with double pinion cut gear ... 4/8		
Valve Windows ... 6d.		
ORMOND Machine Screws ... 9/4d.		
Enclosed Detector ... 1/-		
Ditto, Large Brass ... 1/3		
Ditto, Terminal Fitting ... 1/3		
Ditto, Half Opal ... 1/8		
Ditto, Half Opal, Nickel ... 1/8		
Ditto, Micrometer ... 1/8		
Micrometer, trigger movement ... 5/-		
Climax Earth Tubes ... 2/11		
"Opera" Earth Tubes ... 6d.		
Twin Silk Flex Miniature, 6 yds. ... 1/11		
'Phone Connector Boards ... 3/6		
Brownie ditto ... 4/4d.		
Ebonite Coil Plugs, plain ... 6d.		
Ditto, wedge ... 7d.		
Fluted Fibre ... 1/10		
Edison Bell ... 1/10		
Basket Holders ... 3/4d.		
Spike and Plug ... 9d.		
Bus Bar Square, 1 1/8 in., 12 ft., 6d., 18 gauge ... 5d.		
Ins. Hooks ... 2 for 1/4d.		
Ditto, Staples ... 6 s 1d.		
Variometer, 250-650 ... 1/8		
Lead-in, 10 yds. ... 1/-		
Extra Heavy ... yd. 2s. 3d.		
Coil Formers, 46 spokes ... 1/-		
Crystal Set, Sloping Cabinet, fitted for 5KX, Leatherette Case, guaranteed a perfect instrument ... 9/8		
Twin Bell Wire ... yd. 2d.		
DC, HRC Bell Wire ... 10 yds. 5d.		
DDP, China Base, 1/3 SPDT 10/4.		
ERICSSON EV (Continental), 4,000 ohms, per pair, 10/8.		
N. & K. GENUINE, 4,000 ohms 12/11		
Davenport, 1600, Coils 1/-, 1/3 3/8		
Ledion New Model ... 2/-		
Airspaced 1/4 in., set of 5 BBC ... 1/9		
Ledion New Model ... 3/6		
2-way Coil Stands ... 1/11		
3-way Coil Stands ... 3/3		
2-way Cam Vernier ... 3/8		
2-way Geared ... 4/- 4/6		
3-way Geared ... 5/11		
Shaw's Genuine Herzite ... 6d.		
Wonder Aerial, 49 strands ... 1/4		
100 ft. best quality 3/- 2nd qual. 1/8		
DCO Wire, 1lb. reels.		
18 ... 9d.		
22 ... 10d.		
26 ... 1/- 28 ... 1/1		
L.F. Transformer, 5-1 ... 7/-		
<b>EBONITE, 3/16.</b>		
6 x 6 or 7 x 5 ... 1/8		
8 x 6 or 9 x 6 ... 1/11		
10 x 8 or 12 x 6 ... 3/3		
12 x 12 or 14 x 10 ... 6/-		
<b>ACCUMULATORS.</b>		
Two High-Class Makes.		
2 v 40 amps. ... 7/6 8/3		
2 v 60 amps. ... 10/6 11/9		
2 v 80 amps. ... 14/6 14/-		
2 v 100 amps. ... 15/- 16/6		
4 v 40 amps. ... 13/11 15/11		
4 v 60 amps. ... 17/11 19/6		
4 v 80 amps. ... 22/6 23/6		
6 v 60 amps. ... 26/6 27/6		
6 v 80 amps. ... 33/- 35/-		
Made by Rotax, Radlocell, etc.		
ORMOND Rheostat ... 1/8		
Fixed Condensers, Ebonite Base. .001 to .0001 ... each 10d.		
.002 to .006 ... each 1/-		
<b>"MANSBRIDGE."</b>		
2 mid. ... 4/-		
1 mid. ... 3/3		
25 ... 2/8		
<b>VALVE HOLDERS.</b>		
Solid Rod ... 1/-		
Anti-cap ... 9/4d.		
Various ... 9d., 1/- 1/3		
All makes stocked.		
<b>High-Class E.T. BATTERIES.</b>		
All best possible quality.		
60 volt ... 5/11 6/11		
80 volt BBC ... 8/6		
36 volt BBC ... 5/11		
9 volt BBC ... 2/-		
Famous 66 "K" ... 6/8		
Eveready, 66 volts ... 12/6		
Ditto, 108 volts ... 20/-		
Flash Lamp, 4.5. Extra "K" ... doz. 4/6		
Eveready "Red" ... 7/6		

Above two Columns for Callers.

**K. RAYMOND**  
7, GRAPE STREET, Shaftesbury Avenue, W.C.2.  
(Full Address above.)

In replying to advertisers, use Order Form enclosed.



THE "ALL WAVELENGTHS"  
NEAT AND COMPACT  
CRYSTAL SET!

THIS IS THE SELECTIVE  
CRYSTAL  
SET

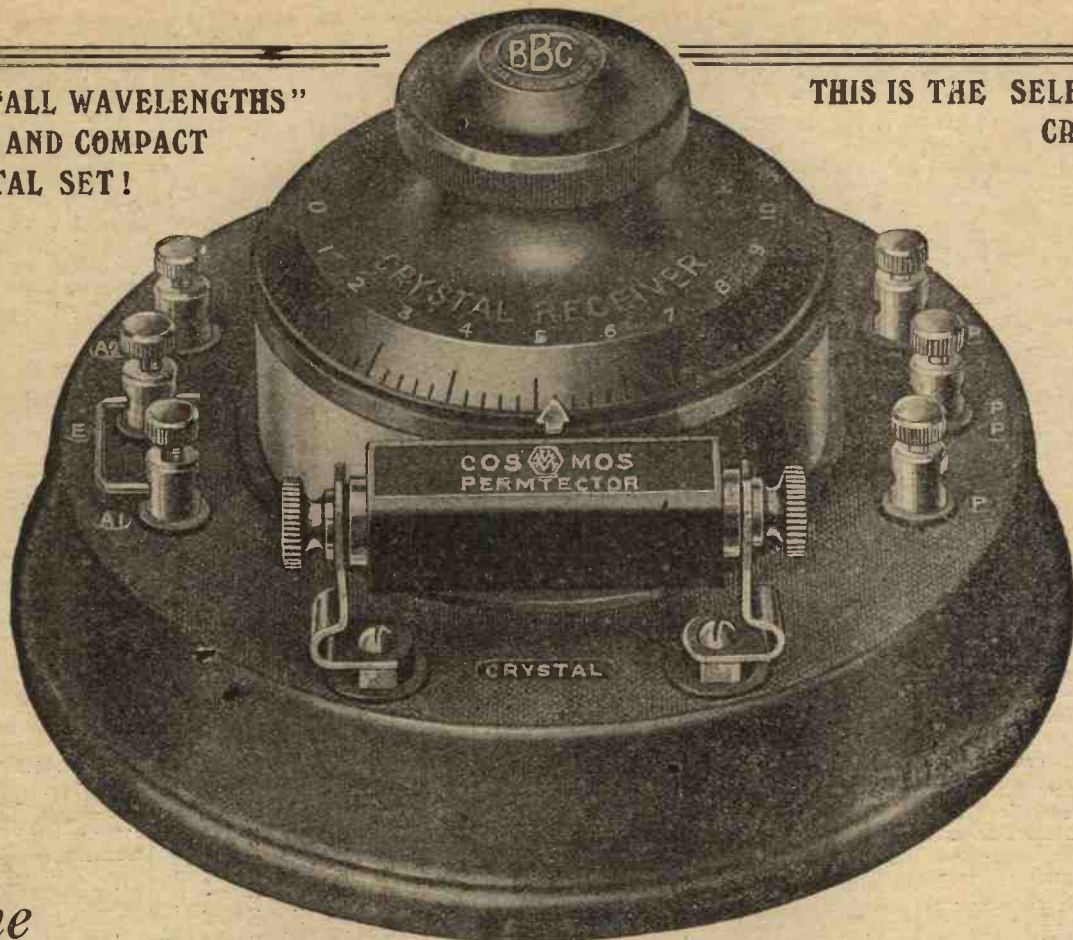

The

# COSMOS CRYSTAL SET

The illustration shows the  
"Cosmos" Crystal Set fitted  
with the "Cosmos-Permtector"



The  
Mark of  
Efficiency.

A NEW type of Crystal Set specially designed for use in connection with the new Daventry High Power Station but also suitable for ordinary B.B.C. reception. It embodies many **DISTINCTIVE FEATURES**. The circuit is arranged for three tappings which can be made at will, to either of the Plug-in Coils used, by the simple movement of a three-way plug, which connects the Crystal and 'phones across the requisite portion of the Inductance, thus giving a high degree of selectivity. One of these coils is for the ordinary B.B.C. Wave-Band (300-650 metres), and the other for the **High-Power Station** (1200-3000 metres). The coils are concealed in the base of the set and are easily plugged-in and changed in a second. **Tuning** is effected by a variable condenser; and two Aerial terminals, with a small fixed condenser, accommodate aerials of widely varying capacities. The **Detector** is either a covered **Cat's Whisker Type** or the "Cosmos-Permtector" and can be fixed or detached in a moment. The set can be used on a **Table** or on the **Wall**. In the latter case the **Headphones** can be hung on the condenser knob, thus making a neat and compact arrangement. The "Cosmos" Crystal Set is manufactured by the Metropolitan-Vickers Electrical Co., Ltd., and distributed by:

**PRICES—**

"Cosmos" Crystal Set only, with enclosed Crystal detector and one Plug-in-Coil (either B.B.C. Band or Daventry).

**25/-**

As above, but with the "Cosmos-Permtector" (and one spare "Permtector").

**28/-**

Plug-in Coil (either B.B.C. Band or Daventry).

**4/6**

## METRO-VICK SUPPLIES, Ltd.

(Proprietors: - - Metropolitan-Vickers Electrical Company, Limited, 4, Central Buildings :: Westminster, S.W.1.)

Obtainable from most Wireless Dealers.



6 Y			6 Z		
6 YA			6 ZA		
6 YB			6 ZB		
6 YC			6 ZC		
6 YD			6 ZD		
6 YE			6 ZE		
6 YF	C. P. ALLINSON	... .. 7, Compayne Gardens, Harapstead, London, N.W.6.	6 ZF		
6 YG	F. GOFF	... .. 102, Woodside Road, Bowes Park, N.22.	6 ZG		
6 YH	R. J. T. MORTON	... .. 14, Woodside Road, Kingston-on-Thames.	6 ZH		
6 YI			6 ZI		
6 YJ			6 ZJ		
6 YK			6 ZK		
6 YL			6 ZL		
6 YM			6 ZM		
6 YN	BRISTOL RADIO SOCIETY (Transmitter's Section)	32, Park Row, Bristol.	6 ZN		
6 YO	BRITISH RADIO SOCIETY (Portable)	32, Park Row, Bristol.	6 ZO		
6 YP			6 ZP		
6 YQ			6 ZQ		
6 YR	W. HARTLEY	... .. 3, Spring Bank, Follifoot, Nr. Harrogate, Yorks.	6 ZR		
6 YS	C. PROSEER	... .. Pleasant Harbour, East Aberthaw, Nr. Cardiff.	6 ZS		
6 YT			6 ZT		
6 YU			6 ZU		
6 YV			6 ZV		
6 YW			6 ZW		
6 YX			6 ZX	H. FIELD	... .. Baggrave Hall, Leicestershire.
6 YY			6 ZY		
6 YZ			6 ZZ		

THE DAVENTRY STATION.

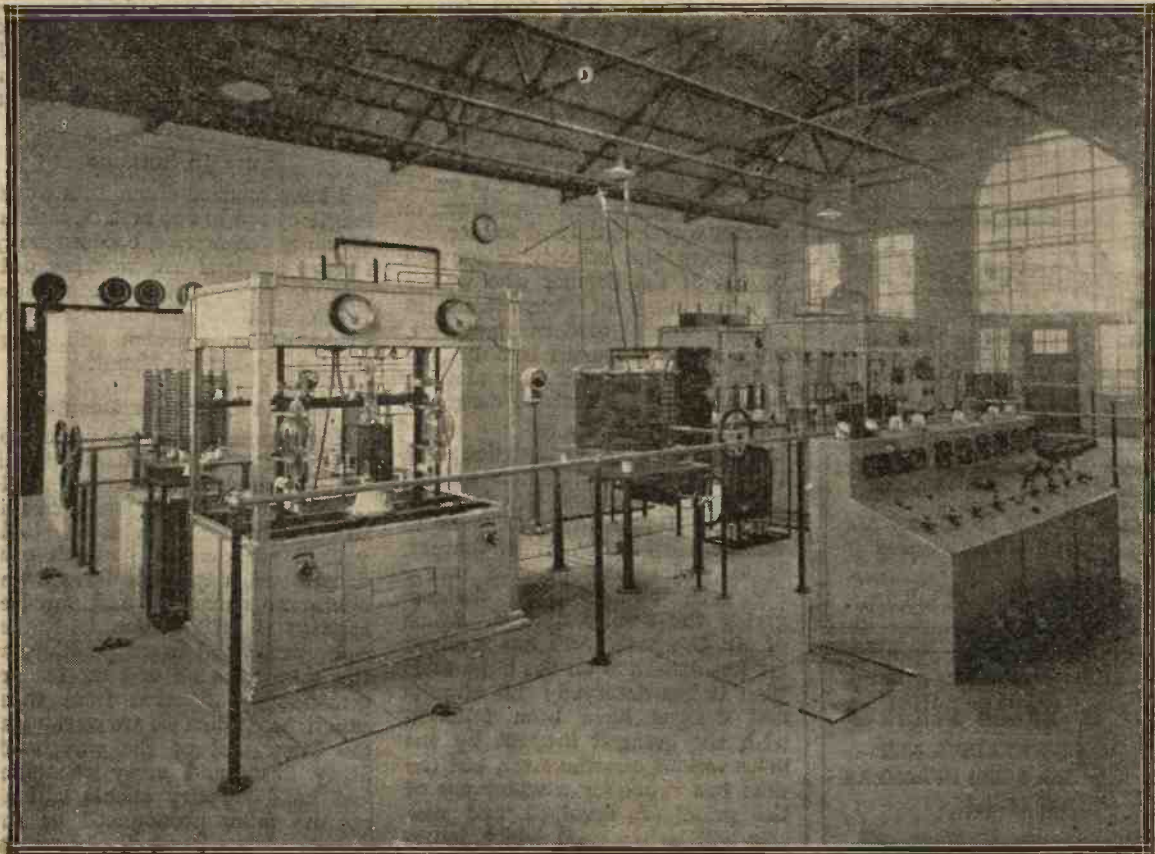

The opening of the new high-power station at Daventry, which took place on July 27, marks another step forward in the improvement of the existing system. This station has been erected in furtherance of the policy of the B.B.C. in aiming at programmes for crystal users throughout the greater part of the country, and alternative programmes for those in possession of more powerful receiving apparatus. A general view of the transmitting room is seen above. On the right of the photograph is the main control panel.



**SM**  
**SUPER PARTS**



**SILVER MARSHALL**  
210 and 211 transformers are known as the finest intermediate transformers ever produced. They were an important feature of the receiver built entirely of S-M Parts that won the grand sweepstake prize at the recent American Radio Show. They are also used by experts in the new Super-Autodyne, Laboratory and All-Wave Super-Heterodyne Receivers.

S-M Kit, consisting of two 210 and one 211, together with one 101 Oscillator Coupler, List Price, £6 18s. 9d.

Send for reprints of articles and our 36pp. Radio Catalogue, enclosing 6d. in stamps to cover cost of postage.

R. A. ROTHERMEL, LTD.,  
24-26, Maddox Street,  
London, W. 1.  
Telephone: Mayfair 513.

**Cabinets you want!**  
*for Radio Perfection*

**PICKETTS**—are used for Finest Sets.  
ESTIMATES PER RETURN.

Send for Cabinet List, Free.

**PICKETTS CABINET (M.W.) WORKS,**  
BEXLEY HEATH, S.E.

PATENTS, DESIGNS AND TRADE MARKS

**J.S. Withers & Spooner,**  
Chartered Patent Agents

Staple House,  
51 & 52 Chancery Lane,  
London, W.C.

Tel. "Improvably,"  
Holb. London.  
Tel. 480 Holborn



**REPAIRS**

TO HEADPHONES  
TO LOUD SPEAKERS  
TO COILS

Rewound to any Resistance and made equal to new. Price quoted on receipt of instruments.  
Prompt Delivery.

**THE VARLEY MAGNET CO.**  
(Dept. M), WOOLWICH, S.E.18

Established 26 years.

Phone: Woolwich 888.

(Continued from page 824.)

It is not my desire to indicate in advance the nature of the extremely valuable information which Mr. Percy W. Harris has brought from America. The data which he possesses are of extraordinary value, and undoubtedly indicate that, as regards selectivity, British designs are, in the main, a long way behind American models.

**Public Desire**

This, however, is not due to the fault of British designers, but is very largely due to the fact that the wireless public desires a set which will receive 5XX and also the shorter wave stations. In the United States the wavelength band does not include a long-wave station, and as a result sets can be designed much more efficiently and in such a manner that greater selectivity can be obtained. This selectivity, as a matter of fact, has been such a vital problem, in view of the very large number of broadcasting stations in the United States, that technical development has been absolutely compulsory.

**Future Tendencies**

The B.B.C. station 5XX is intended to be chiefly a crystal user's station, and there is going to be a distinct tendency on the part of radio designers in this country to ignore this station altogether in order to get very much better results on the shorter wavelengths and so increase the range and selectivity for the benefit of the listener who wishes a wide range of programmes in almost every modern language. Such an achievement is only possible, in my opinion, by altering our general standards of design.

**A Tribute**

It is only fair to mention here that one or two designers in this country have realised this fact, the principal Radio Press designer in this field being Mr. A. D. Cowper, M.Sc., who has evolved many ingenious circuits and designs giving the results desired. Much of Mr. Cowper's work has received far less attention on the large scale than it has deserved; his circuits and designs have been followed with the greatest interest by the more serious experimenter, but the time has come for a wider use of the principles involved, and new sets will be designed which incorporate many of the principles which have already been enunciated in this country.

**British Designers not behind American**

From my own knowledge, I regard British designers as in no

way behind those of America, and the greatest handicap to British designers has been the existence of 5XX. We propose, however, to give special attention to the 200 to 600 metres waveband (1499 to 500 kc.), and to design a number of sets for this waveband, ignoring the high-power station. Obviously, these changes cannot be carried out at once, nor will the set of medium efficiency which will receive stations of all wavelengths disappear. Nevertheless, as the merits of the specially designed sets are appreciated, greater popularity of their usefulness will show itself.

Manufacturers, needless to say, will have to adjust their ideas somewhat to the new line of development, but this will be entirely to their own benefit, as it will involve the production of new types of components, especially designed for this purpose, while not rendering obsolete existing types. Our Elstree laboratories will give any assistance in this direction required, although my experience of British manufacturers is that their ingenuity of design and soundness of construction will ensure the required article when they see that there is to be a demand for it.

**Foreign Stations**

I have referred above to a wavelength of 200 to 600 metres, instead of 300 to 500 metres, because many foreign stations are working outside the ordinary waveband of the British stations, and sets will have to be designed which will cover this particular waveband.

**Effect on Receiver Designs**

The extension of the waveband to cover 200 to 600 metres will still enable a suitably designed single coil to tune over the whole of this wavelength range with a single variable condenser. Such condensers will require to have a low minimum capacity, and low-loss condensers will undoubtedly become more and more popular, as the conditions on 200 metres are considerably different from those experienced when we are working at the other end of the waveband. Stray fields and stray capacities and hand-capacity effects will all become more pronounced as the waveband is extended, and as designs are altered this will have to be borne in mind. Vernier arrangements will, I venture to say, become a matter of course, and both earth and aerials will probably require some alteration in their design.



**Fixed Coils or Plug-in Coils**

If we are to cover a waveband of 200 metres to 600 metres, we can do this readily with a single high efficiency coil which will replace the plug-in variety. I do not for a moment suggest that the plug-in coil will disappear. I think, however, that its efficiency will be materially increased by various means which, while not generally carried out, are appreciated by those who have carried out accurate measurements of the efficiencies of coils. The plug-in coil is the solution of the multiple wavelength range set, but even here improvements are possible in the design of the coils and their holders. In the case of the 200 metres to 600 metres set, however, a special coil will be built into the receiver and the plug-in coil will not be used. In the case of aerial tuning, varying sizes of plug-in coils are usually recommended on account of the variations in aerial capacity. In the case, however, of the fixed waveband receiver, this trouble will probably not be overcome by the use of tapped coils but by means of "aperiodic" aerial coupling or devices of a similar character.

**The Oscillation Nuisance**

The oscillation nuisance must be considered in relation to future radio developments. The oscillation trouble in this country is due, of course, to the extensive use of reaction and the violent endeavours on the part of single valve users to get distant stations. While the desire to receive distance is very commendable, yet the average listener makes his set oscillate in order to pick up the distant carrier wave. Those who oscillate when receiving their local station are the worst offenders, but this trouble can be partially overcome by educating those whose experience in these matters is small.

**H.F. Stages**

The use of two stages of high-frequency amplification and the extended use of neutrodyne circuits will result in a very great decrease in the oscillation trouble. Even the single valve user will, by altering the technical design of his receiver, cause far less trouble than formerly. "Floppy" reaction is the cause of much oscillation. As the reaction is tightened the valve suddenly goes into self-oscillation, and if the reaction coil is removed the self-oscillation continues while the coil is being moved away, whereas, of course, suitable design can ensure that the moment the reaction coil is moved slightly

further away, self-oscillation immediately stops. Even by this simple procedure, the amount of time during which oscillation is going on can be reduced to one-tenth of the normal period. These points in design will receive attention at our laboratories, and already a satisfactory solution of this problem is available.

**Increasing Selectivity**

Already I have indicated that new methods of obtaining selectivity and general improvement in design will be obtained by confining the wavelength range of a set, instead of making all sets suitable for any wavelength up to, say, 3,000 metres (100 kc.).

Selectivity, however, does not merely depend upon circuit arrangement or on the more obvious methods of building a circuit with components. Selectivity may either be obtained at the very beginning of the set or it may be obtained in the intermediate stages of high-frequency amplification, for example. Sometimes selectivity is obtained in both cases.

**"Pick-up" Effects**

The lack of selectivity in many sets has been due to the lack of appreciation of some of the more subtle reasons for the absence of sharp tuning. The unscientific use of reaction and the unscientific designing of circuits, as regards the elimination of losses, is responsible to a certain extent. There is also the important factor due to certain parts of the receiver picking up signals direct instead of via the aerial. A sensitive receiver will pick up a local station up to 10 or 20 miles without any aerial or earth at all. In such a case selective aerial arrangements are only a partial solution of the selectivity problem. Intermediate stages will readily pick up the signals, and any selectivity obtained at the input side of the circuit will be largely masked by interference occurring at later stages of the circuit.

Stray fields of various kinds are also responsible for a good deal of interference, and all these factors will be taken into consideration in the immediate future.

**Improving Signal Strength**

The question of improving strength is, of course, broadly covered in this article, but there are certain lines of development which will undoubtedly give increased strength. Hitherto signal strength has in general been lost in the arrangement of selective circuits, but we are now on the threshold

**Quality RADIO COMPONENTS.**

Profusely illustrated thirty-page CATALOGUE just out. If your dealer cannot give you one, send us a card with his name and address to receive it direct FREE and POST FREE.

**STANDARD COIL-HOLDERS**  
Reduced Prices.



2-way, 3/9, postage 3d.  
3-way, 5/6, ,, 4d.

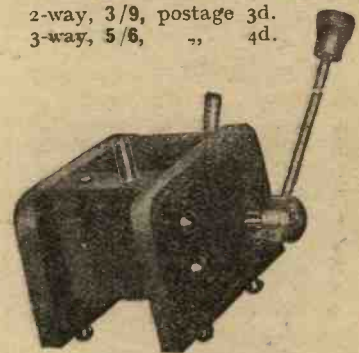

With Angular Handle,  
2-way, 4/-, postage 3d.  
3-way, 6/-, ,, 4d.

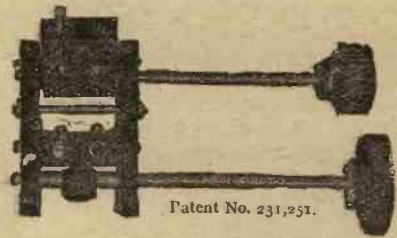

Patent No. 231,251.

**Quality RADIO CAM-VERNIER COIL HOLDER**

Price 9/-, on base 1/- extra. With Reaction Reverse and Shorting Switch incorporated, 12/6. Postage 4d.

**GOSWELL ENGINEERING CO., LTD.,**

95, 96, 97, & 98, White Lion St., LONDON, N.1.

Liberal Trade Terms.



of a selective era where loss in signal strength is negligible. In fact, in nearly all cases, the methods adopted to gain greater selectivity also give greater signal strength, e.g., elimination of the various losses in the circuit.

**Valve Design**

The question of valve design is one which is rather outside the scope of the Radio Press laboratories. Uniformity of valves in certain classes is, however, desirable, and there is no doubt that the ordinary general purpose valve will tend to give place to valves designed specially for carrying out certain functions. Even the general purpose valve itself is capable of improvement and development. Apart from the V.24 and the Myers valves, there has been little effort made to reduce the inter-electrode capacity effects, and in all probability valves will be produced in which all unnecessary capacity is reduced to a minimum.

**H.F. Transformers**

In my belief, the ordinary high-frequency transformer of modern design will undergo a radical change in construction. Those who have carried out extensive private experimental work on transformer design and compared their results with those obtainable with the standard small transformer now made by a considerable number of firms, will have realised that here is a great field for development. There has been a tendency for commercial concerns to rest on their laurels, with the result that intervalve high-frequency transformers are no better to-day than they were three years ago. Here again, the reason is probably not merely a question of apathy on the part of manufacturers, but in part the tendency in radio design. The small compact H.F. transformer now commonly used has almost invariably been placed in valve holders mounted on the front of a panel in full view of the listener. Consequently, the transformers had to be of attractive shape and of small size. This necessitates the windings being in slots, the coils

being surrounded by a mass of solid dielectric, and wound in such a manner that there is a large amount of self-capacity. The trend in wireless design is now to have everything but the controls, and perhaps

or by the construction of the transformer unit itself. One firm already is marketing a high-frequency transformer which possesses distinct merits, but which could be still further improved and made less bulky.

**L.F. Transformers**

As regards low-frequency transformers, there is room for all-round improvement in these. A certain iron-core transformer has been placed on the market which, as regards the cutting down of distortion, is undoubtedly in the front rank. All these advantages, however, have been outweighed by the fact that there have been a very large number of breakdowns within a short period after purchase, and this is a fault which will have to be overcome.

It is not unlikely that the highest grade of iron-core transformer will be a considerable expense. There is, however, no doubt that many transformers of excellent design will be placed on the market at cheaper prices, and there are, in fact, a number already in existence, which, while giving excellent signal strength also give a very fair degree of purity of reproduction of speech and music.

**The Single Valve User**

As regards the single valve user, he will benefit by modern improvements just as much as those who use a number of valves. Not only is there still a great field for super-regenerative work using a single valve, but the proper use of ordinary reaction has by no means reached a stage of finality. I have indicated elsewhere in the article that "getting close to the reaction point" is almost impossible in a large number of single valve receivers, owing to the valve oscillating long before the full useful reaction effect is obtained. In other words, the set bursts into oscillation before a fine adjustment of reaction has been made possible.

**Sensitivity of Loud-speakers and Telephone Receivers.**

Although it is not generally realised, the telephone receiver of to-day is by no means a standard article. Different makers' products vary a great deal as regards their sensitiveness. The sensitiveness of the modern telephone receiver is not merely a matter of price but also of design, and some striking figures could be given which would show the difference between different manufacturers' products. A general increasing of the standard of efficiency is probable, while a loss of purity of reproduction must on no account be allowed to take

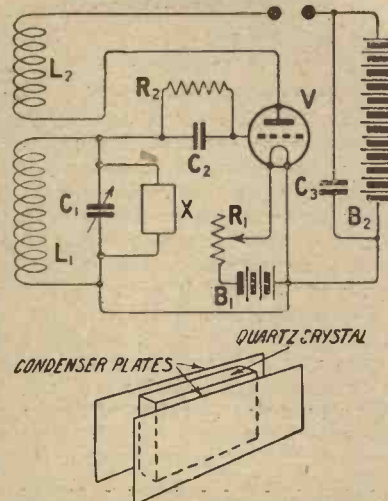
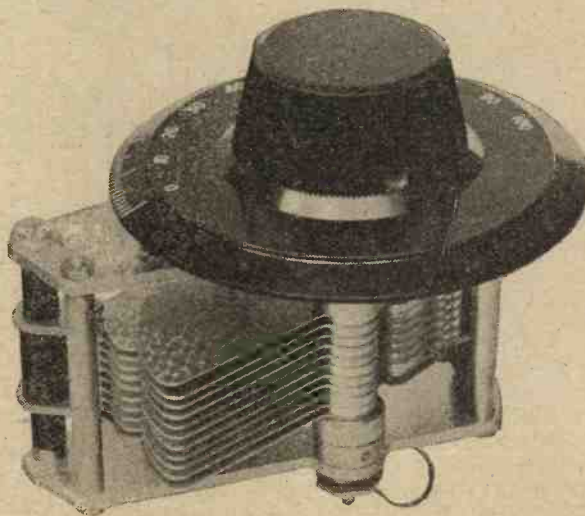

Fig. 6.—The circuit of a quartz crystal wavemeter. The two black dots will normally be shorted. The arrangement of the crystal is also shown.

the terminals, behind the panel, mounted usually on a baseboard at right angles to the front panel. The aesthetic appearance of the transformers is now no longer a consideration, and they can be made much larger and designed on more efficient lines. With the greatest confidence I predict that a new class of high-frequency transformer will be almost immediately evolved. Such transformers may also be arranged so as to avoid interaction. This may be accomplished either by the method of mounting



A low-loss condenser of recent introduction. Note the large dial.



place. It is possible, for example, to get telephone receivers which will give a general improvement in signal strength at the expense of purity of reproduction. In many cases it is better to have telephone receivers which give really pure reproduction, even if they are not quite so sensitive, but of course both qualities should be aimed at, and at our new laboratories elaborate arrangements are being made for testing the purity of reproduction of telephones, loudspeakers, transformers, etc., etc.

#### Loudness of Output

Loudspeakers are more important than telephones, and it is surprising the variation between different loudspeakers as regards the loudness of the output. If the reader had half-a-dozen of different makes he would be astonished at the difference in loudness of the speech and music received on his set. Some loudspeakers give double the volume of others of similar price. Here, again, it must be borne in mind that it is a fairly simple matter to design a loudspeaker which will give loud signals at the expense of purity. A loudspeaker could be designed to receive a certain note, and its output, as regards sound, would be very high. For other notes, however, the "loudness" of the loudspeaker would be poor. By making the loudspeaker respond equally to all notes so as to give a natural reproduction effect, it is often necessary to sacrifice the loudness of signals.

#### Loudspeakers and the Number of Valves Used

Obviously, however, preference should be given to the loudspeaker which gives signals of good strength with weak currents, provided distortion is absent; in this case fewer valves, obviously, are necessary, and in my opinion one stage of low frequency amplification should be enough to work a loudspeaker for use in a room of normal size. The reduction in the number of stages of low frequency amplification, moreover, decreases the tendency towards distortion in the receiving circuit.

#### Reducing the Number of Valves

Reduction in the number of valves can be obtained by the more efficient use of principles already known, or by evolving new princi-

ples of reception. Super-regenerative circuits will, in my opinion, return again, although I am fully aware that experimenters generally regard them as obsolete. I have, however, data in my hands which will entirely dispel this idea.

#### Reflex Circuits

Reflex circuits will, in my view, continue to be popular, although until certain difficulties have been overcome it is not likely that they will become strikingly popular except in the case of one- and two-, and perhaps, three-valve sets. In these latter cases further developments are to be expected and an improved two-valve reflex set has been evolved by the Radio Press laboratories on lines indicated by Mr. John Scott-Taggart, F.Inst.P., A.M.I.E.E. This reflex set is a modern form of the ST.100 receiver which has probably achieved greater popularity than any

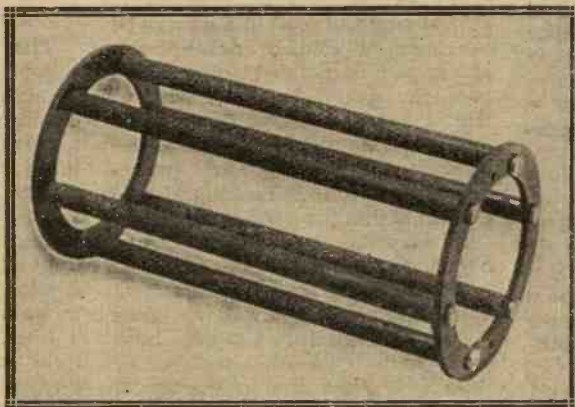

A good example of modern practice is the common use of low-loss coils wound upon formers of the type shown here.

single set yet designed. Such disadvantages as the ST.100 has have been overcome and a set giving greater signal strength, greater selectivity and greater range has been evolved.

This new receiver is to be described in the first issue of *Wireless*, which will be published on September 15th.

#### Purity of Reception

As regards purity of reception, I have not the slightest doubt that more and more attention will be given to this aspect of broadcasting which is essential if a wider popularity is to be ensured. In the old days of spark and C.W. reception the question of distortion was never considered. As a matter of fact, in order to get greater signal strength, note tuning and other devices were employed in order to

increase range and develop louder signals. For example, telephone receivers were designed to respond to a frequency of about 1,000, and the signal strength fell off when other frequencies than this were received. In the case of broadcasting, however, the notes received vary over a very wide scale and unless telephones and loudspeakers are specially designed, distortion will be apparent.

#### Natural Effect

There has been considerable improvement during the last year as regards purity of reception, and home constructors and experimenters generally are adopting methods to overcome distortion, while designers of wireless sets are even more concerned with this problem.

Manufacturers of loud-speakers are, however, some distance off the ideal. There is still room for loudspeakers which will give a truly natural effect, although, of course, a perfect loudspeaker is no use unless the receiver is also near perfection.

#### Possible Developments in Components

Components are at present undergoing radical changes, and not only will new components be introduced, but existing ones will be developed.

#### Low-Loss

The forthcoming year will see big strides in the development of low-loss components. The words "low loss" will be the slogan of many firms, and in some cases quite fallacious claims will probably be made because the low-loss problem is not nearly as obvious as it would appear to be. The losses in certain parts of a receiver are so low with regard to other parts that a complete alteration in the construction may make no appreciable difference to the final results. Losses should therefore be looked for at the right points in the circuit.

Variable condensers, of course, have already undergone considerable change, and this change will become more important in view of my remarks regarding the tendency to use fixed coils and to work on a waveband, the lower limit of which will be in the neighbourhood of 200 metres, formerly considered an ultra-short wavelength, now commonly used for ordinary broadcasting by some stations outside this country.



**Condensers**

There is room, in certain directions, for mechanical improvements in condensers, which, in some cases, are distinctly faulty. I refer particularly to the movement of the spindle in its bearings, or speaking generally, the smooth movement of the dial. Many condensers on the market to-day move jerkily, which makes accurate tuning very difficult, especially on the short-wave lengths. Manufacturers have already got down to this problem, and some have produced excellent models using ball-bearing arrangements, although I do not wish to imply that the use of ball bearings is the only solution. Vernier effects will become more and more important, and several solutions have been offered, many of which are exceedingly ingenious and effective. Scales of 360 degrees are already in use, and different forms of gearing are being employed although great mechanical care is required to avoid back-lash effects. Vernier dials applied to ordinary condensers are also likely to be popular, but a vernier dial applied to a badly rotating spindle is not a satisfactory combination.

**Moving Plates**

I think it important that there should be uniformity in condenser rotation. Some condensers increase their capacity, while others decrease in capacity as the knob is turned to the right. Some convention should be arrived at.

Bigger dials are desirable, and although a scale of 100 degrees is suitable for, say, a 3-in. dial, yet 180 degrees could be used on 4-in. dials, since a mark could be made for every degree on the larger dials, whereas on smaller dials 180 degrees is not suitable because much confusion arises owing to the fact that a mark is made at every two degrees.

**Shock-absorbing Valve Holders**

The increasing use of dull emitter valves necessitates the use of some scheme for lessening vibration effects, and there are one or two makes of anti-vibration valve holders. Some of these are by no means mechanically perfect. One fault which is sometimes experienced is that softening of the insulating material occurs whenever a soldering iron is brought near one of the essential points.

**A Note to the Trade**

There are a large number of criticisms and suggestions which might be made which do not concern, at this stage, the reader of a

journal such as MODERN WIRELESS, but which are more appropriately made in a trade paper, and I propose to go into details in the new Radio Press trade journal, the *Wireless Dealer and Manufacturer*, which will enable manufacturers to keep in touch with the views held by the Radio Press.

**Use of Quartz Crystal in Wavemeters.**

One of the most interesting developments in wireless in recent years has been that quartz or rock crystal has very definite effects at one frequency depending on the size of the crystal. A small plate of quartz looks just like a small piece of glass, and naturally so, for quartz or silica is the main constituent of glass, though in another form. Some forms of ordinary sea sand are almost pure quartz, and the type of sand used in the manufacture of glass is called silver sand. This small plate of quartz, prepared in a special way and used in a way to be described, responds to one frequency in a most remarkable manner. Suppose the quartz is about half an inch long, and about one-twelfth inch thick, it will respond to a frequency of about 300 kc. (wavelength of 1000 m.). The remarkable feature is that it responds to 300kc., and to a very narrow band near this frequency, not more than about 30 cycles on either side. So here we have the most simple and yet most selective device that has ever been discovered: One other remarkable feature is that this frequency is scarcely affected by ordinary conditions at all. Temperature variations of an ordinary room do not vary the frequency by more than 3 or 4 cycles.

**Methods of Using**

With a crystal correctly prepared—and the method of preparation will be described shortly—the following effect is observed. Connect a simple oscillating valve circuit in the ordinary way. Arrange a small condenser of two parallel faces with the plates standing vertically, the distance apart being just greater than the thickness of the quartz. Place the quartz plate loosely in this condenser holder and join the condenser in parallel with the grid tuning condenser of the oscillating valve circuit. A pair of telephones is included in the anode circuit. Vary the grid tuning condenser and it will be observed that at a certain point there is a click in the telephones. This occurs at the frequency which is the frequency of the crystal. If the condenser has a wide scale, it will be

found that on a rising frequency a slightly different position of the click is obtained from that on a falling frequency. Midway between these two readings gives the actual frequency of the crystal. The distance apart of these two points depends on the violence of the oscillation in the valve circuit, and this distance can be cut down by using less power (see Fig. 6.).

**Accurate Calibration**

Supposing that the oscillating circuit is used as a wavemeter, the crystal gives one point of calibration which is very accurate indeed. By having a series of crystals of different lengths it is possible to obtain a number of very accurately calibrated points on the wavemeter.

It is possible to purchase crystals from Messrs. Adam Hilger with frequencies marked on them and if necessary having an N.P.L. check.

**The Piezo-Electric Effect**

The reason for this remarkable effect is because of a property of crystals known as the Piezo-Electric effect. With certain crystals, if a pressure is applied to one pair of faces, or along one axis, an electric charge is obtained on one face perpendicular to another axis. Vice versa, if a difference of potential is applied to one pair of faces, the crystal extends or contracts along an axis at right angles.

Now, a plate of crystal, or of any rigid material, has a definite frequency of vibration mechanically. This is well known from the musical instrument called a Dulcimer, where different notes are produced by having plates of different lengths, the shorter the plate, the higher the note; a hammer being employed to strike the different plates.

**Explanatory Remarks**

The quartz crystal plate we are considering, of about half an inch in length, has a frequency of about 300,000 cycles, which is much higher than the ear can appreciate. Thus, if we apply an alternating potential across the thickness of the plate at a frequency of 300,000 the plate is made to vibrate along its length. The vibration of this plate cannot be kept going with no expense of energy, and thus there is absorption of electrical energy from the circuit to supply the mechanical energy. It is this absorption of energy from the oscillating circuit which counts for the clicks in the telephones.

Here we have a new form of transformation of energy from electrical to mechanical, at a very definite frequency, and there will be many







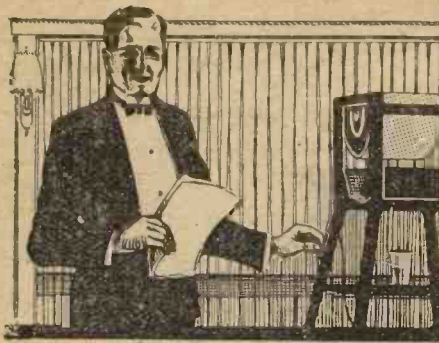

# “The Wireless Dealer”

The Radio Trade Paper of Distinction.

**A** FORTNIGHT after publication of this issue of MODERN WIRELESS there will appear the first number of *The Wireless Dealer*, a new monthly journal published by Radio Press, Ltd., and designed to circulate exclusively to the trade. In this magazine the unrivalled technical facilities—both in the way of staff contributors and laboratory facilities—will be placed at the disposal of the trade in solution of their problems. This alone would ensure the success of the new journal, but in addition a remarkable list of contributions from leading members of the trade will figure in each number.

### The Exhibition

The first issue will, of course, devote a considerable section to the Wireless Exhibition at the Albert Hall, and, naturally, *The Wireless Dealer* will contain all of those regular features which have come to be associated with a trade journal. It is, however, in the many new features that *The Wireless Dealer* will prove so distinctive, and, being a perfectly free and independent journal, it will not lack frankness in dealing with all aspects of the trade.

### Test Reports

The opening of the Radio Press testing laboratories under Major James

Robinson, D.Sc., Ph.D., F.Inst.P., at Elstree, will enable *The Wireless Dealer* to publish test reports on apparatus of a kind that have not hitherto been available either in this country or America. The wireless dealers throughout the country will thus be assured that by following the guidance of *The Wireless Dealer* they will be purchasing for re-sale to their customers components of the best quality on which they can rely implicitly. The manufacturer, on the other hand, will be able to refer to the test reports not only for his own guidance, but so as to be able to prove to the trade that his apparatus is sound both mechanically and electrically.

### Trade Readers

A certain proportion of our readers are engaged in the trade and will thus be greatly interested in the new journal. They should lose no time in arranging through their employers a subscription to be taken out. Would-be subscribers should communicate at once with Radio Press, Ltd., Sales Department, Bush House, London, W.C.

### Where to Order

*The Wireless Dealer* will not be sold to the general public, and is only obtainable by direct subscription to the publishers at Bush House, and not from bookstalls or newsagents.

## BACK AT WORK



Readers will be interested to know that Mr. Harris has returned from his visit to America, and is now preparing an interesting series of articles describing his impressions. An important article on American conditions appears in this issue.

\* \* \*

### ENVELOPE No. 4.

SIR,— If Mr. Harris could only see the crowd of several hundred people that listen when I put the loud-speaker out of the window, I am sure he would be highly gratified with the design of his “All-Concert de Luxe.”

I manage to get most of the stations, all the B.B.C. and some of the relay ones. America, too, on the loud-speaker from 11 till 2 o'clock during the winter without X's or fading.— Yours faithfully,

G. S. COUSINS.

Bury  
St. Edmund's



**A.J.S.**

"THE HALL MARK OF

RADIO PERFECTION"

# 'AS GOOD AS THEY LOOK'

## A.J.S. PEDESTAL CABINET RECEIVER

Represents the highest standard achieved in the design of wireless receiving sets. Each cabinet is a complete unit containing 4-valve Receiver, H.T. (Double Capacity) and L.T. Batteries. Special A.J.S. Loud Speaker to match cabinet, and all accessories. In Mahogany or Oak, £51 18 0.

## A.J.S. LOUD SPEAKER

Accurate proportions and non-resonant horn, giving correct acoustic properties and ensuring true reproduction. Utmost volume with complete absence of distortion. Price, with Metal Horn, beautifully grained in a variety of woods, and Electro-plated fittings, £4 15s. With Oak or Mahogany Horn and Electro-plated fittings, as illustrated, £5 16s.

For those who require a Receiver of highest efficiency in a handsome and beautifully finished Cabinet, there are no finer instruments than A.J.S.

Possessing all the qualities that distinguish really good reception, A.J.S. Receivers are particularly notable for long-distance work and simplicity of control.

The models illustrated can be obtained in Oak or Mahogany, and 2, 3, and 4-valve "Desk Type" models in polished Walnut. All models are supplied with a complete set of finest accessories ready for instant use

*A postcard will bring you Illustrated Catalogue and full particulars of the wide range of A.J.S. Components and instruments, including the 2- and 3-valve sets.*

## A.J.S. "UNITOP" CABINET RECEIVER

A handsome and portable cabinet containing A.J.S. 4-valve Receiver and representing the maximum of compact efficiency. Finest British workmanship and thorough finish throughout. Cabinets are obtainable in Oak, or Mahogany. Complete, ready for instant use, £19 18 0 (Without accessories, £24 10 0).

*Every A.J.S. 4-valve Receiver is furnished with the following accessories, ready for instant use:-*

Stand No. E37  
at the N.A.R.M.A.T  
Exhibition, Royal  
Albert Hall  
Phone: Kensington 9239

*Two capacity super giant H.T. Battery, Lucas A.J.S. moulded case, Accumulator of 6 V x 104 amp. capacity, 3 Mutual A.J.S. specially designed Valves 1 ditto Power Valve, 1 pair A.J.S. Phones, Full Aerial Equipment, Aerial and Earth Switch, Coil Holder and D. entry Coils 200/300.*



A. J. STEVENS & CO. (1914) LTD.

Wireless Call Sign: 5RI.

Telephone: Wolverhampton 1743-1752.

RADIO BRANCH, WOLVERHAMPTON

Telegrams: "Reception, Wolverhampton."

*In replying to advertisers, use Order Form enclosed.*



# Important Announcement!

ONE of the most decisive and beneficial steps ever taken in the history of British Wireless has been accomplished by a collaboration between the world-renowned manufacturers of Mullard Valves and Philips Glowlampworks Ltd., the famous lamp and valve makers in Holland.

This outstanding collaboration secures for the British Wireless Industry—

- (1) The stoppage of all imported foreign valves into Great Britain, Northern Ireland or the Irish Free State by Messrs. Philips, the largest exporters of Radio Valves to this country.

This will mean an immediate call for **INCREASED BRITISH PRODUCTION** to meet the demands of the home market, thus producing **MORE WORK FOR BRITISH LABOUR!**

- (2) The exclusive use in Great Britain by the Mullard Radio Valve Co. Ltd. of all Philips Patents and improved manufacturing processes relating to the specialised manufacture of Radio Valves.

This means that all Mullard Valves will be produced under the combined valuable Philips and Mullard Patents and will be manufactured in Great Britain, thereby providing an enormous increase in the employment of skilled and unskilled British Labour.

- (3) The use of all machinery designs of Messrs. Philips by the Mullard Co. in connection with the manufacture of Radio Valves. These designs are extremely valuable and are exclusive for use in England to the Mullard Co.

The advantage of the very latest designs in machinery cannot be overrated. The delicate and highly-skilled work of valve manufacture will be improved and increased by the use of this modern plant, and there will be

**AMPLE SUPPLIES OF MASTER VALVES FOR EVERYBODY.**

- (4) The combined efforts of both the Mullard and Philips technical experts to obtain from experiments and research in their extensive laboratories all radio valve developments from time to time.

This means that Mullard Valves will carry the superior advantages of thorough research and contain the most advanced designs for **PERFECT RADIO RECEPTION.**

This gift of service to the British Wireless Industry will consolidate and preserve the high standard in the productions of Great Britain and further the endeavour for the improved

**EXCELLENCE OF BRITISH BROADCASTING.**

The Radio Public of this country will be the first to recognise the wonderful advantages of this Master Collaboration particularly when it means

**MORE WORK FOR BRITISH LABOUR AND BETTER RADIO VALVES**

**Support British Endeavour and BUY BRITISH GOODS**

# Mullard

## THE MASTER VALVE



Advt. : The Mullard Wireless Service Co., Ltd., 45, Nightingale Lane, Balham, S.W.12



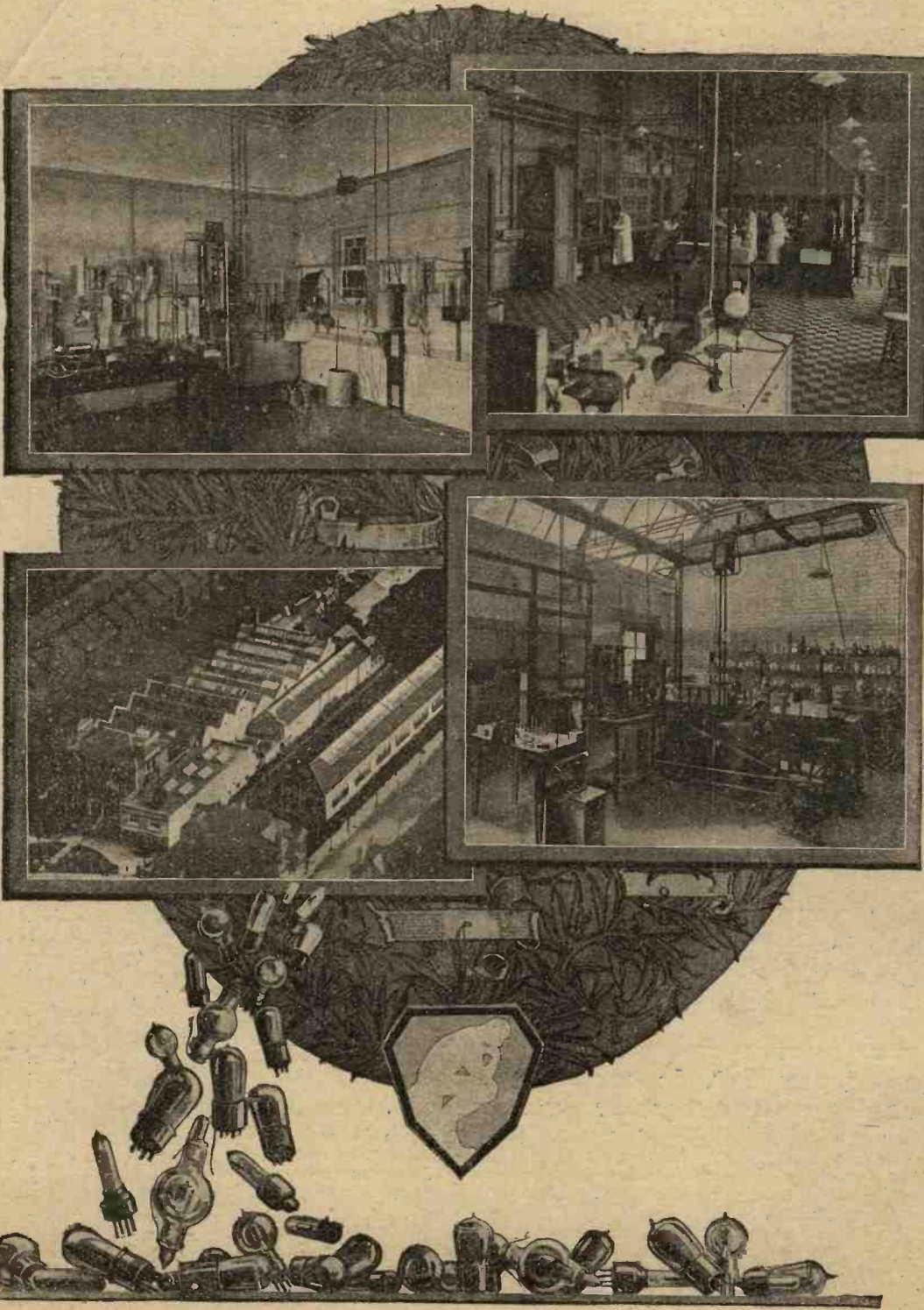

Advt. : The Mullard Wireless Service Co., Ltd., 45, Nightingale Lane, Balham, S.W.12.

In replying to advertisers, use Order Form enclosed.



**L**ISTENERS to Continental broadcasting will no doubt have noticed a considerable increase in the number of stations now regularly transmitting programmes, and they will have observed that in the majority of cases a wavelength of something between 200 (1499 kc.) and 600 metres (499.7 kc.) is being used, with the result that some stations are working on wavelengths so near together that good reception of either, in some districts, is impossible.

**Jamming**

This problem of jamming has become such a serious matter of late that it has been suggested that the wavelengths below 200 metres (1499 kc.) should be utilised, and it is quite possible that this suggestion will be carried out in the near future. When this time comes, those listeners who desire to receive the Continental transmission on the shorter waves will certainly need to re-design or at least modify their existing receivers in order that reception may be as efficient as on the normal wave-band.

It must be realised that losses in a wireless receiver increase as the wavelength in use is reduced.

In this connection, G. P. Kendall, B.Sc., writing in *Wireless Weekly*,

**Reducing Wavelength**

dated July 22nd, gave some valuable information regarding the amount of energy absorbed by a variable condenser in an oscillatory circuit; and in the August 5th issue of the same journal, under the title of "Inductance Design and Losses," A. D. Cowper, M.Sc., described the results of his experiments in the direction indicated.

**The Superheterodyne**

An essential part of the superheterodyne type of receiver is a local source of oscillations, and just how important a part is played by these oscillations was thoroughly explained in the July 22nd issue of *Wireless Weekly*, by J. H. Reyner, B.Sc., A.C.G.I., D.I.C., under the title—"The Importance of the Het. in the Superheterodyne."

**Selectivity**

In the minds of a great number of people, selectivity in a wireless

receiver is associated with intricate and numerous controls, only successfully adjusted by an experienced operator. This is a wrong idea. In the current issue of the *Wireless Constructor*, a three-valve set is described by A. V. D. Hort, B.A., which, whilst giving a marked degree of selectivity, retains a simplicity of control which will allow those who are not skilled in such matters to operate it successfully.

**Research in America**

Percy W. Harris, M.I.R.E., assistant editor of MODERN WIRELESS, returned a short while ago from an extended tour of the various wireless stations and research laboratories throughout the United States of America. He was enabled to visit many well-known places and to obtain a thorough insight into American progress and the methods used to overcome the many difficulties with which the wireless experimenter is faced.

In a series of articles entitled "What I saw in American Research Laboratories," Mr. Harris is giving much valuable information which every reader of *Wireless Weekly* will find fascinating reading from both the technical and non-technical standpoints.

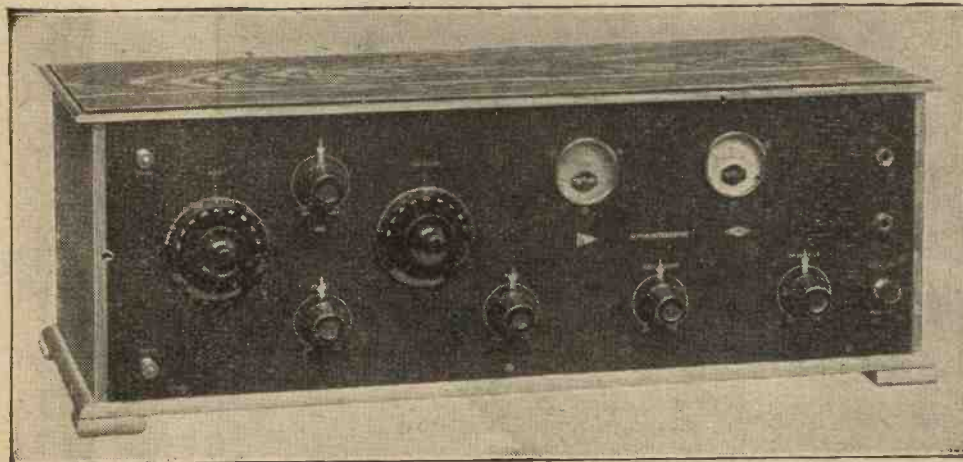

**A Keystone Super-Het. is not expensive —you can easily convert your present Set.**

**E**VERYONE knows that the Super-Heterodyne is the last word in Receivers. Users are frankly amazed at its wonderful selectivity—and its ability to pick up stations a thousand miles away on a small frame aerial is positively uncanny.

Many people think that the Super-Het. is beyond their reach, but that is because they have not studied the list of components required. We show here the full list of parts

required to build the Keystone Super-Het. illustrated above. For simplicity and economy this fine Set has no equal. Check it over carefully and see how many parts you can already use from your existing Receiver. You'll be pleasantly surprised to find how little stands between you and one of the finest Sets on the market. Full particulars of the Keystone Super-Het. what it is and what it will do, will be sent post free on receipt of a postcard.

**PETO-SCOTT Co., Ltd.**

77, CITY ROAD, E.C.1 (For all Mail Orders).  
Branches:—LONDON: 62, High Holborn, W.C.1;  
& 230, Wood St., Walthamstow. LIVERPOOL:  
4, Manchester St. PLYMOUTH: Nr Derry's Clock.  
P.S. 342A.

**These are the parts you need:—**

- 1 Keystone "A" type Transformer Kit (3 Intermediate Transformers and 1 Tuning Filter, all matched) .. 6 0 0
- 1 Plug-in Oscillator Coupler and base .. 19 6
- 1 Max-Amp L. F. Transformer .. 19 6
- 2 Peto-Scott Square Law Condensers with Vernier. Each 4005 mfd. .... 1 2 0
- 4 Kilohm rheostat .. 1 2 0
- 1 Potentiometer 400 ohms .. 1 6 9
- 3 Burnolopt Valve Holders (Note that four are already incorporated in the Keystone Transformer Kit) .. 15 0
- 3 F.C.C. Condensers each 1mfd with leaks .. 11 6
- 2 Dubilier Grid Condensers each 905 mfd. .... 11 0
- 3 Dubilier fixed Condensers each 905 mfd. .... 9 0
- 1 Micrometer Condenser .. 5 6
- 1 Lissen Push-pull switch .. 4 0
- 2 Jacks and two plugs .. 8 6
- 11 Large Terminals .. 2 9
- Wire, solder platform and soldering tags .. 1 6
- 1 Voltmeter .. 10 6
- 1 Nickel plated rotary switch for above .. 2 6
- 1 Polished Mahogany Cabinet with baseboard .. 2 4 0
- 1 Red Triangle Ebonite Panel 24 in. x 8 in. x 1/4 in. drilled and engraved .. 1 5 0
- 1 Terminal strip fully engraved .. 2 9
- 1 Keystone Constructional chart with full set of blue prints and all necessary particulars .. 3 0

**SPECIAL NOTE:** A licence from the Western Electric Co., Ltd., is required to build this Receiver. This can be obtained from them direct or we will obtain it for customers on receipt of the fee of 30s. Should the above parts be ordered at one time with the panel a royalty of 12/6 per valve holder is payable to the Marconi Co., Ltd., and should be remitted with the order.





(Strictly Copyright.)

All Hours of Transmissions reduced to British Summer Time.

Ref. No.	B. S. T.	Name of Station.	Call Sign and Wavelength.	Situation.	Nature of Transmission.	Closing Time or Approx. Duration.	Approx. Power used.
<b>WEEK DAYS.</b>							
	a.m.						
1	5.45	Hamburg	— 395 m.	Germany	Time Signal, Weather Report	5 mins.	1.5 Kw.
2	7.40	Eiffel Tower	FL 2650 m.	Paris	Weather Forecast	5 mins.	5 Kw.
9	7.55	Vas Diaz	PCFF 1950 m	Amsterdam	Stocks, Shares and News	10 mins.	2 Kw.
4	8.05	Lausanne	HB2 850 m.	Switzerland	Weather Report	5 mins.	300 Watts.
211	9.0	Radio-Wien	— 530 m.	Austria	Market Prices	10 mins.	1.5 Kw.
238	9.55	Vaz Diaz	PCFF 1950 m	Amsterdam	Time Signal	3 mins.	2 Kw.
8	10.23	Eiffel Tower	FL 2650 m.	Paris	Time Signal in G.M.T. (Spark)	3 mins.	60 Kw.
10	11.0	Eiffel Tower	FL 2650 m.	Paris	Time Signal in Greenwich Side-real Time (Spark)	5 mins.	60 Kw.
180	11.15	Breslau	— 418 m.	Silesia	Weather Report—Exchange	10 mins.	1.5 Kw.
260	11.40	Hilversum	NSF 1050 m.	Holland	Political News	10 mins.	5 Kw.
13	11.44	Eiffel Tower	FL 2650 m.	Paris	Time Signal in G.M.T. (Spark)	3 mins.	60 Kw.
14	11.55	Eiffel Tower	FL 2650 m.	Paris	Fish Market Quotations, Cotton Exchange (Monday excepted)	10 mins.	5 Kw.
15	11.55	Frankfurt	— 470 m.	Frankfurt	Time Signal in C.E.T. (Spoken), followed by News	5 mins.	1.5 Kw.
	Noon.						
182	12.0	Leipzig	— 454 m.	Germany	Concert	12.50 p.m.	1.5 Kw.
184	12.0	Zurich	— 515 m.	Switzerland	Weather Report	5 mins.	500 Watts.
261	12.0	Helsingfors	— 370 m.	Finland	Weather Report	5 mins.	1 Kw.
	p.m.						
20	12.15	Voxhaus	— 505 m.	Berlin	Exchange Opening Prices	5 mins.	4.5 Kw.
30	12.30	Stockholm	SASA 427 m.	Sweden	Weather Forecast, followed by Exch. and Time Sig. from Nauen	1 p.m.	1 Kw.
249	12.30	Breslau	— 418 m.	Silesia	Morning Concert	1.25 p.m.	1.5 Kw.
32	12.30	Radio-Paris	SFR 1750 m.	Clichy	Concert, followed by News	2 p.m.	8 Kw.
239	12.35	Royal Dutch Meteorological Inst.	— 1100 m.	Utrecht (De Bilt)	Night Frost Reports	10 mins.	2 Kw.
31	12.45	Vas Diaz	PCFF 1950 m.	Amsterdam	Stocks and Shares	10 mins.	2 Kw.
251	12.45	Lyons	— 280 m.	France	Concert	1.30 p.m.	300 Watts.
23	12.57	Nauen	POZ 3000 m.	Berlin	Time Signal in G.M.T. (Spark). This Signal is relayed by Zurich and all German stations except Munich and Stuttgart	8 mins.	50 Kw.
157	1.0	Zurich	— 515 m.	Switzerland	Weather Forecast, Shares & News	5 mins.	500 Watts
33	1.0	Haeren	BAV 1100 m.	Brussels	Weather Forecast in French and English.	8 mins.	150 Watts.
202	1.15	Munster	— 410 m.	Westphalia	Concert or Lecture	2.30 p.m.	1.5 Kw.
27	1.30	Lausanne	HB2 850 m.	Switzerland	Weather Report, Time Signal in C.E.T. and News	15 mins.	300 Watts.
34	2.0	Munich	— 485 m.	Bavaria	News and Weather Report	10 mins.	1.5 Kw.
37	2.15	Voxhaus	— 505 m.	Berlin	Stock Exchange News	5 mins.	4.5 Kw.
35	2.30	Komarow	— 1800 m.	Czecho-Slovakia	Stock Exchange and Late News	10 mins.	1 Kw.
39	2.45	Eiffel Tower	FL 2650 m.	Paris	Exchange Opening Prices (Saturday excepted).	8 mins.	5 Kw.
181	3.0	Breslau	— 418 m.	Silesia	News and Exchange Quotations	10 mins.	1.5 Kw.
40	3.0	Munster	— 410 m.	Westphalia	Stocks, Shares and News	10 mins.	1.5 Kw.
47	3.30	Eiffel Tower	FL 2650 m.	Paris	Exch. Quotations (Sat. excepted)	5 mins.	5 Kw.
250	4.0	Munich	— 485 m.	Bavaria	Concert	6 p.m.	1.5 Kw.
159	4.10	Radio-Wien	— 530 m.	Vienna	News, followed by Concert	6 p.m.	1.5 Kw.
42	4.30	Frankfurt	— 470 m.	Germany	Light Orchestra	6 p.m.	1.5 Kw.
46	4.30	Leipzig	— 454 m.	Germany	Concert	6 p.m.	4.5 Kw.



Ref. No.	B. S. T.	Name of Station.	Call Sign and Wave-length	Situation.	Nature of Transmission.	Closing Time or Approx. Duration.	Approx. Power used.
<b>WEEK DAYS (Contd.)</b>							
52	p.m.	Eiffel Tower	FL 2650 m.	Paris	Exch. Closing Prices (except Sat.)	8 mins.	5 Kw.
240	4.30	Vaz Diaz	PCFF 1950 m.	Amsterdam	Time Signal, Stocks and Shares	3 mins.	2 Kw.
226	4.30	Stuttgart	— 443 m.	Wurtemberg	Concert	6 p.m.	1.5 Kw.
44	5.0	Voxhaus	— 505 m.	Berlin	Concert, followed by News	6.30 p.m.	1 Kw.
43	5.0	Konigsberg	— 463 m.	East Prussia	Light Orchestra (Wed. and Sat., Children's Hour)	6 p.m.	1 Kw.
158	5.0	Zurich	— 515 m.	Switzerland	Concert by Hotel Baur-au-Lac .. relayed	6 p.m.	500 Watts.
160	5.0	Breslau	— 418 m.	Silesia	Light Orchestra	6 p.m.	1.5 Kw.
54	5.0	Radio-Belge	SBR 265 m.	Brussels	Concert, followed by News	6 p.m.	2.5 Kw.
263	5.10	Hilversum	NSF 1050 m.	Holland	Concert, followed by News (Mon. excepted)	7.15 p.m.	1.5 Kw.
186	6.0	Frankfurt	— 470 m.	Germany	Lectures	7.30 p.m.	1.5 Kw.
187	6.0	Hamburg	— 395 m.	Germany	Music or Lecture	7 p.m.	1.5 Kw.
241	6.0	Warsaw	PTR 385 m.	Poland	Concert	7 p.m.	—
162	6.15	Eiffel Tower	FL 2650 m.	Paris	Concert, followed by News Bulletin	7.10 p.m.	5 Kw.
161	6.30	Munich	— 485 m.	Bavaria	Lecture	8 p.m.	1.5 Kw.
298	7.0	Barcelona	EAJ 325 m.	Spain	Concert	8 mins.	650 Watts.
299	7.0	Komarov	— 1800 m.	Brunn	Concert	8 p.m.	1 Kw.
264	7.15	Oslo	— 382 m.	Norway	Time Signal and Concert	9 p.m.	1 Kw.
234	7.30	Strassnice	— 550 m.	Prague	Concert	10 p.m.	500 Watts.
228	7.50	Hilversum	NSF 1050 m.	Holland	Concert on Monday, 6.40-8.40 p.m.	9.10 p.m.	5 Kw.
63	8.0	Stuttgart	— 443 m.	Wurtemberg	Lecture, followed by Evening Programme.	11 p.m.	1.5 Kw.
58	8.0	Eiffel Tower	FL 2650 m.	Paris	General Weather Forecast	8 mins.	5 Kw.
188	8.0	Frankfurt	— 470 m.	Germany	Lecture	8.30 p.m.	1.5 Kw.
61	8.0	Konigsberg	— 463 m.	East Prussia	Concert and Late News	10 p.m.	1 Kw.
62	8.0	Hamburg	— 395 m.	Germany	Concert, Late News and Dance Music.	11 p.m.	1.5 Kw.
300	8.0	Radio Catalana	EAJ 460 m.	Barcelona	Concert	10 p.m.	1 Kw.
301	8.0	Bilbao	EAJ9 415 m.	Spain	Concert	10 p.m.	1 Kw.
66	8.0	Lausanne	HB2 850 m.	Switzerland	Concert (Wednesdays excepted)	9.30 p.m.	300 Watts.
73	8.0	Munich	— 485 m.	Bavaria	Concert and News	11 p.m.	1.5 Kw.
60	8.0	Radio-Wien	— 530 m.	Vienna	Evening Programme	10 p.m.	1.5 Kw.
302	8.5	Graz	— 404 m.	Austria	Concert	10 p.m.	1.5 Kw.
74	8.15	Radio-Belge	SBR 265 m.	Brussels	Concert, preceded and followed by News.	10.10 p.m.	2.5 Kw.
64	8.15	Zurich	— 515 m.	Switzerland	Concert, followed by Late News	10 p.m.	500 Watts.
65	8.15	Leipzig	— 454 m.	Germany	Concert and News (3 days a week until 11.30 p.m.)	10 p.m.	1.5 Kw.
76	8.15	Radio-Paris	SFR 1750 m.	Clichy	Detailed News Bulletin	8.45 p.m.	8 Kw.
242	8.25	Royal Dutch Meteorological Inst.	KNML 1100 m.	Utrecht	Night Frost Report	5 mins	2 Kw.
164	8.30	Radiofonica Italiana	IRO 425 m.	Rome	Concert, followed by News and Dance Music	11 p.m.	3 Kw.
254	8.30	Radio Toulouse	— 275 m.	France	Concert Tests	10 p.m.	2 Kw.
97	8.30	Frankfurt	— 470 m.	Germany	Concert and News	11 p.m.	1.5 Kw.
59	8.30	Munster	— 410 m.	Westphalia	Concert, followed by News	10.45 p.m.	1.5 Kw.
72	8.30	Voxhaus	— 505 m.	Berlin	Concert, followed by News and Weather Report	10.30 p.m.	4.5 Kw.
69	8.30	Breslau	— 418 m.	Silesia	Concert	10 p.m.	1.5 Kw.
253	8.30	Agen	— 318 m.	France	Exchange Quotations and News Bulletin (Concert once a week)	9 p.m.	250 Watts.
77	8.45	Radio-Paris	SFR 1750 m.	Clichy	Time signal followed by Concert	10 p.m.	6 Kw.
177	9.0	Radio-Barcelona	EAJ1 325 m.	Barcelona	Concert	11 p.m.	650 Watts.
75	9.0	Ecole Sup. des Postes	FPTT 458 m.	Paris	Concert, sometimes preceded by Lecture	10 p.m.	500 Watts.
164	9.0	Un. Radiofonica Italiana	— 425 m.	Italy	Concert, followed by News and Dance Music	1.30 p.m.	4 Kw.
245	9.0	Lyngby	— 2400 m.	Denmark	Press News	9.15 p.m.	—
252	9.0	Lyons	— 280 m.	France	Concert	10 p.m.	300 Watts.
78	10.0	Radio-Iberica	RI 392 m.	Madrid	Concert and Advertisements	1 a.m.	3 Kw.
79	11.0	Eiffel Tower	FL 2650 m.	Paris	Time Signal in Greenwich Sidereal Time (Spark)	5 mins.	60 Kw.
80	11.10	Eiffel Tower	FL 2650 m.	Paris	Weather Forecast	5 mins.	5 Kw.
81	11.44	Eiffel Tower	FL 2650 m.	Paris	Time Signal in G.M.T. (Spark)	3 mins.	60 Kw.
82	12.57	Nauen	POZ 3000 m.	Berlin	Time Signal in G.M.T. (Spark)	8 mins.	50 Kw.

**SUNDAYS.**

83	a.m.	Frankfurt	— 470 m.	Germany	Morning Prayer	1 hour	1.5 Kw.
85	8.30	Leipzig	— 454 m.	Germany	Morning Prayer	10 a.m.	1.5 Kw.



Bush House,  
London, W.C.2.

Dear Sir,

On September 15<sup>th</sup> my company is producing an entirely new weekly paper called "Wireless" which will sell at 2D - an absurdly low figure for a Radio Press paper. I anticipate a circulation far in excess of any similar paper - this being the biggest enterprise we have ever undertaken.

Mr Harris and I have spent eight months in perfecting our plans, and we are satisfied that our new weekly "WIRELESS" will meet with an extraordinary welcome from the wireless public

Yours truly,

John Scott-Taggart



Ref. No.	B. S. T.	Name of Station.	Call Sign and Wave-length.	Situation.	Nature of Transmission.	Closing Time or Approx. Duration.	Approx. Power used.
<b>SUNDAYS (Contd.)</b>							
	a.m.						
165	9.0	Konigsberg ..	— 463 m.	E. Prussia	Morning Prayer .. .. .	9.45 a.m.	1 Kw.
212	9.0	Voxhaus ..	— 505 m.	Berlin ..	Morning Prayer .. .. .	10 a.m.	4.5 Kw.
265	9.0	Helsingfors ..	— 370 m.	Finland ..	Divine Service .. .. .	9.30 a.m.	1 Kw.
214	9.0	Munster ..	— 410 m.	Westphalia	Morning Prayer .. .. .	10.0 a.m.	1.5 Kw.
213	9.40	Bloemendaal ..	— 350 m.	Holland ..	Divine Service .. .. .	1 hour	1 Kw.
86	10.0	Komarow ..	— 1800 m.	Czecho-Slovakia	Sacred Concert .. .. .	1 hour	1 Kw.
	10.0	Ryvang ..	— 1150 m.	Sweden ..	Divine Service .. .. .	11.0 a.m.	800 Watts.
256	10.0	Copenhagen ..	— 775 m.	Denmark ..	Divine Service .. .. .	11.15 a.m.	1.5 Kw.
87	10.23	Eiffel Tower ..	FL 2650 m.	Paris ..	Time Signal in G.M.T. (Spark) ..	3 mins.	60 Kw.
89	11.0	Eiffel Tower ..	FL 2650 m.	Paris ..	Time Signal in Greenwich Side-real Time (Spark)	5 mins.	60 Kw.
207	11.0	Oslo ..	— 382 m.	Norway ..	Divine Service .. .. .	Noon.	1 Kw.
90	11.0	Strasnice ..	— 550 m.	Prague ..	Classical Music .. .. .	1 hour	1 Kw.
92	11.5	Radio-Wien ..	— 530 m.	Vienna ..	Concert .. .. .	12.50 p.m.	1.5 Kw.
94	11.30	Stuttgart ..	— 443 m.	Wurtemberg	Classical Concert .. .. .	1 hour	1.5 Kw.
192	11.30	Munich ..	— 485 m.	Bavaria ..	Sacred Concert .. .. .	1.0 p.m.	1.5 Kw.
96	11.30	Konigsbrunnen ..	LP 1300 m.	Berlin ..	Concert .. .. .	12.50 p.m.	10 Kw.
95	11.44	Eiffel Tower ..	FL 2650 m.	Paris ..	Time Signal in G.M.T. (Spark)	3 mins.	60 Kw.
97	11.55	Eiffel Tower ..	FL 2650 m.	Paris ..	Fish Market Quotations ..	4 mins.	5 Kw.
	Noon						
98	12.0	Stockholm ..	SASA 440 m.	Sweden ..	Divine Service .. .. .	1.15 p.m.	1 Kw.
273	12.0	Breslau ..	— 418 m.	Silesia ..	Sacred Concert .. .. .	12.55 p.m.	1.5 Kw.
	p.m.						
102	12.45	Radio-Paris ..	SFR 1750 m.	Clichy ..	Concert, followed by News ..	1.45 p.m.	8 Kw.
101	12.57	Nauen ..	POZ 3000 m.	Berlin ..	Time Signal in G.M.T. (Spark)	3 mins.	50 Kw.
268	1.10	Hilversum ..	NSF 1050 m.	Holland ..	Concert .. .. .	4.40 p.m.	2.5 Kw.
215	2.0	Munster ..	— 410 m.	Westphalia	Concert .. .. .	4.0 p.m.	1.5 Kw.
216	3.0	Lynby ..	— 2400 m.	Denmark ..	News .. .. .	10 mins.	500 Watts.
108	4.30	Munich ..	— 485 m.	Bavaria ..	Concert .. .. .	5.0 p.m.	1.5 Kw.
107	4.0	Frankfurt ..	— 470 m.	Germany ..	Children's Corner .. .. .	5.0 p.m.	1.5 Kw.
106	4.0	Radio-Wien ..	— 530 m.	Vienna ..	Afternoon Concert .. .. .	6.0 p.m.	1.5 Kw.
169	4.30	Voxhaus ..	— 505 m.	Berlin ..	Light Orchestra .. .. .	6.0 p.m.	4.5 Kw.
170	4.30	Leipzig ..	— 454 m.	Germany ..	Light Orchestra .. .. .	6.0 p.m.	1.5 Kw.
105	4.30	Stuttgart ..	— 443 m.	Wurtemberg	Light Orchestra .. .. .	6 p.m.	1.5 Kw.
217	4.40	Bloemendaal ..	— 350 m.	Holland ..	Divine Service .. .. .	5.40 p.m.	1 Kw.
167	5.0	Zurich ..	— 515 m.	Switzerland	Hotel Baur-au-lac, Concert re-layed	6.0 p.m.	500 Watts.
171	5.0	Frankfurt ..	— 470 m.	Germany ..	Light Orchestra .. .. .	6.0 p.m.	1.5 Kw.
168	5.0	Konigsberg ..	— 463 m.	East Prussia	Light Orchestra .. .. .	6.0 p.m.	1 Kw.
111	5.0	Radio-Belge ..	SBR 265 m.	Brussels ..	Concert .. .. .	1 hour	2.5 Kw.
257	6.0	Hamburg ..	— 395 m.	Germany ..	Concert .. .. .	7.0 p.m.	1.5 Kw.
219	6.0	Malmö ..	SASC 270 m.	Sweden ..	Concert .. .. .	8.0 p.m.	1 Kw.
112	6.15	Eiffel Tower ..	FL 2650 m.	Paris ..	Concert, followed by News ..	1 hour	5 Kw.
180	7.0	Barcelona ..	EAJ1 325 m.	Spain ..	Concert .. .. .	10.30 p.m.	650 Watts.
269	7.15	Oslo ..	— 475 m.	Norway ..	Lecture and Concert .. .. .	9.0 p.m.	1 Kw.
270	7.40	Hilversum ..	NSF 1050 m.	Holland ..	Concert .. .. .	9.10 p.m.	2.5 Kw.
237	8.0	Strasnice ..	— 550 m.	Czecho-Slovakia	Concert .. .. .	9.0 p.m.	1 Kw.
176	8.0	Copenhagen ..	— 775 m.	Denmark ..	Concert, followed by News ..	9.30 p.m.	1.5 Kw.
114	8.0	Radio-Wien ..	— 530 m.	Vienna ..	Concert .. .. .	10.0 p.m.	1.5 Kw.
118	8.0	Konigsberg ..	— 463 m.	E. Prussia	Concert .. .. .	10.0 p.m.	1 Kw.
173	8.0	Frankfurt ..	— 470 m.	Germany ..	Lecture, followed by evening programme	10.0 p.m.	1.5 Kw.
119	8.0	Hamburg ..	— 395 m.	Germany ..	Concert, followed by News ..	11.0 p.m.	1.5 Kw.
120	8.0	Eiffel Tower ..	FL 2650 m.	Paris ..	General Weather Forecast ..	8 mins.	5 Kw.
125	8.0	Stuttgart ..	— 443 m.	Wurtemberg	Concert, Dance Music from 10.0 p.m.	11 p.m.	1 Kw.
174	8.0	Munich ..	— 485 m.	Bavaria ..	Concert .. .. .	11.30 p.m.	1 Kw.
124	8.0	Breslau ..	— 418 m.	Silesia ..	Light Orchestra, Dance Music at 10.0 p.m.	10.30 p.m.	1.5 Kw.
121	8.0	Lausanne ..	HB2 850 m.	Switzerland	Concert or Talk .. .. .	9.30 p.m.	300 Watts
128	8.15	Radio-Paris ..	SFR 1750 m.	Clichy ..	Detailed News Bulletin ..	9.0 p.m.	8 Kw.
122	8.15	Zurich ..	— 515 m.	Switzerland	Concert .. .. .	10.0 p.m.	500 Watts.
123	8.15	Leipzig ..	— 454 m.	Germany ..	Symphony Concert .. .. .	10.0 p.m.	1.5 Kw.
127	8.30	Radio-Belge ..	SBR 265 m.	Brussels ..	Concert, followed by News ..	10.10 p.m.	2.5 Kw.
116	8.30	Munster ..	— 410 m.	Westphalia	Classical Concert .. .. .	10.0 p.m.	1.5 Kw.
220	8.30	Voxhaus ..	— 505 m.	Berlin ..	Evening Programme .. .. .	11.0 p.m.	1.5 Kw.
129	8.30	Ecole Superieure	FPTT 458 m.	Paris ..	Concert or Lecture (May begin 15 mins. earlier or later)	10.30 p.m.	500 Watts





## Tune in More Stations

(those hard to get ones that you are always missing) by replacing your Old Dials with

**Pelican** At your Dealer **6/-**  
**UNIVERNIER**

Pell, Cahill & Co., Ltd., 64 Newman St., W.1

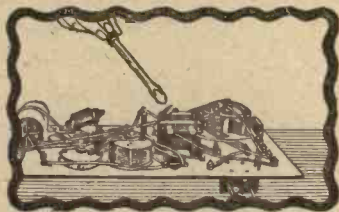

Your soldering iron can't burn or melt

# GLAZITE

**THE NEW COLOURED CONNECTING WIRE**

BY using "Glazite" you have none of the old insulating sleeving to manipulate or burn.

"Glazite" Connecting Wire is already insulated and is flame-proof. "Glazite" consists of tinned copper wire, first covered with cotton and then with a film of heavy insulating material. "Glazite" will not deteriorate.

Made in four colours—red, blue, yellow and black. Obtainable from all radio dealers packed as follows:

10-ft. coils (1/18 s.w.g.) price 1/2d. per coil.  
2-ft. lengths (1/16 s.w.g.), 4 lengths in an envelope, assorted colours, price 1/- per packet.

Write for Glazite leaflet and name of nearest stockist.

**The LONDON ELECTRIC WIRE CO. & SMITHS LTD.**

PLAYHOUSE YARD, GOLDEN LANE, LONDON, E.C.1  
Telegrams: Electric, London. Telephone: Clerkenwell 1383, 1382, 1390, 1391

## The Loud Speaker Season.

Autumn—the season of falling leaves and longer evenings. When tennis after 7 o'clock is impracticable and one must needs look indoors for amusement—that is the time the "Sparta" is appreciated. There's nothing harsh or discordant about its reproduction. It's just a natural voice bringing to your home all the good things of wireless—exactly as they are given before the microphone. Nothing added—nothing lost. *Just re-creation.*

Be prepared for Autumn. Ask your Dealer for a demonstration and let your own ear prove how extraordinarily good its reproduction is.



Type "A," 120 ohms.  
Type "H.A.," 2,000 ohms  
Type "H.H.A.,"  
4,000 ohms.  
£4 15s.  
The "Little" Sparta,  
55/-

Type "B," ohms.  
£51  
Type "H.B.," 2,000 ohms, £6.  
Type "H.H.B.," 4,000 ohms, £8.

Every component used in the "Sparta" is the outcome of equally careful thought—it is, in fact, the co-ordination into one instrument of all the worth-while features in Loud Speaker construction.

All Type "B" Speakers are characterised by the patent 6 position tone selector. This consists of an ingenious arrangement of blocking condensers, which smooths away all trace of harshness, resulting in a remarkably pure distinctness of tone.

# SPARTA

## LOUD SPEAKER

Fuller's United Electric Works, Ltd.  
Woodland Works, Chadwell Heath, Essex.

JUDD,

In replying to advertisers, use Order Form enclosed.



Ref. No.	B. S. T.	Name of Station.	Call Sign and Wavelength.	Situation.	Nature of Transmission.	Closing Time or Approx. Duration.	Approx. Power used.
<b>SUNDAYS (Contd.)</b>							
175	p.m. 8.30	Radiofonica-Italiana	— 425 m.	Rome	Concert, followed by Late News	11.0 p.m.	3 Kw.
130	8.45	Radio Paris	SFR 1780 m.	Clichy	"Radio Ball" Programme of Dance Music	10.30 p.m.	8 Kw.
131	9.15	Petit-Parisien	— 345 m.	Paris	Concert (items announced in English as well as French)	11.0 p.m.	500 Watts.
132	10.0	Radio-Iberica	RI 392 m.	Spain	Concert	1 a.m.	3 Kw.
133	11.0	Eiffel Tower	FL 2650 m.	Paris	Time Signal in Greenwich Sidereal Time (Spark)	3 mins.	60 Kw.
134	11.44	Eiffel Tower	FL 2650 m.	Paris	Time Signal in Greenwich Mean Time (Spark)	3 mins.	60 Kw.
135	12.57	Nauen	POZ 3000 m.	Berlin	Time Signal in G.M.T. (Spark)	8 mins.	50 Kw.

<b>SPECIAL DAYS.</b>							
156	a.m. 11.0	Radio-Wien	— 530 m.	Austria	Tues., Thurs., Sat., Concert	12.50 p.m.	1.5 Kw.
224	p.m. 4.45	Munich	— 485 m.	Bavaria	Wed., Children's Corner	½ hour	1.5 Kw.
	4.45	Radio Paris	SFR 1780 m.	Clichy	Tues., Dance Music	5.45 p.m.	6 Kw.
142	5.40	Ned. Seintoes-Fabriek	NSF 1050 m.	Hilversum	Mon., Children's Hour	6.40 p.m.	3 Kw.
203	6.0	Gotenborg	SMZX 460 m.	Sweden	Tues., Concert	8 p.m.	300 Watts.
137	6.15	Lausanne	HB2 850 m.	Switzerland	Wed., Children's Corner	1 hour	300 Watts.
180	6.30	Belgrade	HFF 1650 m.	Serbia	Tues., Thurs. and Sat., Concert	1 hour	500 Watts.
271	7.0	Helsingfors	— 370 m.	Finland	Tues., Thurs. and Sat., Concert	9.0 p.m.	1 Kw.
147	7.0	Stockholm	— 440 m.	Sweden	Wed., Thurs., Fri., Sat., Concert	8 p.m.	—
221	8.0	Copenhagen	— 775 m.	Denmark	Thurs. and Sat., Concert	9.30 p.m.	1.5 Kw.
258	8.30	Ryvang	— 1150 m.	Denmark	Tues., Wed. and Sat., Concert	9.30 p.m.	800 Watts.
151	8.40	Amsterdam	PXG 1050 m.	Holland	Mondays, Concert	10.40 p.m.	600 Watts.
225	8.45	Le Matin	SFR 1750 m.	Paris	Sat., Special Gala Concert	11 p.m.	6 Kw.
223	9.0	Malmo	SASC 270 m.	Sweden	Thurs. and Sat., Dance Music	11 p.m.	500 Watts.
154	9.15	Petit-Parisien	— 345 m.	Paris	Tues. and Thurs., Concert (items announced in English as well as French)	11.0 p.m.	500 Watts.
210	10.0	Radio-Wien	— 530 m.	Vienna	Wed. and Sat., Dance Music	11.30 p.m.	1.5 Kw.
155	10.0	Radio-Paris	SFR 1750 m.	Clichy	Two evenings per week, Dance Music	10.45 p.m.	8 Kw.
232	10.0	Voxhaus	— 505 m.	Berlin	Thurs. and Sat., Dance Music	Midnight	4.5 Kw.
272	11.0	Munich	— 485 m.	Bavaria	Wed. and Sat., Dance Music	Midnight to 1.0 a.m.	1.5 Kw.

The following are Relay Stations:—

Kassel, 288 m., 1 kw.; relays Frankfurt. Nuremberg, 340 m., 1 kw.; relays Munich.  
 Dresden, 292 m.; mostly relays Leipzig. Graz, 404 m.; relays Radio-Wien.  
 Hjarring Radiofonistation, 1250 m.; relays Ryvang. Odense Radiotelefonistation, 950 m.; relays Ryvang.  
 Lyons La Doua, 480 m., Marseill s, 350 m., and Toulouse, 310 m.; relays Ecole Superieure, Paris.  
 Bremen, 279 m., 1 kw.; and Hanover 296 m., 1 kw.; relay Hamburg.

SIR,—Having just completed the Distinctive Two-Valve Receiver described by Mr. Rattee in the August, 1924, number of MODERN WIRELESS, I thought you might be interested in the results obtained. I have built the set with parts as specified, the only difference is I am using a Sterling Square Law Condenser with Vernier instead of the Bowyer Lowe. I have a twin aerial, 40ft. long and 16 ft. high, with a 4 ft. down lead. I am delighted with the results. Within five minutes of making the last soldered joint I was listening to Bournemouth, good and strong. I have picked up all the B.B.C. stations, including all the relays, also Madrid and two French

## A Distinctive Two-Valve Receiver.

stations. I have also picked up KDKA direct. These stations all come through perfectly, and the volume is tremendous from Bournemouth, Manchester, London and Madrid. KDKA, of course, was not so strong, but I could hear comfortably what the an-

nouncer said. I think it is a wonderful little set. I am very pleased with it, and must congratulate Mr. Rattee. I can get all stations, using tuned anode coupling, up to Newcastle with a No. 35 coil, and the remainder with a No. 50. I have a two-valve Marconiphone on which I have picked up my experience, and I am a regular reader of all your publications.—Yours truly,

FRED W. JOHNSEN.

Tullamore, Ireland.

P.S.—I forgot to say that the set is very selective, easy to control, and there is no difficulty in picking up stations.



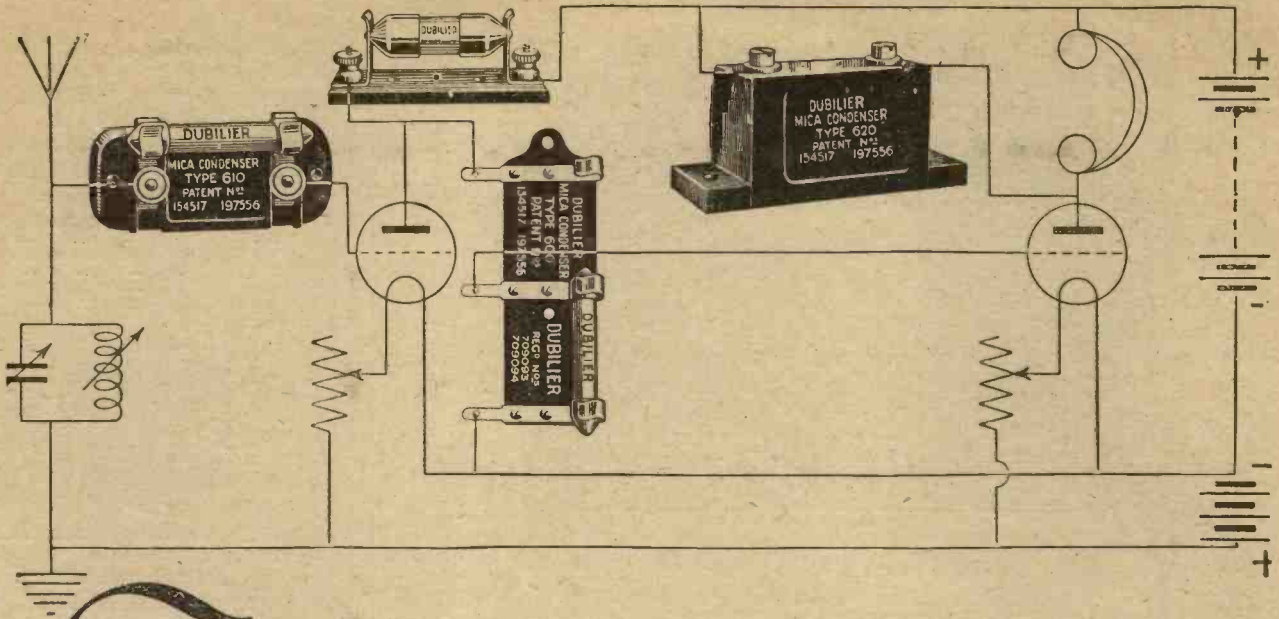

# Further Small Matters-

**T**HE components illustrated above are small but important. They are the highly specialised products of a notable firm—one which, among other things, was responsible for the introduction of Mica Condensers. Further, these components are characterised by the now well-known Dubilier standards of neatness and finish in construction and reliability in operation.

There is the Type 600 Dubilier Mica Condenser, for example:— a fixed condenser whose capacity is guaranteed by us to be accurate within close limits that are not often met with elsewhere.

A new Dubilier Grid-Leak Attachment is sold for use with it, and is illustrated above. It enables a Grid Leak to be inserted direct between the Grid and L.T. leads simply by clipping in, making use of one of the condenser clips and the clip on the attachment.

The Dubilier Anode Resistance, again, designed for extreme stability in operation, is tested during manufacture to 200 volts, and is absolutely reliable.

The new Dubilier Type 610 Mica Condenser is also shown. It was dealt with in a previous advertisement of this series—“Little Things that Matter.” It is suitable for use everywhere in receiving circuits, and is provided with screw terminals and detachable Grid Leak Clips.

For specialised products such as these, it is always easier and better to specify—

Mica Condenser, Type 600 (Also Type 600A for vertical panel mounting).	0.0001—0.0003 mfd. . . 2/6
	0.001—0.006 mfd. . . 3/-
Mica Condenser, Type 610 (with Grid Leak clips) (Also Type 620 for panel mounting).	0.0001—0.0003 mfd. . . 3/-
	0.001—0.009 mfd. . . 3/6
	0.01 mfd. . . . . 4/-
	0.011—0.015 mfd. . . 4/6
Grid Leak Attachment, 6d. (for use with Type 600).	
Anode Resistance complete with holder 20,000—100,000 ohms	5/6
Grid Leak 0.5, 1, 2, 3, 4 & 5 megohms.	2/6

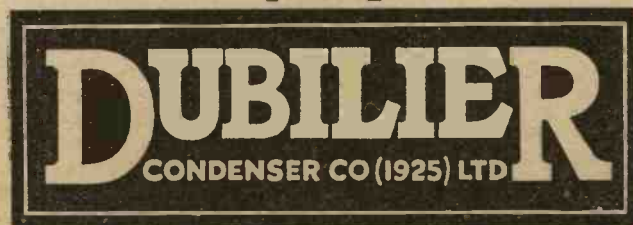
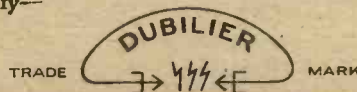

ADVERTISEMENT OF THE DUBILIER CONDENSER CO. (1925), LTD., DUCON WORKS, VICTORIA ROAD, NORTH ACTON, LONDON, W.3. TELEPHONE: CHISWICK 2241-2-3.

E.P.S. 108

In replying to advertisers, use Order Form enclosed.



Advertisement of Portable Utilities Co. Ltd., Fisher St., W.C.1

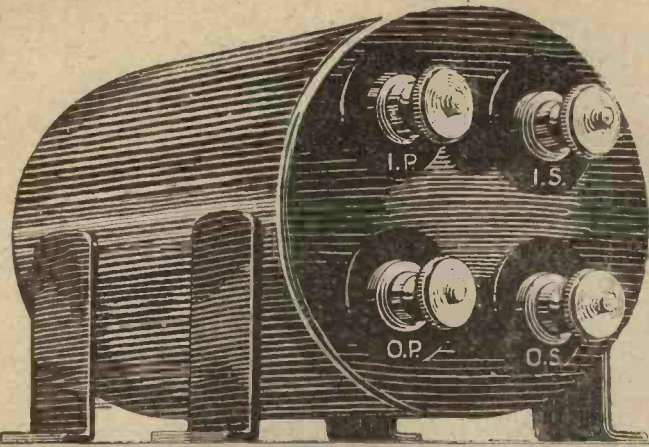

## Eureka introduces three new models:

FOR the past two years Eureka has been accepted as the finest Transformer that money can buy. It has always been selected by those to whom quality of reproduction is the first essential. Owing to its unique principles of construction and the immense amount of fine copper wire involved, it is of necessity high-priced. As a result, although coveted by every discriminating amateur, not everyone can afford to buy it.

Six months' work in our extensive laboratories has now enabled us to reproduce for the first time in the new Eureka Baby Grand a worthy competitor of the famous Concert Grand. The same quality of workmanship—the same freedom from breakdown—the same high-grade materials—the same purity of tone—still the same Eureka but in a smaller size.

No longer is it necessary for you to accept an inferior substitute because the Concert Grand is beyond your means—choose the Eureka Baby Grand and you are guaranteed the same Eureka standard of quality.

### Everyone can now afford the Eureka

**Eureka Baby Grand. No. 1**  
A new and inexpensive first stage Transformer embodying all the well-proved Eureka principles. Unconditionally guaranteed. Price 15/.

**Eureka Baby Grand. No. 2**  
Specially designed to follow the Baby Grand No. 1 when two stages of l.f. amplification are wanted. Unconditionally guaranteed. Price 15/.

**Eureka Reflex Transformer**  
The first Transformer ever to be placed on the market as being specially designed for reflex work. This fine quality instrument will give considerably more volume in a

reflex circuit than any standard transformer. Unconditionally guaranteed. Price 15/.

**Eureka Concert Grand**  
The well-known Eureka Transformer selected by experienced radio engineers for its wonderful amplification with a complete absence of distortion. Unconditionally guaranteed. Price 25/.

**Eureka No. 2**  
Specially designed for use as a second stage transformer with the Concert Grand. Unconditionally guaranteed. Price 21/.

Don't experiment—specify Eureka

# EUREKA

## AGAR for Distinctive Radio Cabinets

Hand made in selected well-seasoned wood in Polished Mahogany, Oak, or Waxed Teak by highly skilled craftsmen to your own particular design or requirements.

For better Loud Speaker Reproduction. Filter Tone Control Unit by C. P. Allinson.

Hand made, Hand Polished Mahogany or Oak Cabinet .. 17/6  
Ebonite Panel, Radion or Siemens .. 5/-  
Engraving .. 3/6  
Drilling .. 1/3  
Complete set of Components as original article—£2 15 6.



Self Contained Three Valve Receiver By Mr. J. Underdown.

Cabinet as original, Mahogany or Oak .. 27/6  
Ebonite Panel .. 10/-

**W. H. AGAR,**  
Manufacturer of Telephone & Radio Apparatus  
19, Whitecross Pl., Wilson St., E.C.2  
Tel. : London Wall 3305. Est. 1912.

**Keep your boys at HOME with a Riley Biliard Table**

By sending 14/- you may have a 6-ft. "Home" Biliard Table (Cash Price £11 15/-) delivered carr. paid to your door, and pay the balance in easy payments while you play. 7 days' free trial given. See list for sizes and designs.

**E. J. Riley Ltd.** Renford Works ACCRINGTON. Send now for Price List.

## MOUNTS IN MORE WAYS than any other



**THE L. & P. UNIVERSAL VERNIER COIL HOLDER** gives the finest control of coupling ever achieved.

Designed for "one-hole" panel mounting. Easily fitted back or front of panel. The action of the moving coil-holder is on the worm and pinion principle, together with a special patented spring which balances the weight of the moving coil. This combination gives a smoothness and delicacy of control not to be experienced with any other device whatsoever. Every part of the workmanship is superb. All metal heavily plated. Only PURE ebonite used—no Now mouldings. This device Reduced will make all the difference between 'getting' to a distant station and 8/6 'just missing it.'

Do not buy a coil holder of any kind until you have had our list. Sent free on request. Mention name of dealer when writing.

**LONDON & PROVINCIAL RADIO CO., LTD.,** 28, Colina Lane, Colne, Lancs.



**WIRELESS EXHIBITION**  
Albert Hall,  
SEPT. 12 to 23.

Gilbert Ad. 3504



# No. 1 of Important Radio Press Weekly. Out September 15th.

Some preliminary details regarding "WIRELESS," the one-word weekly.

ALL readers of MODERN WIRELESS will, no doubt, be interested to hear that the Radio Press Limited are bringing out on Tuesday, September 15th, an entirely new periodical, which will be entitled "Wireless," the price of which paper will be 2d. (two-pence).

The effect of the production of a 2d. weekly paper by the Radio Press will be to create the greatest interest throughout the world of wireless. Hitherto, the Radio Press have not catered for the wide public interested in wireless by means of a weekly paper. Although they possess *Wireless Weekly*, a 6d. periodical having a high-class circulation and appealing to the more technical section of the public, they have never attempted, as yet, to compete with the cheaper weekly wireless papers, or to cater for the large public which buys no technical wireless paper at all.

Practically all MODERN WIRELESS readers buy, in addition, a weekly paper of a popular character. Many of these have said to us, "Why cannot Radio Press, with all their resources, experience and staff, produce a weekly paper on broad popular lines at a cheap price?"

They are now going to, and on Tuesday, September 15th, you will find on every bookstall and in every newsagent's shop a copy of "Wireless"—meant for you to buy.

For 2d. weekly you will receive remarkable value — value which you could never get unless a great wireless publishing organisation were behind the paper. The new Radio Press laboratories are now in operation; two of the buildings are up and several new brilliant engineers have been engaged, as announced elsewhere in this issue.

The organisation of the Radio Press has been strengthened enormously by the great Elstree enterprise and by the acquisition of new engineers who will write for the Radio Press journals.

The contributors to "Wireless" will include the most able writers in the country, including, apart from the laboratory staff, all the well-known Radio Press authors, and also outside contributors of outstanding ability.

Mr. Percy W. Harris paid a special visit to the United States in order to obtain the very latest information regarding American radio designs. We have heard so

and made very careful comparisons and investigations.

He frankly admits that American sets are, generally speaking, far in advance of British designs, and he is going to tell his story, week by week, commencing with No. 1 of "Wireless."

These articles, if they appeared in MODERN WIRELESS, would take months to complete, but by publishing them weekly, the whole extremely valuable information he has gained will be completely available to the wireless public in time to derive the fullest benefit during the winter.

Mr. John Scott-Taggart, F.Inst.P., A.M.I.E.E., will

be contributing, at intervals, to "Wireless," and in No. 1 will appear an article by him of intense interest to all who have built, or read, of the ST.100 receiver. Since this was first designed, in the summer of 1923, great strides have been made as regards general design and circuit improvement. The new ST.100 has been built in the Radio Press laboratories, under the direction of Mr. Scott-Taggart, and full

details will be given in the first issue of "Wireless."

A striking article of universal interest will appear under the name of Major James Robinson, D.Sc., Ph.D., F.Inst.P., Council P.S.L. There will be innumerable other features of extreme interest to our readers, but it will be obvious to our friends that it is not desirable to disclose in advance features which might be copied.

Suffice it to say that the best that money can buy, or brains can produce, will find its place in No. 1 of "Wireless" and in subsequent issues.

The price, 2d., is so small for the value which will be given that only the fullest support by readers and

## AN ANNOUNCEMENT REGARDING

*The New Radio Press Paper entitled*

# "WIRELESS"

THE ONE-WORD WEEKLY.

Edited by PERCY W. HARRIS, M.I.R.E.

Editor-in-Chief: JOHN SCOTT-TAGGART, M.C., F.Inst.P., A.M.I.E.E.

Research Editor: MAJOR JAMES ROBINSON, D.Sc., Ph.D., F.Inst.P.

## No. 1 OUT SEPT. 15TH.

much about the superiority of American radio apparatus, its greater range and its greater selectivity, that we felt it essential to investigate the position at first hand, and Mr. Harris has returned with data and information of extraordinary value and importance. Many articles have appeared, dealing with American methods, written by semi-technical and non-technical authors. Mr. Harris, however, has enjoyed, for several years, a very high reputation in this country as a designer of wireless sets, and he has returned with information which will undoubtedly change, in large measure, the whole trend of apparatus design. He knew exactly what to look for



trade alike would justify it. If it were produced by any other organisation than the Radio Press, the surprise exhibited would not be so great, but the great welcome which the preliminary announcements of this paper have received, indicate that there will be a huge demand on Tuesday, September 15th.

Mr. Percy W. Harris will be the Editor of "Wireless," and Mr. John Scott-Taggart will be Editor-in-Chief. It will be whole heartedly a Radio Press production, and the entire organisation of the company is going to make it the greatest and most successful enterprise they have yet undertaken.

"Wireless" will be in a class by itself; although eminently readable and interesting, and of lighter character than some of the other Radio Press periodicals, the same soundness as regards technical facts and policy will be there. The stamp of the Radio Press will appear on every page, and this is what will make the new weekly different from any existing weekly wireless paper on the market.

September 15th will be a red-letter day, not merely for the Radio Press, but for those masses of expectant readers who have had to buy some other weekly simply

because the Radio Press have had nothing suitable to offer them.

We are out for an entirely new public, but we are confident that

the readers of our monthly periodicals will, to their own advantage, become supporters of "Wireless"—the new Radio Press weekly.

THE ONGAR STATION

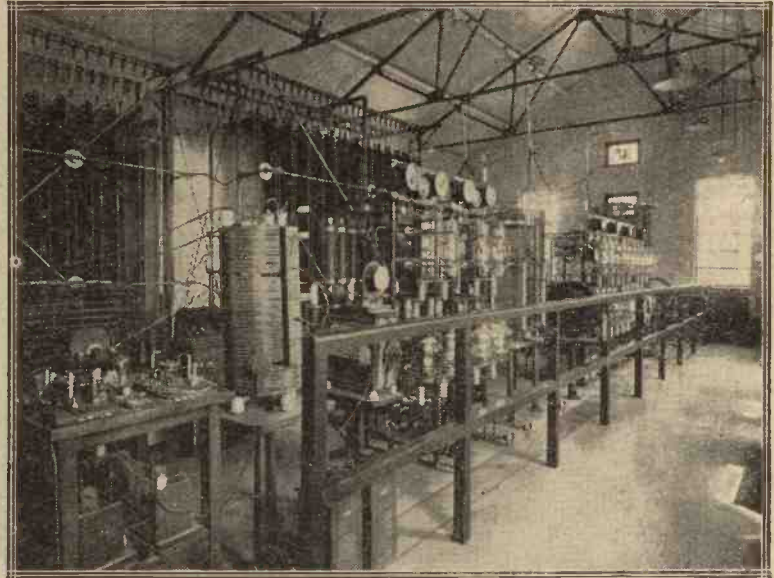

The Marconi 50 kw. continuous wave transmitting station at Ongar, Essex, which maintains a high-speed automatic service with Canada.

**MORRIS** *The Home for Your Wireless Set!*  
**SOLID OAK STANDARD CABINET**  
 with Locks.

To lock up any set and batteries with panel up to 36 x 18.

Sent on approval. Trade supplied.

Price, carriage paid and packing free:

22 in. wide inside	£4 : 15 : 0
24 in. " "	£5 : 0 : 0
36 in. " "	£8 : 0 : 0

**MAKER IMPORT CO., (Dept. 2),**  
 50a, Lord Street, LIVERPOOL.

The Woodhall Vernier Coil-Holder has one-hole fixing, 360° Dial reading and positive terminal

Price 10/6

connections. It operates on an entirely new principle, giving fine adjustments at the "close-coupled" portion of the scale, with positive connections through springs from sockets to terminals. Nickel-plated throughout.

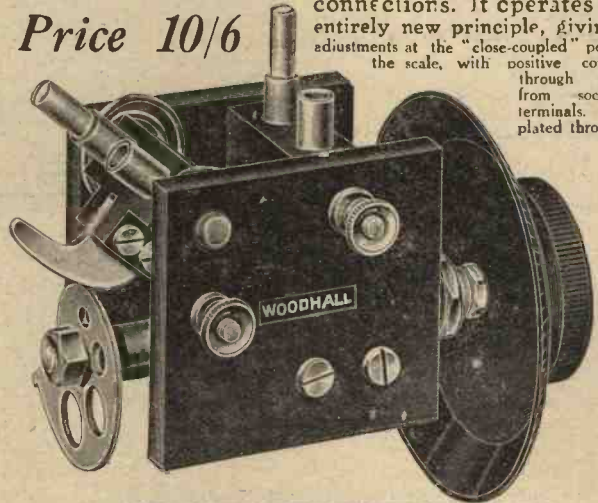

**WOODHALL**

GUARANTEED COMPONENTS  
 Obtainable from all Dealers.

Woodhall Wireless Manfg. Co., Ltd.  
 21, Garrick Street, London, W.C.2  
 (One minute from Leicester Square Tube Station.)

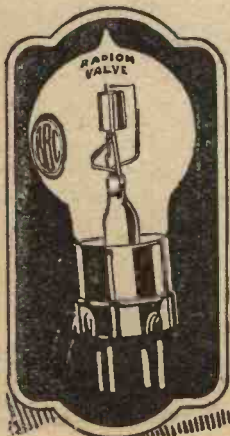

EACH A KING IN ITS CLASS  
 —and Guaranteed British Made.

- Radion G.P. A 4-volt bright valve that only consumes 48 amp. 7/-
- Radion D.E. '06 A wonderfully efficient filament valve 3-volt "very dull" 10/6
- Radion D.E. '34 A 2-volt dull emitter of fine performance 10/6
- Radion Pyramid (1) Valve, 22/6

THE POWER VALVE DE LUXE. Can be used with largest loud-speaker without valve distortion. Filament robust; works at a low temperature, ensuring long life. SPECIAL CONSTRUCTION GIVES HIGHEST EFFICIENCY AND MECHANICAL STRENGTH. Fil. Volts, 6.5; Fil. Amps., .34; Anode Volts, 50-100; Neg. Grid Bias, 3-9.

From untied Dealers or direct, Post Free.  
**RADIONS LTD., BOLLINGTON, nr. Macclesfield, Cheshire**  
 Interesting literature concerning Radion Valves and our unique valve repair service gladly sent free on request.





SIR,—As an enthusiastic amateur during the past three years I have had many sets at one time and another, but the two which held my interest most were (1) the Family

Four-valve Receiver (Radio Press Envelope No. 2, by Percy W. Harris, M.I.R.E.) and (2) Mr. Harris' modification of the Grebe C.R.13 Circuit. (Described in MODERN WIRELESS, February, 1924.) In consequence, last September I built a set which I considered embodied all the best features of these two sets.

One stage of H.F. only is used and no magnetic reaction is employed; using ordinary general-purpose valves in the H.F. position the tuning is moderately sharp; but I found that by substituting a B.6 valve for a B.5 valve in the L.F. the strength of signals was much enhanced.

No potentiometer is used or needed on this set, whilst the set can only be made to oscillate by over-running the high-frequency valve filament. I consider the tonal quality of the set to be equal to the Four-valve Family Receiver, which, as most people

## A Reader's Results with Two Radio Press Circuits

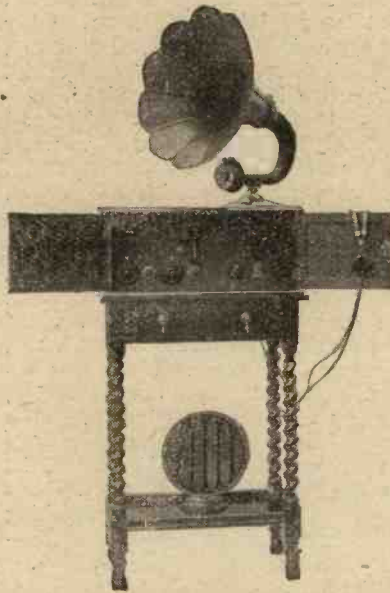

The modified Family 4-valve receiver built by T.F.S.

know, employs magnetic reaction and potentiometer control (this with identical components in each case).

Results obtained are as follows: My aerial is about 26 ft. high at

one end and 16 ft. high at the lead-in end; this is not high, but I am admittedly in a good, un-screened position. I get what most people claim to get with a good 4-valve set employing one stage of H.F., i.e., all main B.B.C. stations and quite a number of Continental ones at good L.S. strength during winter. I cannot always separate Birmingham and Aberdeen, but with a direct coupled aerial tuning circuit I would hardly expect to do so, especially when one considers how Rugby is placed in relationship to these two stations. I have not received America on this set, which I designed to bring in good-quality speech and music, and not as a stunt set. I have a little single-valve KDKA set on which I can hear U.S.A. any time I care to wait till 11.15 p.m.

I am sending you a photograph which I recently took of my set.—  
Yours faithfully, T.F.S.  
Rugby.



### Now introduce a better Grid Leak

Every genuine Therla Grid leak bears the personal guarantee of Faraday House—5 per cent plus or minus.

THE Therla Grid Leak is a definite improvement on other products of its kind. There are good reasons to support this claim. First: Therla Grid Leaks are made by a special, protected process. Second: They are guaranteed to be accurate. Each is individually tested by Faraday House, and the material is the very

best obtainable. Third: A moisture-proof mounting ensures that resistance is permanently maintained. The resistance element contains no india ink or pencil markings, thereby insuring a constant and noiseless leak. Try out the Therla Grid Leak in your set—the improved results will surprise you.

Size	250,000 ohms	} Price 1/9 each.
	500,000 "	
	1,000,000 "	
	1 megohms	
	2 "	
	3 "	

The Therla Fixed Condenser also bears the personal guarantee of Faraday House.

Price	'0001 to '0015
	mfd. 1/3 each.
	'002 mfd. to '006 mfd.
	2/- each

Grid Condenser and leak 3/-

Grid Condenser with clips 1/3.



Sole Distributors:

Telephone: Regent 1140

SEL-EZI WIRELESS SUPPLY CO., LTD., 6, GREEK STREET, LONDON, W.1, and 20, OLD HAYMARKET, LIVERPOOL.

Barclays Ad.

FOR THAT REFLEX

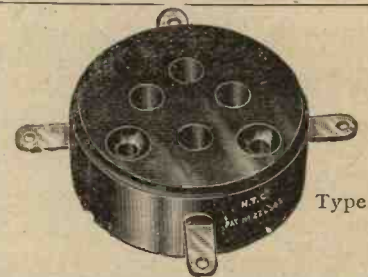

Type B

### H.T.C. Parts will give you better results.

For such Circuits as the S.T.100, in fact for all reflex circuits using crystal rectification, the H.T.C. Fixed Detector is ideal. We find the "hot-spot" and test it on actual broadcast. You simply mount it under the panel if you wish—and it will do the work as no other can do. The H.T.C. Fixed Detector employs a proved mineral crystal combination. Remember, it is a permanent detector.

H.T.C. Fixed Detector	3/6
Detector with Clips	3/9
Complete with Ebonite Base, Clips and Terminals	4/6

It is wise to select radio components that have been proved by popular use to be of the highest radio efficiency. Such components are the H.T.C. products. Experienced experimenters and constructors have, by comparison with components of other makes, proved H.T.C. products to be all that we claim, and have thereby been eminently satisfied.

H.T.C. L.F. Transformer of proved merit... 15/- Give your set range by fitting H.T.C. Low Capacity Valve Holders. For mounting the four-pin valve and the popular plug-in H.F. Transformer you can only expect the best results if you use the H.T.C. Low Capacity Valve Holders. Covered by our patent No. 222345.

Type A (above panel)	1/9
Type B (Board mounting)	1/9
Type C (below panel)	1/6
Type E (Bracket)	2/0
Type F (Board with base and top)	2/3
Type G (Board with base and terminals)	2/6



Insist upon H.T.C. Products at your dealers

H.T.C. Electrical Co., Ltd.

Telephone: Battersea 374.

2-2a, Boundaries Rd., Batham, London, S.W.12

Barclays Ad.

In replying to advertisers, use Order Form enclosed.



## Some Results Obtained with Radio Press Receivers.

### A Single-Valve Reflex Receiver

SIR,—I have built the single-valve reflex receiver as described in Volume III., No. 3, by Mr. Simpson. I find it gives excellent results, although the atmospheric conditions are difficult in South Africa, and also there is a tendency towards fading, which is not due to the set, but I think to the type of atmosphere. I find this set very sensitive and it gives good results on our local 500-watt transmitting station.—Yours truly,  
P. KING.

Johannesburg,  
South Africa.

### An Efficient Single-Valve Receiver

SIR,—Some time ago I wired up the one-valve set described by Mr. Simpson in your June, 1924, issue. It is only a hook-up on an experimental panel. Not having a .0005  $\mu$ F condenser handy, I used a .0003. It certainly is a marvel. I can get all the B.B.C. main stations and many of the

relay stations. Radio Belgique comes in splendidly—in fact better than many of the B.B.C. stations. I have also comfortably heard Petit-Parisien, Frankfurt, Konigsberg, Berlin and Madrid. To cap it all, a few nights ago I and a friend (two pairs of 'phones) heard KDKA. Perhaps you will be surprised to hear that my aerial is single wire (7/22's), only 40 ft. long and 17 ft. high. I have an excellent earth.

This is not a freak reception, because I have done it twice since. I was using an A.R.D.E. valve (Ediswan), about 1.5 volt fil. and only 18 on plate, Watmel variable grid-leak, Ormond condenser, and home-made basket coils (double basket per Mr. Kendal's very useful book "Tuning Coils and How to Wind Them").

I congratulate you on publishing such a remarkably good circuit.—Yours truly,  
K. C. P.

Oldham.

### A Three-Valve Dual

SIR,—Having built the 3-valve dual receiver designed by John Scott-Taggart, and described in MODERN WIRELESS, April, 1924, I have given it constant use, and am writing to let you know of its performance here. I am using two Marconi R.5v valves and one Cossor P.1, Bowyer-Lowe H.F. transformers, and home-wound coils. I can get all the English stations on L.S., except Aberdeen, without the use of telephones. Aberdeen is very good on 'phones. Postes et Telegraphs, Brussels, Radio-Paris, Le Petit Parisien, Eiffel Tower, etc., are very good on L.S.

2LO, 5XX, and Radio-Paris are too loud to be comfortable in a fair-sized room. The set itself is made exactly to the instructions in MODERN WIRELESS, with the exception that I have a fixed resistance instead of a variable one.

Wishing MODERN WIRELESS, *The Wireless Constructor*, and *Wireless Weekly* (of which I am a regular reader) every success.—Yours truly,  
P. A. BLOOM.

Leitchworth.



## COLVERN SELECTOR LOW LOSS

Imagine an analytical chemist without his scientific balances or an engineer without his micrometer!

Similarly, you will never tune a receiver with a direct drive condenser once having experienced the accurate tuning of the Colvern Selector Mechanically Controlled Precision Condenser.

- The Colvern Selector Low Loss—  
Reading to 1/3,600th ca acity  
Capacity .0005 mfd. .. £1 1 0  
" .0003 mfd. .. £1 0 0
- Type F, without gear attachment—  
Capacity .0005 mfd. .. 15 0  
" .0003 mfd. .. 14 0
- One hole fixing. Other capacities if required.  
Descriptive Folder upon request.  
Colvern Independent Vernier—  
Price 2/3

INCORPORATE the Colvern Selector into your receiver—then you can separate stations 3 metres apart—a wonderful experience after the unsatisfactory juggling with the direct drive condenser.

One hole fixing and entire freedom from hand capacity.

ASK YOUR DEALER ALSO FOR THE COLVERN LOW LOSS COIL FORMER Price 6/-

COLLINSON PRECISION SCREW CO., LTD., Provost Works, Macdonald Rd., Walthamstow, London, E. 17. Telephone: Walthamstow 532

Barclays Ad.

THE PANEL

DE LUXE



THE advantage that a Radion Panel confers on a Receiving Set is much more than merely adding a gold case to a watch. Rather, is it comparable to the addition of that delicate compensating balance wheel mechanism which ensures split-second accuracy. If you aim at 100 per cent. efficiency for your Set you'll naturally start with a Radion Panel. With dials to match.

Radion is available in 27 different sizes in black and mahogany. Radion can also be supplied in any special size. Black 1d. per square inch, mahogany 1½d. per square inch.

# RADION

American Hard Rubber Company (Britain) Ltd.

Head Office: 13a Fore Street, London, E.C. 2. Depots: 120 Wellington Street, Glasgow. 116 Snow Hill, Birmingham.

Irish Agents: 8 Corporation Street, Belfast.

Gilbert Ad. 3311



□□□□□□□□□□□□□□□□□□□□□□  
 □ **The GENERAL PURPOSE THREE.** □  
 □□□□□□□□□□□□□□□□□□□□□□

SIR,—Just a line to let you know of the excellent results obtained with the "General Purpose" Three, described by A. Johnson-Randall in MODERN WIRELESS, dated April, 1925.

With the disadvantage of a short aerial (inside), twin, 18 ft. high, 49 ft. long, stranded wire, and a very long earth wire from front garden up to the attic, I have had excellent results from most of the B.B.C. stations, and also from Paris, Germany, Madrid and Rome. I have made several valve sets, but I must say that this one beats them all, and for strength and sweet tone it cannot be beaten. I am only one mile from the Newcastle station, and one night I was able to tune it out all together when the Savoy Bands were on, and listen-in to Radio-Toulouse.

I enclose a log of stations received in July.

Needless to say two or three of my friends are now busy making this set.

Wishing the Radio Press every success.—Yours truly,

W. D. GREEN.

Newcastle-on-Tyne.

STATION.	RECEPTION.	DATE.	TIME.
Aberdeen .. ..	Very good .. ..	July 1	7 p.m.
London .. ..	Poor .. ..	July 2	1 20 p.m.
Foreign, unidentified	Very good .. ..	July 4	8.35 p.m.
Foreign, unidentified	Very good .. ..	July 5	12.20 p.m.
Petit Parisien ..	Very good .. ..	July 5	10.30 p.m., concert.
Radio-Iberica ..	Excellent .. ..	July 5	11.5 p.m. until 12 o'clock.
Radio-Iberica ..	Dance music. "Pasadena" sung by a gentleman.		
Aberdeen .. ..	Excellent .. ..	July 6	10.45 p.m.
London .. ..	Loud enough for loud speaker.	July 6	11.10 till 11.30 p.m.
Radio-Toulouse ..	Fair .. ..	July 7	10.25 p.m.
Aberdeen .. ..	Excellent (children's hour) .. ..	July 8	6 p.m.
Radio-Toulouse ..	Excellent (children's hour) .. ..	July 9	10.45 p.m.
Foreign, unidentified	Poor .. ..	July 12	12 noon.
Foreign, unidentified	Excellent (band) ..	July 12	11.45 p.m.
Hamburg .. ..	Very good .. ..	July 13	12.15 a.m.
Glasgow .. ..	Very good .. ..	July 13	11.20 p.m.
Radio-Toulouse ..	Excellent (dancemusic)	July 13	11.35 p.m.
Bournemouth ..	Very good, testing ..	July 23	11.40 p.m.
Berlin .. ..	Fair. Dance music till midnight .. ..	July 23	11.45 p.m.
Cardiff .. ..	Fair .. ..	July 24	11.0 p.m.
Foreign, unidentified	Fair dance music ..	July 24-25	11.45 p.m. till 12.20 a.m.
Munich .. ..	Very good. Chess talk	July 27	11.0 p.m. till 11.30 p.m.
Amateur transmission, 2 XX	Fair .. ..	Aug. 2	12.30 a.m.
Radio-Catalana and Rome .. ..	Fair .. ..	Aug. 2	11 o'clock and 11.45 p.m.



**SAFETY FIRST!**

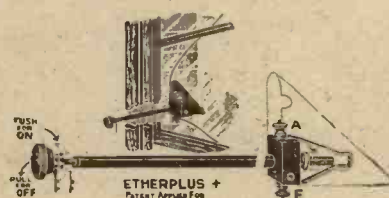

**£100 FREE INSURANCE** against Lightning Damage

The "ETHERPLUS" Patent Lightning-Shunt combines Aerial-earth as well as Lead-in Tube and Switch, and is unique in that it is *always* a Lightning Conductor *whether the set be switched on or off*; in fact a building fitted with it is safer than one without, apart from any question of wireless

From all dealers, or direct (post free) from  
**M.AND.AW.,**  
 9-15, Whitecross Street, London, E.C.1.  
 Full illustrated Catalogue of "Etherplus" Components FREE on application.

Price:  
**3/9**



**Folks, meet a really good condenser!**

That's me! The Efficient Watmel, radio men call me. Efficient—it's my middle name, and you'll say it is when you hear the improvement I make in the results from your radio. Read my test report. Something to be proud of, isn't it? I possess all the good points you look for in a Fixed Condenser and a few more besides. If you're interested in better condenser efficiency—visit your dealer and ask for me. Closer acquaintance will prove to you my sterling qualities.

- Watmel Test Report.
1. Mica Insulation up to 2,000 volts.
  2. Complete Condenser up to 1,000 volts.
  3. Capacity checked.
  4. Insulation up to 500 volts after Final Assembly.
  5. Final Capacity Test.
- ASSESSED OUT 100 per cent. EFFICIENT.
- Prices.  
 Capacities for Standard Grid Condensers.  
 .0005 to .0005 - 2/6 each.  
 Standard Fixed Condensers.  
 .002, .001 - 2/6 each.  
 .0025, .009 - 3/6 each.  
 Combined Grid Leak and Condenser is - 3/- each.

**The Watmel Wireless Co., Ltd.**  
 332a, GOSWELL ROAD, LONDON, E.C. 1.



Representative for Lancashire and Cheshire—  
 E. J. B. LEVÉE, 23, Hartley Street, Levenshulme, MANCHESTER.  
 Barclays Ad.



N.E.R.

L.

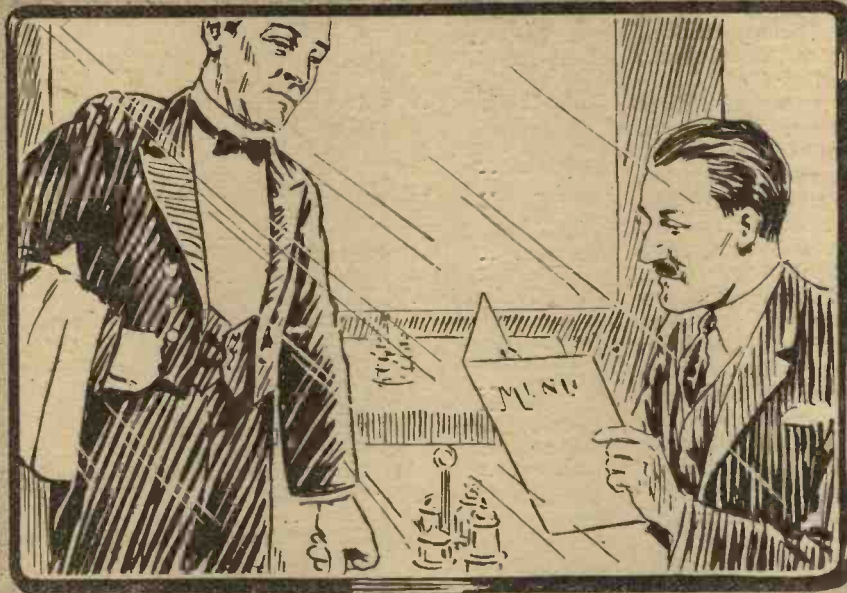

# 1<sup>ST</sup> CLASS

**G**AMBRELL COILS will ensure you perfect first-class accommodation on the Radio Line. They get you to your destination, whether it be your local station or America, in record time, and give results that no others can parallel.

First-class travel always costs a little more. With Gambrell coils that "little more" allows greater care to be taken in their manufacture which is imperative if perfect reception is sought.

GAMBRELL COILS.		Nearest Size in Ordinary Coils.	AERIAL CIRCUIT. Condenser .0005 Mfd. max.			
Size.	Price.		Series.		Parallel.	
			Metres.		Metres.	
a/2	5/9	18	54	131	150	195
a	5/9	25	76	155	180	260
A	5/9	30	95	198	230	360
B	6/-	40	142	272	315	515
B.	6/-	50	194	368	410	710
C	6/9	75	265	492	560	980
D	8/-	100	375	700	780	1370
E	8/9	150	504	940	1100	1900
Ei	9/6	200	750	1350	1550	2700
F	10/3	300			2180	3800
G	12/-	500			3260	5600
H	14/-	750			4600	7800
I	16/-	1000			7700	12500
J	19/-	1500			12400	21500

ALL Gambrell Productions are of that first-class design and manufacture which it is now realised by all is essential for results above the ordinary. Write for particulars.

## GAMBRELL BROS., LTD.

76, Queen Victoria Street, London, S.W.1.

'Phone: Victoria 9938.



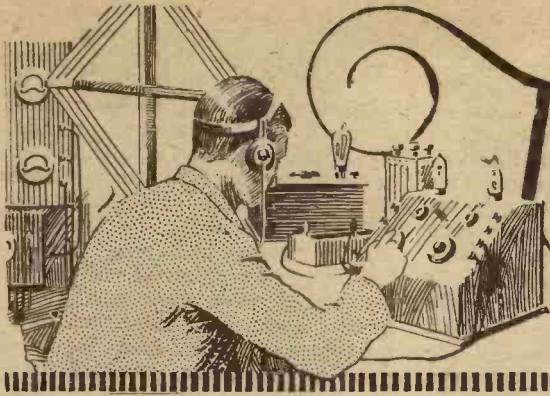

# Tested by Ourselves

**A Safety H. T. Battery**  
**M**ESSRS. E. NEEDHAM and Brcs., Ltd., have submitted a sample of their "Sigmax Safety Radio B Battery," a 60-volt H.T. unit incorporating a permanent high resistance in circuit at the negative end, with a by-pass condenser. The unit measures approximately 9 in. by 3 in. square, and has 11 tappings for wander-plugs, *i.e.*, at 6-volt intervals. This resistance, which proved to be of the order of 2,000 ohms, limits the maximum current, even with a dead short circuit, to an amount insufficient to damage the filament even of a .06 type of valve; whilst at the same time it is insufficient to produce any significant voltage drop in normal use, the condenser across it providing an H.F. by-pass of low impedance. On practical trial with a two-valve set, this was confirmed, and silent operation resulted. When used with a larger set, particularly with several stages of L.F. amplification, it would be advisable, as the makers wisely suggest, to put an additional 2  $\mu$ F fixed condenser across the battery, in case a tendency to howl (through the resistance in the battery) were observed. The resistance will, of course, cause the battery to show a fictitious low value of voltage when tested with a voltmeter not of the high-resistance type, unless the special "minus" tapping-point be used for this purpose. Using this special tapping, the battery under test registered a full 60 volts.

**Three-Coil Holder for Enclosed Cabinet Sets**

A large type of three-coil holder, particularly adapted for mounting at the rear of an American type of cabinet receiver with vertical panel, has been

submitted by Messrs. A. G. Parker and Co., Ltd. The two control handles have long spindles, and are intended to project out through the front panel, the actual mechanism and the coils themselves being well away at the back of the cabinet, thus both economising space and obviating hand capacity effects, since these spindles are insulated. The two moving coils have a sliding motion on long guide bars; and in addition have a movement of rotation determined by an ingenious combination of the rack-

resistance was excellent; and the largest sizes of coils could be handled with ease. Whilst the device is suitable only for cabinet receivers of fairly large dimensions, it gives one the impression of being built for long service and hard wear. The workmanship and finish are of a high class.

**"Felix" Crystal**

The "Felix" Crystal, which we are instructed by the makers "keeps on talking," did not belie its reputation when put to practical trial. This brightly granular crystal supplied by Messrs. Lawler Electric was found to operate well in an automatic detector in which hand-setting was quite ruled out, giving a large proportion of excellent sensitive settings of maximum rectification effect when compared with the general average of galena crystals, and proved very stable under an extreme test of loud reception on a large aerial close to a powerful station. Under favourable conditions distant stations could be distinguished. The crystal behaved in general just as a good galena crystal should behave, and can be recommended with confidence, judging from the sample submitted to us.

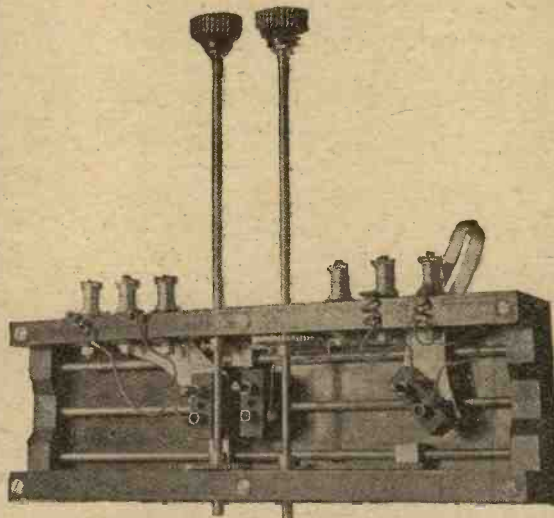

The three-coil holder made by Messrs. A. G. Parker and Co., Ltd.

and-pinion device which advances and withdraws them, the effect being that the coils are moved round at a position of minimum coupling to the fixed coil quite rapidly towards the end of their movement. Accordingly, a good control is obtained over coupling throughout their course. The whole apparatus is very substantially built, and was found to work smoothly and with a minimum of back-lash. Large terminals are provided, in an accessible position, and with stout flex connections to the moving coils. Insulation

**New Pattern P.M. Crystal Detector**

A sample of the latest pattern of their "Permanent" crystal-detector has been submitted by Messrs. Radio Instruments, Ltd. This is of the familiar two-crystal type, with the combination of a mineral resembling bornite with the yellow transparent substitute for the older zincite which appears in many of the semi-permanent detectors, and which gives, in practice, such



**Cabinets you want!**  
For Radio Perfection

**BEFORE YOU BUILD!**

It well repays (before you build) to get Pickett's Cabinet Estimate. Send to -

PICKETT'S CABINET WORKS (W.M.), Bexley Heath, S.E.

**THE RADIAX CATALOGUE**

**SUPER-HETERODYNE COMPONENTS**  
The new adjustable condensers, Frame Aerials, Low Loss Coils and whole range of accessories, large and small, catalogued.

**ENCLOSE 3d. STAMPS.**  
State if list of Receiving Sets—complete and for constructors—is also required.

**RADIAX LTD.**  
—Radio House, 40, Percy St., Tottenham Ct. Rd., London, W.1.



**DO—  
NOT  
FORGET!**

that on Sept 15  
the great new  
Radio Press  
Weekly

**WIRELESS**  
**THE ONE-WORD**  
**WEEKLY**

will be on sale  
at all Bookstalls

**Price 2d.**

**ORDER IN ADVANCE**

**RADIO PRESS Ltd.,**  
Bush House, Strand,  
London, W.C.2.

uniform and satisfactory results if properly set and carefully treated. The makers point out the necessity for avoiding unnecessary interference with the adjustment of the crystals, when a good setting has been found. The writer noted in a personal test of a recent pattern that very little rough treatment was needed to displace the crystals altogether. Such adjustment as is necessary should be made by gently lifting the adjusting knob which projects at the outer end of the fitting, turning it a short distance, and letting it drop back lightly; the crystals should on no account be ground together. In this latest pattern further protection has been given the crystals by the provision of a cap, with bayonet joint, to cover the small adjusting knob and spindle entirely. Another detail in improvement is also introduced in the single-hole fixing device; the nut securing the detector to the panel can be removed without affecting the adjusting handle. On trial, it was found very easy to fix as indicated, and the cap gave a neat finish as well as improved

noticeable tendency on the part of the single fine-adjustment plate to creep round when the main bank was being adjusted, as sometimes happens. A tension spring at the lower end provides for adjustment of the bearings; the absence of any shake and the smoothness of rotation were noticeable features. The usual one-hole-fixing device is incorporated; metal end-plates are fitted with very small and narrow insulating bushes, scarcely consistent with modern low-loss practice. However, provided that the insulation was quite dry, the insulation-resistance proved, on measurement, to be adequate; on breathing near the condenser this diminished noticeably, but slowly

The "Ideal" ball-bearing condenser, a report upon the performance of which is given below.

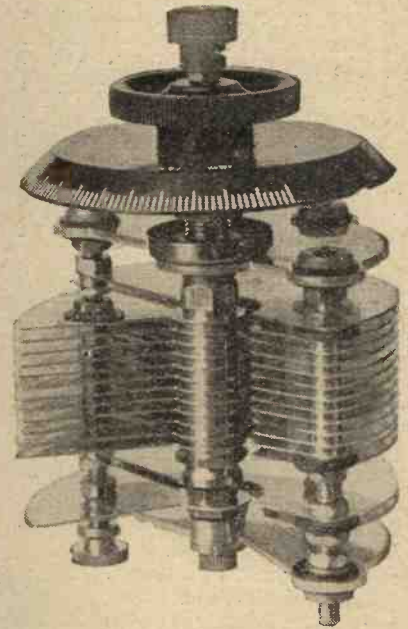

security for the crystals. On quantitative test in comparison with a standard galena type of crystal-detector, hand set, this detector gave an average on six fairly uniform consecutive settings of 21 microamperes, with the local station's carrier wave, as against 28 microamperes for the standard; a satisfactory figure for ordinary daily broadcast reception, where the hand-set galena rapidly deteriorates and is frequently worked at a low level of efficiency.

**"Ideal" Ball-bearing Condenser**

An example of a variable condenser in which a special effort had been made to obtain smooth operation by the provision of adjustable ball-bearings for the rotor, has been sent for our criticism by Messrs. R. McKellen and Co. The instrument submitted was of the square law, nominal .0005  $\mu$ F capacity type, with separate three-plate fine adjustment condenser co-axial with the main portion, and controlled by a small knob above the principal control knob. The ball-bearing between the two rotors renders them mutually independent; there was no

recovered on standing. No difficulty was experienced in obtaining oscillation on the ordinary short waves. The minimum capacity was rather on the high side, over 33  $\mu$ F; maximum capacity, .000535  $\mu$ F; capacity range of the three-plate fine-adjustment, 36  $\mu$ F. Large convenient terminals are provided, and the instrument is strongly constructed and well finished. Solid stops are arranged at each end of the rotor travel, and a good quality knob and bevel scale are provided. Care must be taken in adjusting the bearings not to cause the plates to touch, as the clearance is small.

**New Dubilier Condensers**

Two new patterns of their well-known small fixed condensers (for reception) have been issued recently by Messrs. The Dubilier Condenser



Co., Ltd., and samples have been submitted for test of the .0001- $\mu$ F size in Type 610 and of .001  $\mu$ F in the Type 620. The first is contained in a small flat moulded case with rounded ends and with the usual wax filling below; we were very glad to see the convenient screw terminals fitted to these, so essential for experimental work and for many home-constructors' use. Spring clips, which are detachable, are provided for grid-leaks, and the latter can thus be used in the series connection as well as in parallel with the condenser. The other type is in a narrow vertical moulded container suitable for mounting in a confined space behind the panel, drilled lugs being provided for No. 5 B.A. screws. Substantial terminal screws are provided in this case. Whilst these condensers were submitted to the usual routine tests, it is scarcely necessary to say here that they conformed to the usual high standard of Messrs. Dubilier's productions. We must congratulate Messrs. Dubilier on their foresight in providing thus for the needs of the inveterate experimenter and home-constructor, as well as for the professional radio set-builder.

**"Ravald" Mica Variable Condenser**

Messrs. John Moores and Co., have submitted for test a very light and compact type of 2-plate variable condenser, with partly mica and partly air dielectric. In this, a small panel, about 3 $\frac{1}{8}$  in. by 2 $\frac{3}{8}$  in., is mounted behind the main panel by the customary one-hole-fixing device, and carries two small terminals provided with soldering tags, together with the fixed and moving plates. The latter is of thin springy copper, and has a movement similar to that of the leaf of a book, being pulled shut against its own spring by a screw actuated by the control-knob projecting as usual in front. A thin sheet of mica is interposed, and becomes an important factor in determining the capacity when the plates are close together. On measurement of the minimum capacity it came out at about 9.5  $\mu$ F (and not zero as stated on the containing box); whilst the maximum available with the plates screwed reasonably tight up was .00054  $\mu$ F—materially less than that claimed by the makers. The

increase of capacity was very rapid towards the end of the adjustment, as is usual with mica-and-air two-plate condensers, the upper range being rather too abrupt for easy tuning. The insulation-resistance was satisfactory on test, and there were no signs of undue H.F. losses. For light portable sets, with a limited range of wavelength, this simple type of variable condenser offers obvious advantages.

**"L. & P." Filament "Vernier" Rheostat**

An interesting type of filament resistance which gives a really fine adjustment of filament temperature,

a right angle metal bracket carries a small insulating strip, on the further end of which is mounted a split contact-ring. Through the fixing-bush slides a shaft carrying the resistance solenoid, wound on a small insulating cylinder. A spring brush makes contact with the sliding shaft; whilst the contact ring mentioned completes the circuit *via* the resistance spiral. The knob is pulled out to decrease the resistance, and *vice versa*, a definite "off" position being provided when fully "in." As the number of turns of wire is large, and the contact elements make contact with more than one turn

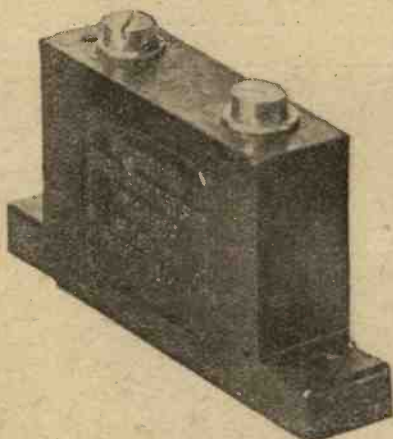

The Dubilier Type 620 fixed condenser

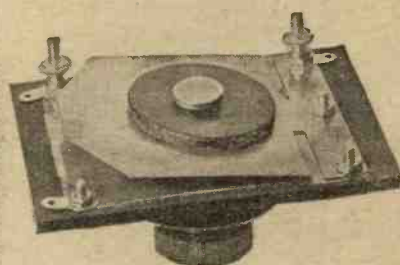

The "Ravald" Mica Variable Condenser



The "L. and P." Filament Vernier Rheostat

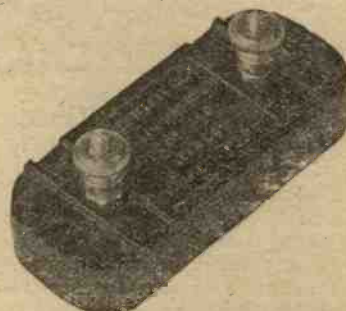

The Dubilier Type 610 fixed condenser

together with silent operation, and which at the same time occupies a minimum space on the panel is the "L. & P." Vernier Rheostat. This instrument is made in both D.E. (40 ohms maximum in the case of the sample submitted for test) and the bright-emitter types (6.5 ohms measured resistance); both have the same type of frame and mounting, and differ only in the resistance solenoid. A space of about 1 sq. in. is occupied on the panel; the exceedingly neat type of one-hole fixing device will accommodate panels up to a little over  $\frac{1}{4}$  in. in thickness. A thoughtful provision is that of a small key for tightening this fixing device, included with the unit. The design is simple but effective;

of the wire at a time, the operation is both refined and noiseless. The D.E. type is found to carry up to 0.35 amperes without undue heating, so that it is also suitable for controlling the modern small power-valve for L.S. operation; the bright-emitter type carried 0.6 amperes with ease, but got rather hot with 1 ampere; it is suitable for the R type of bright-emitter valve or the .4 ampere type of 2-volt small power valve.

Whilst a clearance of about  $\frac{1}{4}$  in. is required behind the panel, so small a space is actually occupied by these rheostats that the writer found it possible to replace an older type of carbon-compression resistance, in a complex and crowded experimental receiver, by two of



Tested by Ourselves—(Contd.)

these rheostats, the bright and dull-emitter types respectively in parallel, so as to provide the two available ranges with the complete silence characteristic of a good wire-wound resistance, and without any serious modification of the wiring, giving a most luxurious and convenient control for varied experimental work. The substantial and accessible terminals provided were appreciated when installing these instruments in a narrow space.

The rheostats appeared to be well-made (if a little on the light side) and neatly finished; they can be most heartily recommended for the broadcast listener and genuine experimenter alike. The makers, Messrs. London and Provincial Radio Co., Ltd., are to be congratulated on producing an effective and most useful component. We would like to see a really high-resistance potentiometer along the same lines.

An Unsatisfactory "Permanent Detector."

Samples of a new "permanent detector" have been received for test from E. Gwyther. These are mounted in an ebonite tube 2 in. long, with a substantial terminal at each end. On closer examination the sample dissected proved to be of a familiar type; a fragment of galena crystal and a cat's-whisker fixed in a (presumably) favourable setting by means of wax, and the whole sealed in the tube with plaster-of-Paris, or some similar material. The efficiency of this device depends evidently on the choice of the single setting and the certainty with which this can be maintained whilst assembling the unit; the permanence of the setting is measured by the life of a single setting of the whisker on a galena crystal, *i.e.*, in hours at the most for efficient service under practical broadcasting conditions. On actual trial, three out of the six samples submitted showed no rectifying powers at all, though in the case of the one dismantled the small fragment of crystal when removed showed normal behaviour on hand-setting of a whisker into proper contact with it; of the three which showed some activity two were distinctly poor; the other showed the same rectifying

efficiency as a standard hand-set galena.

We understand that this detector is to be marketed under the mark of "H.C.B. Permanent Detector." We regard this instrument as not merely of inefficient design but five out of the six samples were thoroughly bad, and on this test we can only advise readers to have nothing to do with it.

Loading Coil for 5XX

Messrs. Henry Josephs & Co., Ltd., have submitted a compact loading-coil, together with the necessary plug and socket for the panel. On trial it successfully loaded up an ordinary tapped inductance type of crystal-receiver so that 5XX could be received. The tuning was far from sharp, and the measured signal-strength was rather less than with a much larger coil and critical tuning. As a practical compromise in conjunction with an existing set in which extensive alterations, in order to provide the alternative range, are not desired, this compact loading-coil will have its uses.

AIRCRAFT WIRELESS

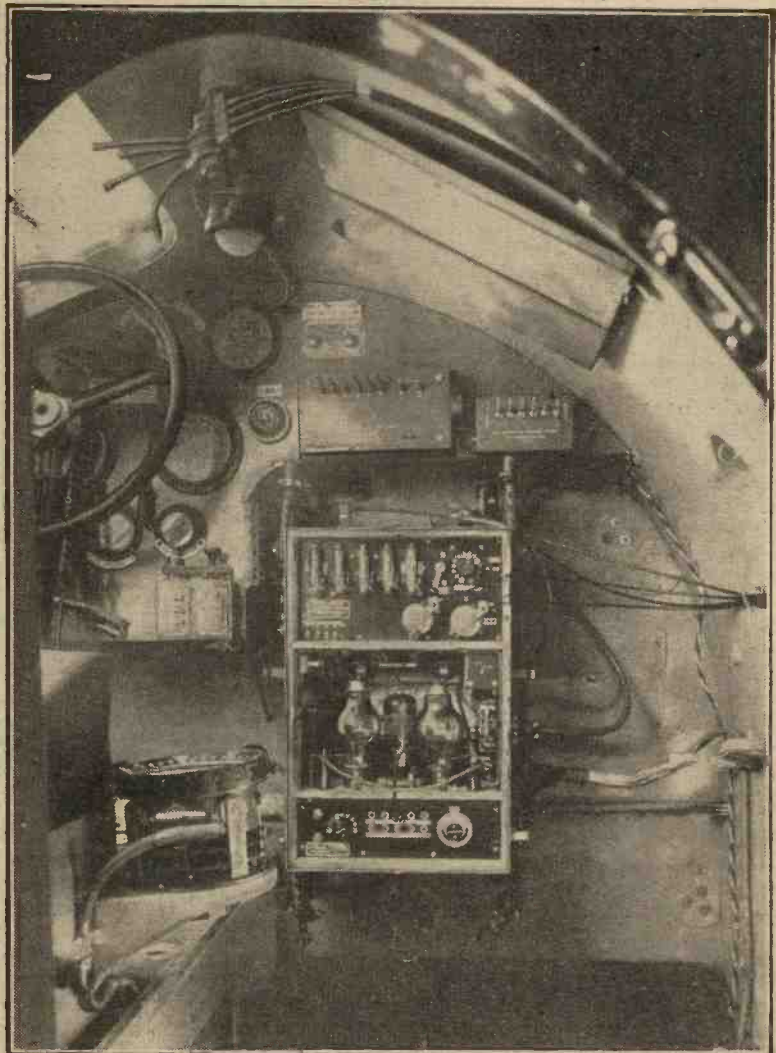

The Marconi 150 Watt aircraft set for telegraphy and telephony, fitted in an Imperial Airway passenger machine. This is the standard wireless installation for British commercial craft.



## Some Readers' Results with Radio Press Receivers

### A "Double-Circuit Neutrodyne" Receiver

SIR,—In reference to the "Double Circuit Neutrodyne" Receiver by Mr. John Underdown, described in the November, 1924, MODERN WIRELESS, I wish to let you know how pleased I am with the results.

I have been using this receiver for a considerable time, and have received all the B.B.C. main stations and Edinburgh Relay at comfortable strength. I live about three miles from 2BE, which comes in well at loud-speaker strength.

When 2BE is working, I can eliminate it and get 2LO, 6BM and 2ZY. The receiver is excellent for long distance telephony, having picked up on numerous occasions F.P.T.T., Hamburg, Leipzig, Breslau, Munich, Münster, Rome, Voxhaus and Madrid, the latter being at good volume.

Some time ago I picked up a station transmitting orchestral items, and vocal selections by a soprano on a wavelength of about 380 metres, but owing to atmospheric conditions I could not catch the call sign.

My aerial is 110 ft. long supported at the free end by a 45 ft. mast; ground connection being a buried zinc plate with a 5-ft. lead. I consider the results obtained excellent, and congratulate Mr. John Underdown on his design.  
—Yours truly,

NORMAN A. MACLEOD.

Belfast.

### The Transatlantic Receiver in India

SIR,—I have much pleasure in informing you that some time ago I constructed the "Transatlantic Receiver" described in the November, 1923, issue of MODERN WIRELESS, by Percy W. Harris, which is giving me excellent results.

Besides the two broadcasting stations we have at present in India (5AF—Calcutta, 160 miles and 2FV—Bombay, about 900 miles from here), I have received three B.B.C. and one French station.

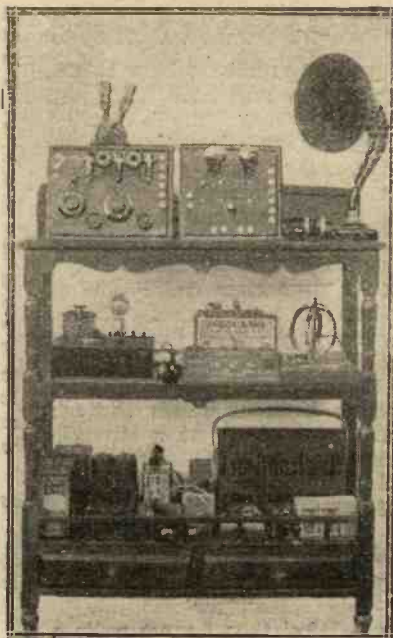

Mr. S. P. Roychowdhury's Apparatus.

One night I was able to tune in as many as seven European broadcasting stations.

I should like to mention before concluding that in India the popularity of radio is only passing its infant stage of development, and the Radio Club of Bengal, Calcutta, which was the first to pick up B.B.C. stations, is the pioneer of its type in India. I enclose herewith a photograph of some of my wireless apparatus. A Modified "Flewelling-Super" and Mr. A. D. Cowper's "Really Loud Crystal Set" can be seen below the Transatlantic receiver.

Wishing your three excellent magazines the success they deserve.

—Yours truly,

S. P. ROYCHOWDHURY;

Indian 2EX.

Terasri, Dacca Dist., Bengal, India.

### The Transatlantic V. in Egypt

SIR,—Some time ago I built the above receiver as described by Mr. Percy W. Harris in MODERN WIRELESS for June, 1924; now I write with a view to telling you of the results obtained. Since completion I have changed the variable condensers from cheap unknown makes to "Square Laws" and the difference made has to be

experienced to be realised. Signal strength is at least 50 per cent. better, and the various wavelengths are widely spaced on the scale, although I find the A.T.C. setting is not critical. Fitting these condensers gave me a very good example of the worth of your recommendation of fitting good quality parts only. Stations that have been definitely identified by their call signs are as follows, but I have had music and speech from many others: Rome, Newcastle, Bournemouth, Breslau, Münster and London. I have had Chelmsford, but have not heard him give his call sign. Time signals from Eiffel Tower also come in well. A week or so ago I borrowed a loud-speaker and was agreeably surprised to find that Newcastle and Bournemouth could be clearly heard three rooms away, while speech and the announcer giving out the items of the programmes and the news bulletin were clear and distinct in the room where the loud-speaker was situated. It was from one of these stations (I was too engrossed to remember which) that I received Luigini's "Ballet Egyptien" as clearly as if I was in England. This was without the help of any special H.T. or power valves, with only the normal H.T. on the plate of the 2 H.F. and detector with 60 volts on the 2 L.F. valves and with the reaction coil socket shorted. I find that the set is very critical on the filament adjustment and could almost do with vernier rheostats on the first three valves. Taking the atmospheric conditions out here and the distance into consideration I think Mr. Harris is to be congratulated on evolving this set. In any case I extend to him my best thanks for many pleasant evenings (or should it be mornings!) entertainment. Cairo will soon have a representative display of Radio Press sets, as two friends of mine are about to construct the Anglo-American Six and the Seven-Valve T.A.T.—Yours truly,

F. A. SHEPHERD.

Cairo, Egypt.



**A Useful Single-Valve Receiver**

SIR,—With reference to MODERN WIRELESS, February, 1925, re the single-valve receiver described by John Underdown. You will be interested to hear that, being an experimenter in wireless myself. I have built up this remarkable little set. I found it to answer to all you state in the issue and am delighted with the results obtained. I have received most of the B.B.C. stations on it, also several German, and also 5XX, all at really good strength. Further, a single-valve set was brought to me to put in order, but I was so disgusted with it that I advised my friend to let me rebuild it for him, and to try this receiver, and the result is, he is satisfied. I think this speaks well for the design, and I must wish MODERN WIRELESS every success.—Yours truly,

S. SMELT.

Scarborough.

**The All-Concert Receiver**

SIR,—I must thank you for the splendid "All Concert Receiver" described by Mr. Percy W. Harris in MODERN WIRELESS, September, 1923. I am more than satisfied.

Some Further  
Readers' Letters

I regularly receive all the B.B.C. stations, Newcastle, Aberdeen and London, on a "Baby" Sterling loudspeaker, and the other stations on 'phones at good strength, especially Bournemouth, Cardiff, Birmingham, Glasgow and Manchester. I also receive concerts regularly from Eiffel Tower, Radio-Paris, L'Ecole Superieure des Postes et Telegraphes, and Brussels. Many amateurs have been logged from London, Birmingham, Manchester, Sheffield, etc., etc. One local Tyneside amateur comes through on the loudspeaker at a strength nearly equalling 5NO. WCY and WJZ have been heard on three occasions.—Yours faithfully,

JAS. GRANT.

Felling-on-Tyne.

**An interesting Valve-Crystal Receiver**

SIR,—I feel that I must write a

few words in praise of the "Interesting Valve-Crystal Receiver" as described in the May, 1925, issue of MODERN WIRELESS, by Harold H. Warwick. I have constructed a set on a base-board, using this circuit, and not in a cabinet. It is only wired up roughly, and yet it gives splendid results. I did not expect such a number of stations. I have so far received and identified the following:—Birmingham (100 miles), Cardiff (150 miles), London (100 miles), Nottingham (100 miles), Sheffield (80 miles), Leeds (90 miles), also Manchester and Newcastle, and, of course, Daventry (about 90 miles); the latter comes in on the loudspeaker ("Dragonfly"). I have also heard several foreign stations at good strength, among them Petit-Parisien and Radio-Paris (300 miles). You will notice that I am a long way from the nearest station, and it was with some doubt that I wired up the set.

My aerial is about 70 ft. long and 25 ft. high, unscreened.

Hoping this will be useful and of interest to other readers,—Yours faithfully,

KENNETH H. ROBINSON.

Friskney, Lincs.

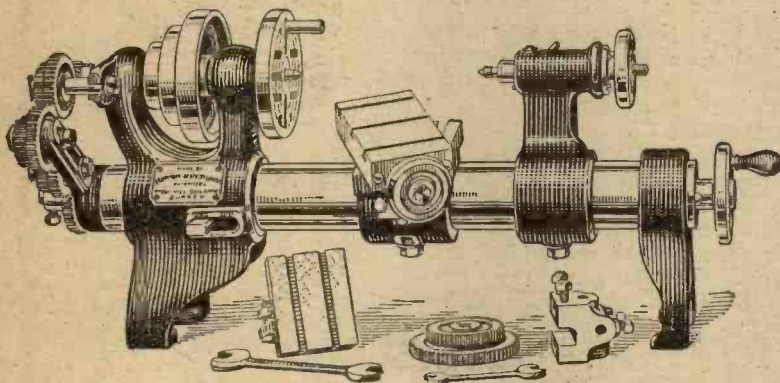

**Amateurs!**

For over twenty years the most beautiful work has been accomplished by experimenters, model engineers—enthusiasts all—possessing Drummond Lathes. These handy tools cover such a wide range of work, from wireless parts to car repairs, model making to full scale engines. Why not develop your own skill?

For the homemaker the handiest of all lathes in every respect is the DRUMMOND

**4-inch Universal Lathe**

Illustrated lists giving full details, post free

**DRUMMOND BROS., LTD.,**

Reid Hill, Guildford

**Peerless in name and in performance**



Size, 1 1/2 in. dia., 1/2 in. high  
6, 15, or 30 ohms.

2/6

As soon as you use the "Peerless Junior" Rheostat you will find it gives the full degree of faultless service that the name implies. The resistance element is immune from damage and will safely carry the current of two valves. An off position is provided and definite stops are so arranged that it is impossible for a short circuit to occur. Complete, with handsome engraved nickel dial and one-hole fixing. Made in three types.

From your dealer, or  
THE BEDFORD ELECTRICAL & RADIO CO., LTD.,  
22, Campbell Road, Bedford.

**CABINETS CAMCO CASEWORK CABINETS**

**WRITE AT ONCE** for our illustrated list of 100 varieties of cabinets for radio sets, including many described in "MODERN WIRELESS," "WIRELESS WEEKLY," and "WIRELESS CONSTRUCTOR," etc., or 'phone Clerkenwell 6903.

NAME.....  
ADDRESS.....

Write in Block Letters Please.

.....  
Cut along here and post in unsealed envelope bearing 1d. stamp.  
TRADE ENQUIRIES ESPECIALLY INVITED.  
**CARRINGTON MANUFACTURING CO., LTD.**  
18/20, Normans Buildings, Mitchell St., Central St., E.O.I





# NEUTRON

TRADE MARK REGD.

The World's Greatest Radio Crystal

## "This Super Crystal"

"Your advert. in . . . on the 14th of March, certainly proves the value of the contents of one of those small boxes NEUTRON."

"I thank sellers of this super crystal—having tried every crystal I have seen, I claim Neutron to be the Crystal."

Testimonial No. 776.

The Crystal with Valve Power

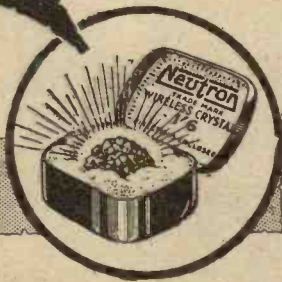

Ask your Dealer for it or send P.O. for 1/6 together with your Dealer's address, and one of these wonderful crystals will be mailed you by return.

**NEUTRON DISTRIBUTORS,**  
Sentinel House,  
Southampton Row, London, W.C. 1.  
Phone: MUSEUM 7560.

A product of **NEUTRON LTD.,**  
Sent nel Ho., Southampton Row, W.C.1.

# SILVERVOX



The Silvertown "Silvervox" Loud Speaker will reproduce both speech and music without the loss of its original tone and quality. Coils wound to either 120 or 2,000 ohms. The tone arm is a heavy aluminium casting. Total height, 20 inches. Size of trumpet 12½ inches diameter.

PRICE £3 10 0 each.

## TELEPHONE HEADPIECES

The "Stalloy" diaphragms are matched so as to secure a balance of tone and quality. Resistance from 120 to 12,000 ohms. Price (4,000 ohms) 20/- each.



## CRYSTAL HOLDERS

Mounted on ebonite base (3 ins. by 2 ins.) with glass tube to protect crystal from dust. The cat's whisker is of silver wire. A feature of this crystal holder is that it can be easily taken to pieces and set up again.

PRICE 4/- each.

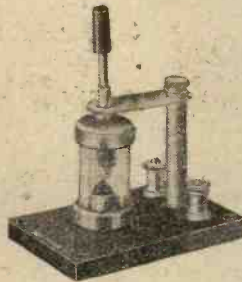

MAKERS :

## THE SILVERTOWN COMPANY

106, CANNON STREET, LONDON, E.C.4.

Works : SILVERTOWN, LONDON, E.16.

BELFAST : 75, Ann Street.  
BIRMINGHAM : 15, Martineau Street.  
BRISTOL : 4, Victoria Street.  
CARDIFF : Pier Head Chambers, Bute Docks.  
DUBLIN : 70, Middle Abbey Street.  
GLASGOW : 15, Royal Exchange Square.  
LEEDS : 1, New York Road.

LIVERPOOL : 54, Castle Street.  
LONDON : 100 and 102, Cannon Street.  
MANCHESTER : 16, John Dalton Street.  
NEWCASTLE : ON - TYNE : 59, Westgate Road.  
PORTSMOUTH : 49, High Street.  
SHEFFIELD : 88-90, Queen Street.





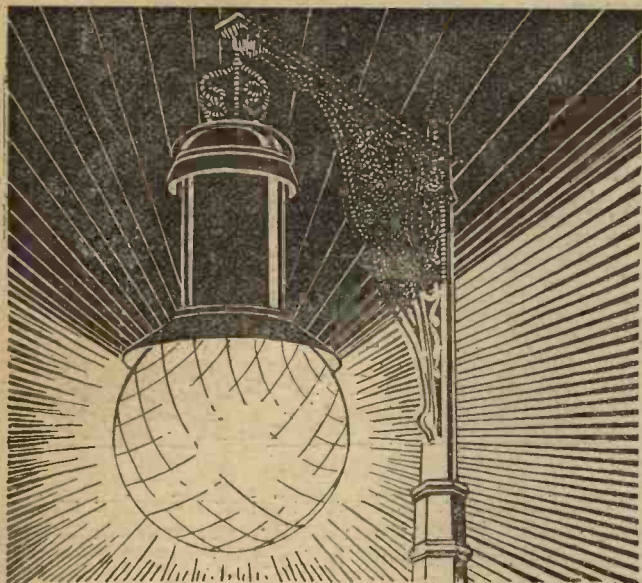

**The Arc Light —  
a comparison with the Grid Leak.**

YOU of course are familiar with the arc light. You've heard the hissing sound peculiar to it when in action. Have you noticed a similar noise when operating your radio receiver —the Grid leak is the cause!—Grid leaks made of carbon, graphite or impregnated paper are totally unsuitable for the pure reception of broadcast, for this reason. If examined under the microscope, such grid leaks look like so much coarse sand paper, and when current passes through them a minute arcing effect occurs. This is too small to be seen, of course, but it makes itself felt by setting up a hissing, rushing noise, that completely spoils the reception of signals.

This noisy background can be entirely eliminated, if the "Bretwood" Variable Grid Leak is used. It is constructed of such material that current flow is perfectly smooth and uninterrupted although it provides a high steady resistance.



Bretwood Grid Leaks are obtainable from all Wireless Dealers.  
**PRICE 3/-, Post free 3/2**  
With Condenser (as illustrated), 4/6, Post free 4/9.

Write for details of the Bretwood Valve Holder—Switch—and the new Bretwood Filament Resistance for Bright or Dull Emitter Valves.

**BRETWOOD LTD.**

12-18, London Mews,  
Maple St., London, W.



Barclays Ad.

**A New Battery  
OF  
OUTSTANDING MERITS**

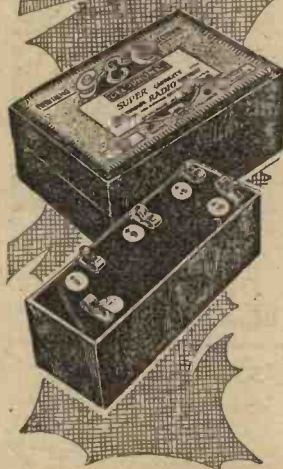

The new **GECOPHONE** Super capacity H.T. Radio Batteries have been specially designed to meet the needs of users of valve sets who desire to improve reception and to eliminate the annoyance of frequent renewals and the "sizzling" hitherto experienced.

**LONG LIFE**—4 to 5 times as long as others.

**LARGE CAPACITY.**

**SILENCE IN USE.**

These merits are worth your consideration. Ask your dealer about them.

**BRITISH MADE:**



Super Capacity High Tension **RADIO BATTERIES**  
Prices from 7/6 to 27/6

Sold by Wireless and Electrical Dealers everywhere.  
Manufacturers—The General Electric Co., Ltd., Magne' House, Kingsway, W.C.

FROM ALL WIRELESS DEALERS.  
SOLE DISTRIBUTORS, United Kingdom:  
**THE WHOLESALE WIRELESS CO.,**  
103, FARRINGTON ROAD, LONDON, E.C.

Colonies and Dominions:  
**A. VANDAM,** CAXTON HOUSE,  
WESTMINSTER, LONDON, S.W.



# Why not wind your own coils?

## "TUNING COILS AND HOW TO WIND THEM" BY

G. P. KENDALL, B.Sc.

This useful Radio Press book provides the radio enthusiast with a wealth of information on Tuning Coil Winding. With its assistance you will find coil winding an entrancing hobby and a fine way of constructing really efficient coils. The instructions given in the book are clear and simple. Simple tables show how many turns of wire should be wound for all the important wavelengths, thus enabling the enthusiast to produce coils of accurate dimensions for the stations he wishes to receive, obviating waste of wire and resource to mathematical calculations.

Obtainable from all Bookstalls, Newsagents, your local wireless dealer or direct from Dept. M.



**RADIO PRESS, LTD.,**

BUSH HOUSE,  
STRAND, LONDON, W.C.2.

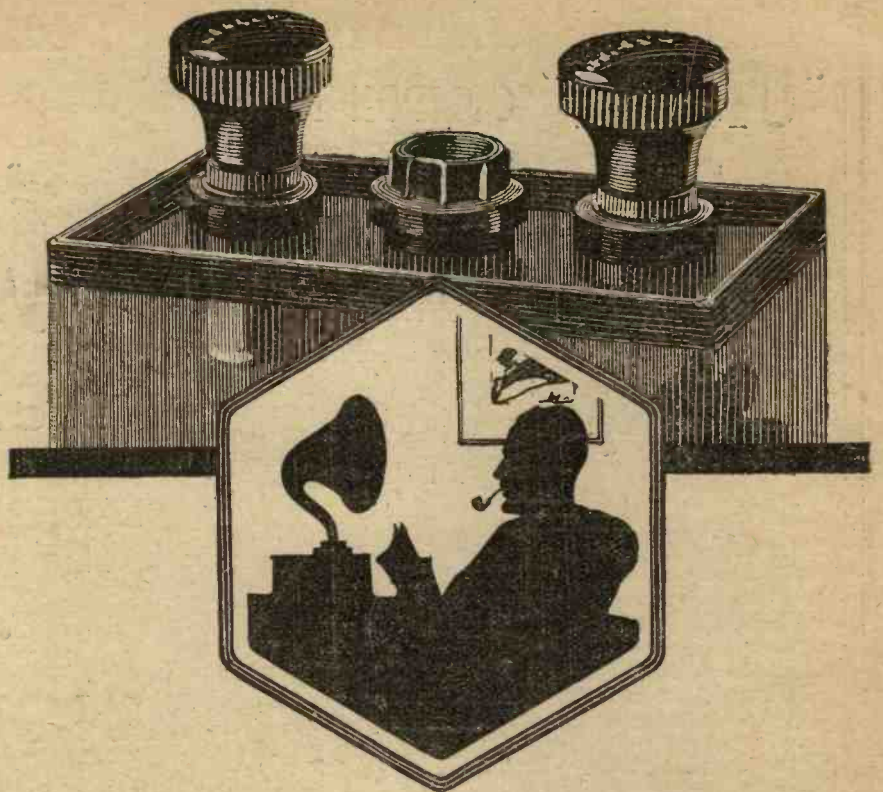

## For economy's sake you'll choose this Oldham

A **CHEAP** accumulator is about the most expensive thing you can buy. Not only will it have a short life, but it will require much more frequent recharging. And should it stand idle for any length of time much of its charge will disappear.

Oldham accumulators are built to give long service. Not only does this mean long life—it means also the ability to hold a charge for a much greater period. Their secret of success lies in their plates. All Oldham plates are made under the exclusive Special Activation Process—a method of plate making which automatically guarantees an exceptionally tough plate, capable of readily withstanding sulphation and buckling.

Examine an Oldham at your Dealer's. Note its strong case made from the best celluloid it is possible to obtain. If you have had experience with the leaky, flimsy cases of cheap accumulators you'll be glad to handle an Oldham and to see its immense strength.

You will also observe that its large filler cap screws into the top and that no acid can leak out. Its terminals, too, are of generous diameter, one being red and the other black to indicate polarity.

Altogether this Oldham Accumulator is splendidly made and well worth the moderate price asked for it. Available in a wide range of capacities in 2-volt units at all first-class Wireless Dealers.

**OLDHAM & SONS LTD., DENTON, MANCHESTER**

London: Hazlitt House, Southampton Buildings, W.C.2  
Glasgow: 120 Wellington Street





# "UTILITY" COMPONENTS

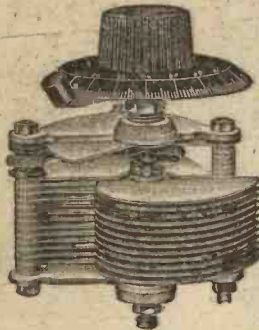

WM 124

## "UTILITY" CONDENSERS

Scientifically Designed, with Close Spacing, Large Adjustable Bearings and Perfect Insulation.

### PRICES :

SQUARE LAW OR ORDINARY PATTERN.

No. WM 123 .001 ...	Each	12/6
No. WM 144 .00075 ...	...	11/9
No. WM 124 .0005 ...	...	10/6
No. WM 125 .0003 ...	...	8/9
No. WM 145 .0002 ...	...	7/9
No. WM 146 .0001 ...	...	7/6

Vernier 2/6 extra. Flitted with Radion Dials.

By means of the "Utility" Coil Changing Unit, instant switching from one station to another can be effected. It is attached to the inside of the panel by our usual method of one-hole fixing. As the illustration shows, it is only necessary to plug in coils in the ordinary way, No. W 155. Price 7/6 each

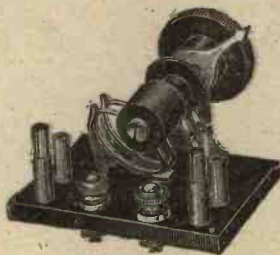

WM 155

The "Utility" Crystal Detector is the outcome of exhaustive experiments with the object of producing a detector to obtain perfect results. By slowly turning the knob the catswhisker is advanced and withdrawn in turn and the crystal revolved, in such a way that the whole of its workable surface is explored.

Black bronzed, and with the usual "Utility" one-hole fixing

### PRICES :

No. W 155 ...	7/6 each.
No. W 153 ...	8/- ..

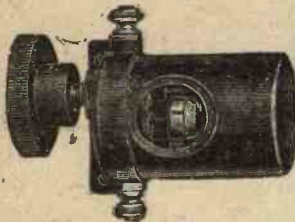

WM 153

## A NO-CAPACITY LEVER SWITCH

Contacts that clean themselves— are incorporated in the Utility NO CAPACITY Switch. Designed for use in radio-frequency circuits, it is the only switch which can be used with safety. Obtainable with lever or knob and pointer.

### PRICES :

	With Lever. each	With Knob. each	
1 pole c/o,	4/6	1 pole c/o, 3/4	
2 "	5/-	2 "	4/-
3 "	6/-	3 "	5/-
4 "	7/6	4 "	6/-
5 "	10/-	5 "	7/-
6 "	10/-	6 "	8/-

N.P. 6d; extra. N.P. 3d. ea. extra.



WM 147/2

"Utility" for Efficiency

Manufactured by

**WILKINS & WRIGHT, LTD.**

UTILITY WORKS, KENYON ST., BIRMINGHAM.

AGENTS:—AUSTRALIA: A. E. ACKLAND, ZIG, ROYAL ARCADE, SYDNEY.  
MALTA: MUSCAT'S GENERAL STORES.  
BELGIUM: WARNES & LEWIS, 72, RUE-DE-LA-SOURCE, BRUXELLES.  
HOLLAND: VAN SANTEN & CO., DEN TEXSTRAAT 22, AMSTERDAM

# The Latest Wireless Handbook

for the  
EXPERIMENTER, ENGINEER,  
AND RESEARCH WORKER.

## "RADIO ENGINEERING"

By

J. H. REYNER, B.Sc. (Hons.), A.C.G.I.,  
D.I.C., Staff Editor of "Wireless Weekly,"  
"Modern Wireless" and "The Wireless  
Constructor."

A Complete Library of Technical In-  
formation, Valuable Scientific Data and  
Reference Tables in one Handy Volume,

**NOW ON SALE.**

**YOU CAN OBTAIN "RADIO  
ENGINEERING" ON 5 DAYS  
APPROVAL.**

Fill and post this form to-day.

5 DAYS APPROVAL ORDER FORM.

To Radio Press Ltd.,  
Bush House, Strand, London, W.C.2

Please supply me/us with ..... copies of the new handbook "RADIO  
ENGINEERING" on 5 days approval, after which period, I/we either  
return same, undamaged, or remit ..... purchase price,

Name.....

Address.....

Radio Engineering  
Published Price 15/-  
(Post Free 15/9)



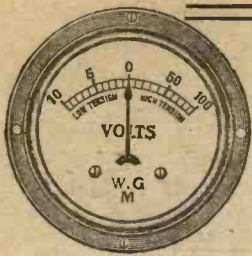

**"Goltone" Double Range Centre Zero, Panel Mounting Voltmeter.**

British made. Patent applied. Diameter of Flange 2 1/2 ins. Is your Accumulator fully charged? Is your H. T. Battery run down? The "Goltone" centre zero panel mounting instrument answers these important questions. The meter indicates by pressing a push-button connected in the circuit the state of voltage of your high and low-tension batteries.

Price 12/9

2-panel mounting push-buttons for use with above 1/6 pair. To ensure the genuine instrument insist on our initials or Trade Mark on Dial.

**Purity of Tone, Volume without Distortion.**

These are the characteristics of the "Goltone" Low Frequency Transformer which make it the choice of all experienced Constructors. Recommended in any circuit with any type of Valve. No make of Transformer gives better results. Ratio 2 to 1 and 5 to 1.

Price 17/6



**"GOLTONE" HIGH FREQUENCY TRANSFORMERS**

High-grade Precision Instruments wound on solid Ebonite Formers.

No.	Metres.	Price
R12/60	80-150	7/-
R12/61	150-300	
R12/62	300-600	
R12/63	600-1,200	
R12/64	1,200-3,000	

Each Specially wound Neutrodyne Model covering 350-550 Metres. Price 7/-



**HIGH TENSION WANDER PLUGS**



**EASIFIX**

**HIGH AND LOW TENSION ASSEMBLY.**

Length overall 64 ins. Eliminate all ugly loose wiring and minimises the risk of burning cut valves. Each conductor is distinctively coloured and enclosed within an outer braiding. Complete with Wander Plugs. Price 3/- With Extra High Tension Lead. Price 4/-.

**64 IN LONG OVERALL**

**TO HIGH & LOW TENSION PANEL TERMINALS.**

Supplied also with extra High Tension and Grid Bias leads.

**THE "TRIPART" TERMINAL.**

Will securely clamp Telephone Cord Pins and Spade Terminals. It is also drilled down centre to take standard Wander Plug, and can be used with advantage for all Wireless connections.

Price 3d. each 2/9 doz.

**"GOLTONE" SPRING PLUG.**

Ensures a perfect connection eliminating all noises due to imperfect contacts. Fits into the standard High Tension Battery and the "Tripart" Terminal listed above. Supplied with Black and Red tops. Price 2 1/2d. each 2/3 doz.

Stocked by the Leading Radio Stores. Write direct if unobtainable.

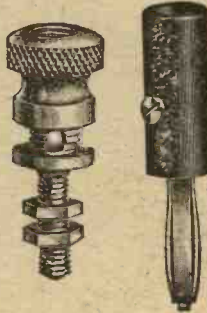

Large illustrated 36 pp. Radio Catalogue, No. R112, post free on request. Enclose Business Card for Trade Terms.

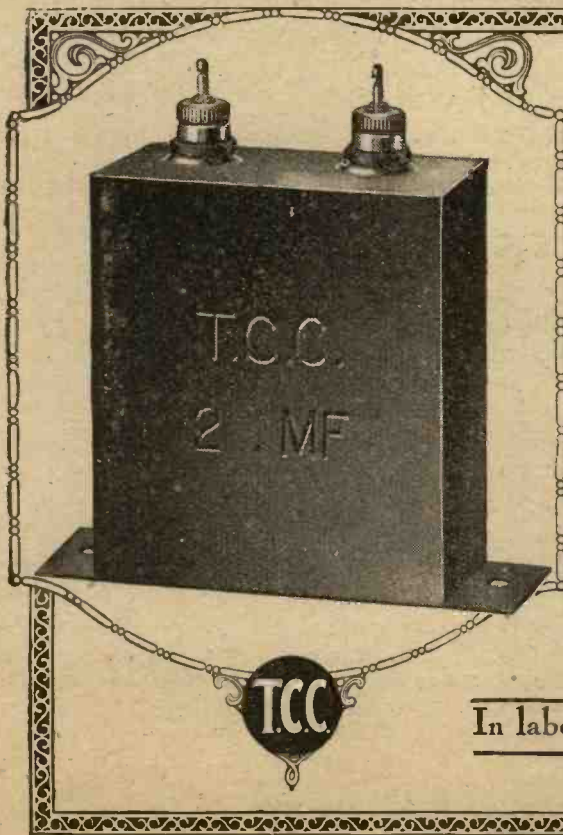

**The new improved T.C.C. Mansbridge**

**I**N Radio—the youngest and most virile of our industries—progress is essential. While it has not been found possible to improve the accepted principles of the Mansbridge Condenser—recognised as the standard large capacity condenser throughout the world—we have found it practicable to improve the famous green T.C.C. Mansbridge in certain important constructional details.

The new Duplex terminals (patent applied for) can be used as soldering tags or to hold connections by means of their knurled heads. The top of the Condenser is now *all-metal* which is, of course, quite impervious to the heat of the soldering iron or the action of the atmosphere.

T.C.C. Mansbridge Condensers are made in the largest factory in this country solely devoted to the manufacture of condensers. They are backed by a twenty-year old reputation for accuracy and dependability. They are fully guaranteed and British made throughout. Every Wireless Dealer stocks them in a wide range of capacities.

**In labour, design and material—British throughout**

Advertisement of Telegraph Condenser Co. Ltd., Kew, Surrey.



# Good Loud-Speaker Results with Two Valves!

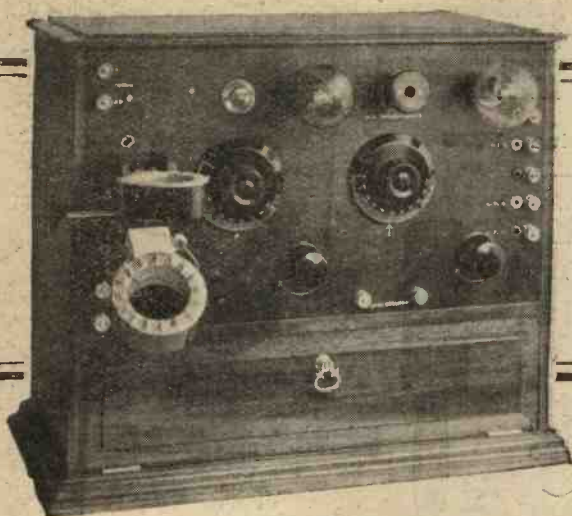

RADIO PRESS ENVELOPE NO. 10.

— How to Make —  
**The "Twin-Valve" Loud-Speaker Receiver**

By

JOHN SCOTT-TAGGART, F.Inst.P., A.M.I.E.E.  
 Editor of "Wireless Weekly" and "Modern Wireless."

**"Radio Press Envelopes make set building easy"**

Building a Radio Set to Radio Press specifications is an absolutely foolproof operation and will afford you great pleasure.

You cannot go wrong, and the finished set will work and look as if it had been made by an expert.

Radio Press Envelope No. 10 contains all details for constructing the "Twin-Valve" Loud-Speaker Receiver. It includes, as well as the fullest instructions, two full-sized blue-prints, three sheets of reproductions of photographs on art paper and three sheets of working drawings.



The "Twin-Valve" Loud-Speaker Receiver is undoubtedly the set for the man who desires good loud-speaker results from the local stations with the minimum of valves.

It will operate a loud-speaker at distances up to 25 miles from the local station with an aerial system of average efficiency. Two valves only are employed, the first valve functioning as a dual high and low frequency amplifier and the second as rectifier. The use of a crystal is thereby avoided, ensuring all the advantages of a reflex circuit with perfect stability of adjustment. The "Twin-Valve" has an ease of control characteristic of good reflex circuits and a handsome appearance which should please the most fastidious of set builders.

Dull Emitter or Bright Emitter valves can be used. For those who live in remote places the Dull Emitter type are recommended, as they save frequent excursions to the nearest accumulator charging plant.

ASK FOR RADIO PRESS ENVELOPE NO. 10.

Obtainable from all Bookstalls, Newsagents, your local Wireless Dealer or direct from Dept. M.

**Radio Press, Ltd.**  
 BUSH HOUSE, STRAND, LONDON, W.C.2.



**“They thought  
it was sheer luck”**

*that my set always worked  
“according to plan” when  
I was demonstrating its  
qualities to a party of  
friends.*

It isn't. The truth is, I always keep my set up to the mark, never allow it to get “run down”; and wireless sets, like us humans, are prone to slight and serious ailments.

When any symptoms of disorder manifest themselves in my set, I immediately look up that useful Radio Press book, “Wireless Faults and How to Find Them.”

It shows you how to get at the root of the trouble quickly and rectify it. Every enthusiast should possess a copy; it's a ready medium of trouble tracing.



**1/6**

POST FREE

1/8

You can obtain “Wireless Faults and How to Find Them” from all Bookstalls, Newsagents and Wireless Dealers, or post free, 1/8, from Dept. M.

**“Traces Trouble.”**

**Radio Press, Ltd.**

BUSH HOUSE, STRAND, LONDON, W.C.2.



# UNPARALLELED THROUGHOUT THE WORLD

**T**HERE is no better way of obtaining that knowledge, essential to success in set construction, and set manipulation, than by Radio Press Books and Publications.

Here, indeed, are radio books of an entirely different character. The average enthusiast will appreciate the concise and simple way difficult things are explained. No technicalities to puzzle one's head over, just as if the author was personally directing you.

The exceptional radio talent possessed by the Radio Press Editorial Staff ensures that all Radio Press publications are technically accurate.

The Radio Press system of Envelopes is a method that eliminates all possibility of error, that ensures a receiver perfectly built, and simple to operate.

They contain all the instructions necessary, with many illustrations and diagrams. Just as if you had the actual set in front of you.

## Radio Press Books

No.	Price	Post Free	No.	Price	Post Free
1	9d.	11d.	13	2/6	2/8
1 <b>Wireless for All</b> By John Scott-Taggart, F.Inst.P., A.M.I.E.E.					
2	1/-	1/2	14	2/6	2/8
2 <b>Simplified Wireless</b> By John Scott-Taggart, F.Inst.P., A.M.I.E.E.					
3	1/6	1/8	15	3/6	3/10
3 <b>How to Make Your Own Broadcast Receiver</b> By John Scott-Taggart, F.Inst.P., A.M.I.E.E.					
4	1/-	1/2	16	2/6	2/8
4 <b>How to Erect your Wireless Aerial</b> By B. Mittell, A.M.I.E.E.					
5	1/8	1/8	17	2/6	2/8
5 <b>The Construction of Wireless Receiving Apparatus</b> By P. D. Tyers.					
6	1/6	1/8	18	1/6	1/8
6 <b>The Construction of Crystal Receivers</b> By Alan L. M. Douglas					
7	2/6	2/8	21	1/6	1/8
7 <b>How to Make a "Unit" Wireless Receiver</b> By E. Redpath					
8	1/6	1/8	22	1/6	1/8
8 <b>Pictorial Wireless Circuits</b> By Oswald J. Rankin					
9	2/6	2/8	24	1/6	1/8
9 <b>Wireless Valves Simply Explained</b> By John Scott-Taggart, F.Inst.P., A.M.I.E.E.					
10	2/6	2/8	Elementary Text Book on Wireless Vacuum Tubes .. 10/-10/6		
10 <b>Practical Wireless Valve Circuits</b> By John Scott-Taggart, F.Inst.P., A.M.I.E.E.					
12 <b>Radio Valves and How to Use Them</b> By John Scott-Taggart, F.Inst.P., A.M.I.E.E.					
By John Scott-Taggart, F.Inst.P., A.M.I.E.E.					
By Percy W. Harris, M.I.R.E.					
By G. P. Kendall, B.Sc., and E. Redpath.					
By Percy W. Harris, M.I.R.E.					
By John Scott-Taggart, F.Inst.P., A.M.I.E.E.					
By E. Redpath					
By G. P. Kendall, B.Sc.					
By Stanley G. Rattee, M.L.R.E.					
By Oswald J. Rankin					
By R. W. Hallows, M.A.					

## Radio Press Envelopes

No.	Price	Post Free
1	1/6	1/9
1 <b>How to Build an ST100 Receiver</b> By John Scott-Taggart, F.Inst.P., A.M.I.E.E.		
2	2/6	2/9
2 <b>How to Build the "Family" 4-Valve Receiver</b> By Percy W. Harris, M.I.R.E.		
3	2/6	2/9
3 <b>How to Build the "Simplicity" 3-Valve Set</b> By G. P. Kendall, B.Sc.		
4	2/6	2/9
4 <b>How to Build the All-Concert de Luxe Receiver</b> By Percy W. Harris, M.I.R.E.		
5	2/6	2/9
5 <b>How to Build the Omni Receiver</b> By John Scott-Taggart, F.Inst.P., A.M.I.E.E.		
6	1/6	1/9
6 <b>How to Build the ABC Wave Trap</b> By G. P. Kendall, B.Sc.		
7	1/6	1/9
7 <b>How to Build a 2-Valve Amplifier de Luxe</b> By Herbert K. Simpson.		
8	1/6	1/9
8 <b>How to Make a 1-Valve Reflex Receiver</b> By Herbert K. Simpson.		
9	1/6	1/9
9 <b>How to Build an Efficient Single-Valve Set</b> By Herbert K. Simpson.		
10	2/6	2/9
10 <b>The Twin-Valve Loud-speaker Receiver</b> By John Scott-Taggart, F.Inst.P., A.M.I.E.E.		
11	1/5	1/9
11 <b>An Adaptable Crystal Set</b> By Percy W. Harris, M.I.R.E.		

## Radio Press Panel Cards

No.	Price	Post Free
1	1/-	1/3
1 <b>How to Make the W1 Receiver</b> By Herbert K. Simpson.		

## Radio Press Panel Transfers

	Price	Post Free
Large Packet of 80 Labels	6d.	8d.

## "Modern Wireless" Coil Table

	Price	Post Free
For Aerial, Anode and Reaction Coils	6d.	8d.

## Simplex Wiring Charts

No.	Price	Post Free
1	1/-	1/3
1 For 2-Valve Set		
2	1/-	1/3
2 For 3-Valve Set		
3	1/-	1/3
3 For 4-Valve Set		

All the above can be obtained from Wireless dealers, booksellers, bookstalls, or direct from Dept. M.



RADIO PRESS, LTD.,

Bush House, Strand, London, W.C.2.





# Get Yesly Tuning for CONCENTRATION



Clean out signals are the direct results of accurate tuning. 50% to 100% improvement in the volume of reception can be obtained with improved tuning apparatus.

With YESLY TUNING each individual station can be isolated so as to obtain the full strength of its signals without interruption.

The accuracy required for this concentrated tuning is THE feature of the Yesly Square Law Variable Condenser.

**NOTE**

- (1) The first-class GENERAL FINISH
- (2) The pure EBONITE highly polished plates
- (3) The coiled SPRING MOVING contracts
- (4) The ONE HOLE FIXING with embedded nut to eliminate all backlash and spindle play
- (5) The special panel pin to prevent bodily rotation
- (6) The ROBUST CONSTRUCTION
- (7) The MODERATE PRICES

**BETTER TUNING  
GREATER VOLUME**

	Plain Vernier	
*001	11/6	15/-
*005	10/6	14/-
*003	10/-	13/-
*0025	9/6	12/6
*002	9/-	12/-



## Perfect Control

A touch of the throttle, the clutch or the steering wheel, and what a world of difference it can make in the running of a car. The whole of the power obedient to the slightest change in control. Radio Valves throb to the pulse of power. They obey the commands of your Rheostats with startling exactness.

THE "YESLY" VELVET TOUCH Rheostat embodies a smooth running contact shoe which results in wonderful flexibility of control. The moulded bakelite and polished nickel case gives great mechanical strength and a sure protection from the loss of efficiency due to dust. The shaft is 1/4 in. in diameter and turns in a bearing one full inch in length. This is only ONE feature to ensure strength and safety in control.

Obtainable from your local dealer. If you have any difficulty write direct to **ENGINEERING SUPPLIES LTD.,** 235, Blackfriars Road, London, S.E., England.

All genuine "Yesly" Components are packed in blue boxes.

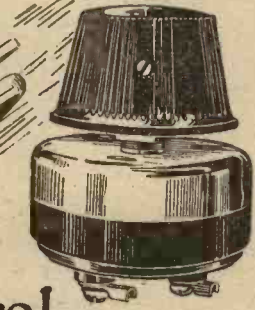

6 ohms resistance each	6 6
30 ohms resistance each	7,-
YESLY Potentiometers 400 ohms resistance each	8/-

The highest possible standard in Aerial tuning demands YESLY COMPONENTS.

**LOOK FOR THE NAME**



## I am still here

after 25 years of hard work AND SUCCESS. Why? Because I have helped thousands of people to better their positions socially and financially. I am assisted by a large and expert staff and the advice we give is sound. If we cannot help you we will say so; if we can we will tell you how.

We have booklets setting out the possibilities in connection with each of the subjects shown in the lists; send for the one in which you are interested, or ask for MY PRIVATE ADVICE, which is free. You incur no obligation. **Have You ANY Ambition?**

The Bennett College specialises in all Exams. in the following subjects, and guarantees tuition until successful. No extra fees.

*H. Bennett*

**WE TEACH BY POST**

**EXPERT TUTORS FOR EVERY DEPARTMENT.**

**Most Moderate Charges, Payable Monthly. All Text Books Free.**

- COMMERCIAL.**
- Accountancy
  - Advert Writing
  - Salesmanship
  - Auditing
  - Banking
  - Book-keeping
  - Commercial Arithmetic
  - Commercial Law
  - Company Law
  - Costing
  - Economics
  - English and French
  - Executorship Law
  - Foreign Exchange
  - Modern Business Methods
  - Secretaryship
  - Workshop Organisation

- TECHNICAL.**
- Architectural Drawing
  - Building Construction
  - Clerk of Works' Duties
  - Boiler Engineering
  - Boiler Making
  - Chemistry
  - Civil Engineering
  - Concrete and Steel
  - Draughtsmanship
  - Electricity
  - Engineering
  - Foundry Work
  - Internal Combustion Engines
  - Marine Engineering

- TECHNICAL—Cont.**
- Mathematics
  - Mechanics
  - Metallurgy
  - Mining
  - Mine Surveying
  - Motor Engineering
  - Naval Architecture
  - Pattern Making
  - Sanitation
  - Shipbuilding
  - Structural Engineering
  - Surveying and Levelling
  - Telegraphy & Telephony
  - Wireless Telegraphy
  - Works Managers' Course

**WRITE FOR FREE BOOKLET**

to The Bennett College, Dept. 134, Sheffield, naming the subject you are interested in. Parents should seek our advice for their sons. Please state your age. Courses specially combined to meet all requirements. Why stay in the rut?



## AMATEUR CONSTRUCTORS

WE SUPPLY COMPLETE SETS OF COMPONENTS AND CABINETS FOR ALL CIRCUITS IN MODERN WIRELESS, WIRELESS CONSTRUCTOR, ETC.

BELOW.—A LIST OF PARTS FOR CONSTRUCTING

### THE HARMONY FOUR

As described by Mr. PERCY W. HARRIS in this issue.

	£	s.	d.
1 Ebonite Panel, 21 in. X 7 in. Radion	..	..	12 3
1 "0005 Sq. law condenser Igranite	..	..	1 4 0
2 "0003 .. .. .	..	..	2 2 0
4 Dual rheostats, Polar .. .. .	..	..	1 2 0
1 Micrometric condenser, Polar .. .. .	..	..	5 6
6 Anti-capacity valve-holders, Vibro .. .. .	..	..	1 10 0
1 Single coil-holder .. .. .	..	..	1 6
1 On-off switch .. .. .	..	..	2 0
1 L.F. Transformer, McMichael .. .. .	..	..	1 1 0
1 "0002 condenser, fixed .. .. .	..	..	1 9
1 "0001 .. .. .	..	..	1 9
2 Dorwood "Precision" condenser, with clips .. .. .	..	..	5 0
2 Dubilier resistances, 1 & 2 meg. .. .. .	..	..	5 0
15 Terminals nickelled, complete .. .. .	..	..	2 6
1 Set R.P. Transfers .. .. .	..	..	6
2 Angle Brackets .. .. .	..	..	1 6
1 Ebonite Strip, 7 in. X 2 in. X 1/4 in. .. .. .	..	..	1 0
Sq. sec. tinned copper wire No. 16 .. .. .	..	..	2 0
1 Mahogany cabinet with base board as described .. .. .	..	..	1 12 0
			10 13 3

Send stamp for lists and let us quote you for Parts for the set your contemplated building. Carriage and Packing Free on Orders Value £2 and over.

Book to Cross St.  
Buses Nos. 4A, 30A, 19, 19F, 43A, 144A, 144F, 143F.  
Trams Nos. 33, 79F, 19, 13, 39, 33 Pass the Door.

**NORMAN RADIO LTD.**  
133a, UPPER STREET, ISLINGTON, N1.  
Telephone: Clerkenwell 3081.



# PROTECTION

POLICY

for your  
**Valves**

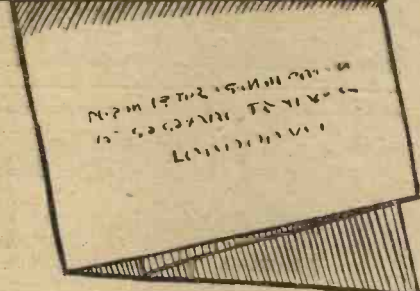

Confusion of H.T. with L.T. terminals almost invariably results in the loss of one or more valves. Many enthusiasts have experienced this disaster and then thoroughly marked these important terminals with Radio Press Panel Transfers. They look as good as engraving, give that final touch to your set, and show the warning hand whenever your memory deserts you.

Prevention is better than cure; buy a packet of Radio Press Panel Transfers to-day! Each packet contains 80 assorted labels, one for every terminal, valve holder, and control on your panel.

## Simple to Apply!

Cut out the required transfer and place it in the desired position, placing over it a piece of cloth. Heat an ordinary table knife to a moderate temperature and apply to the cloth for a few seconds. The cloth and film can then be pulled away, leaving the panel clearly and neatly marked.

6<sup>D.</sup>

PER PACKET  
8d. Post Free

Radio Press Panel Transfers are obtainable from all Bookstalls, Newsagents, your local Wireless Dealer, or direct from Dept. M., Radio Press, Ltd.

**Radio Press, Ltd.,**  
Bush House, Strand, London, W.C.2.





RADIO

TANGENT

FITMENTS

Speech very very loud and very very clear,  
while the  
Transmission of Music enchants the critical.  
No strain—you listen with pleasure.  
All on Two Valves with a Loud Speaker.

**TRY IT ON DAVENTRY—EVEN 100 MILES AWAY**

**THE "TANGENT  
TYPE "D"  
RADIOMATIC  
2-VALVE**

**Price**  
**£7 0 0**



All gadgets completely enclosed. Not an eyesore—an ornament to your room.  
So simple it is—a child can use it.  
*If not in stock, all good dealers can obtain by return—*  
**INSIST ON "TANGENT."**

**GENT & CO., LTD.** Est. 1872.  
"Faraday Works," LEICESTER.

LONDON: 25, Victoria St., S.W.1.  
Newcastle/Tyne: Tangent House, Blackett St.

## Everyone needs a Wavemeter—build one yourself for 31/6

A WAVEMETER will enable you to identify many unknown stations—it will also save you much time in tuning. We can supply an excellent set of parts to build up the one designed by Mr. Percy Harris and described by him in a recent issue of "Modern Wireless." Why not build up this efficient instrument now before the season really begins—you'll enjoy wireless very much more when you use a wavemeter. Full set of parts, including buzzer and battery and full instructions, for 31/6, polished oak cabinet 12/6 extra.



### The new friction-gear Condenser

This new Peto-Scott de luxe Square-law Condenser has been designed by a practical wireless engineer. It is the ideal condenser—built by a man who knows how imperative it is to use a slow motion for all the plates and not to use a separate vernier plate. Its slow movement is obtained by means of a smooth 8 to 1 rubber friction gearing. Only solid ebonite is used—no cheap substitutes. All metal parts are well plated.

.0003, 18/6 .0005, 21/-



### De luxe Condenser Square law without vernier

.0001 mfd. . . . .	10/6	.0002 mfd. . . . .	12/6
.0003 mfd. . . . .	14/6	.0005 mfd. . . . .	17/-
.001 mfd. . . . .	22/6		

### H. F. Transformers

A high-grade transformer. Very selective.

300 to 600 metres . . . . .	10/-
600-900 metres . . . . .	10/-
900-1,500 metres . . . . .	10/-
1,200-2,300 metres . . . . .	10/-
2,200-7,000 metres . . . . .	10/-

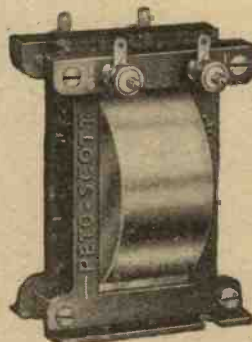

### MAX-AMP Transformers

In three different ratios:  
Red Band for reflex use.  
Blue Band for 1st stage.  
Black Band for 2nd stage.  
19/6 each, fully guaranteed.

### Neutro- formers

250-500 metres.  
500-900 metres.  
900-1,500 metres.  
1,200-2,300 metres.  
2,200-4,800 metres.

All 10/- each, matched when required at no extra cost.



### Plug-in Interchangeable Condensers

All interchangeable and to plug one into the other for increasing capacity. From .0001 mfd. to .0009 mfd., 2/6 each; 3/- each. Sockets 2d. per pair.

## PETO-SCOTT CO., LTD.

Head Office: 77, CITY ROAD, LONDON, E.C.1

Branches:—LONDON—62, High Holborn, W.C.1. WALTHAMSTOW—230, Wood Street. PLYMOUTH—4, Bank of England Place. LIVERPOOL—4, Manchester Street.

Send for the following Books—  
• Pilot Chart—showing illustrations of more than 30 Sets for Home Construction. 3d. post free.  
• Component Catalogue—3d. post free.

P.S. 3312



## "COMPONENTS AND ACCESSORIES THAT WILL INTEREST YOU"!!



Fig. 910.  
"EASITUNE."  
Price 2/- each.  
Length of handle, 5 1/2 in.  
An extremely useful component for tuning condensers where hand capacity must be avoided.  
The illustration shows the "EASITUNE" attached to an ordinary condenser knob.



Hunt's Patent Wander Plug and Valve Protector. Fig. 828.  
Codeword—"SAVEIT."  
Price 2/- each, complete as illustrated. Replaces the Standard Wander Plug.



Postage extra on above.  
Manufactured by  
**A. H. HUNT, LTD. (Dept. S), CROYDON**



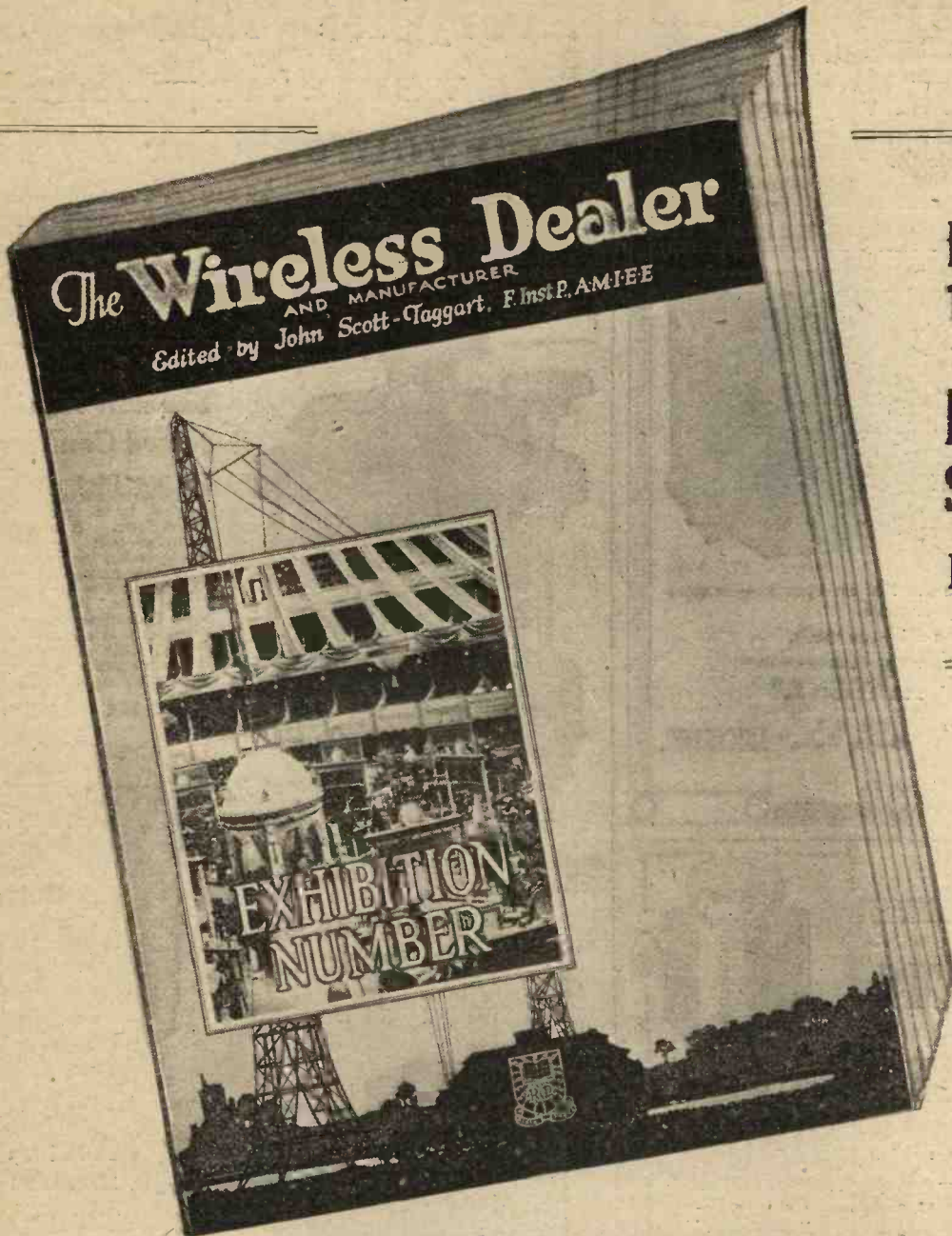

The NEW  
RADIO PRESS  
TRADE MONTHLY

PUBLISHED  
SEPTEMBER 12  
EXHIBITION  
NUMBER

The first number of this new Radio Press Trade Monthly appears at a time when sales interest is intense, and will prove of exceptional value to retailer and manufacturer alike.

Send your subscription immediately for

The Test Reports issued from the Radio Press Research and Test Laboratories, under the supervision of Major James Robinson, D.Sc., Ph.D., F.Inst. P., and a fully qualified staff, will furnish the wireless dealer with a mass of valuable information, enabling him to cope with fresh demands. These Test Reports will appear in "The Wireless Dealer." Copies can be obtained only by entering a subscription. It will not be available to the public and will therefore not be on sale at bookstalls. The Subscription List is now open. Kindly complete the form below and post, together with remittance of 7s. 6d. (10s. abroad) and ensure the receipt of copies for twelve months from No. 1.

NO. 1

SUBSCRIPTION ORDER FORM.

RADIO PRESS LTD.,

SALES DEPARTMENT, BUSH HOUSE, STRAND, LONDON, W.C.2.

Please enter my/our name for a twelve-month's Subscription to "THE WIRELESS DEALER," commencing with No. 1, September 12th, 1925. Enclosed is remittance of 7/6 (10/- abroad).

NAME .....

ADDRESS .....



September, 1925

# HEAYBERD'S

## Radio Precision Testing Sets

RENOWNED  
in all corners of the  
Electrical World.

A complete and compact Moving Coil Testing Set, beautifully finished and perfectly accurate. Its very high resistance of 40,000 ohms makes the Voltmeter almost Electro-static, which is essential for measurement of H.T. Battery voltage. Measures the resistance of all your accessories. Demonstrates the principle of Ohm's Law. Enables you to obtain perfect reception and to know exactly by what means you obtained it. Will last a lifetime with ordinary care.



PRICES:

Moving Coil Instrument, 120V, 6V, 3ma, 300mV ... 35/-

Triple range shunt box, 12ma, 120ma, 6 amperes ... 15/- or

Double range shunt box, 12ma and 3 amperes ... 12/6

Portable walnut case if required ... 10/6

What our customers say:  
"Testing against a standard instrument we find that the error in most cases is less than 1%." (D.79.)

Send postcard to-day for illustrated catalogue of this and numerous other types of panel and laboratory instruments.

F. C. HEAYBERD & CO.

—(Instrument Makers)—

8/9, Talbot Court, Eastcheap, E.C.3

Telephone

Royal 4682

INSIST UPON  
SHIPTON  
PRODUCTS  
AT YOUR  
DEALERS.

7 ohm Rheostat with fuse 3/-  
20 " " " 3/-  
60 " " " 3/-  
Potentiometer 600 ohm 4/6  
Variable gridleak 3/-  
Patent combined aerial & earth switch 3/6

# Shipton

## PRODUCTS

Don't choose radio components indiscriminately. Buy wisely—Shipton's. Using Shipton Components in your radio receiver, you make certain of best possible results at all times.

Other Shipton Products in preparation.

E. SHIPTON & CO., LTD.

37, TOTHILL ST., WESTMINSTER, S.W. 1.  
Phone: Victoria 3171. Also at Grams: Regent, Parl.  
14, KING ST., COVENT GARDEN, W.C. 2.

Barclays Ad.

### 100% EFFICIENCY H.T. BATTERY.

CONSTRUCTORS' IDEAL.



See Apparatus Tested, April, 1924. Why buy inefficient tiny sealed-in batteries? I offer Terminalled Giant Unit Dry Cells, 1½ volts of 300 per cent. more capacity. See Photo. Cells, 4/- doz., plus carriage. 60 volt type in polished Oak Case as reported, 19/6, carriage 1/9. In card box 14/6. Every cell replaceable. Lists free. Sample Cell, 6d. 9 Volt Grid Battery, 2/6. Money back guarantee. Prompt delivery guaranteed. Direct only from Sole Maker:  
C. A. FINCHETT, Old Armoury, Oswestry.

## COUPON.

### QUESTIONS AND ANSWERS.

In future this coupon must be accompanied with 2s. 6d. P.O.

"MODERN WIRELESS" September, 1925.

MODERN WIRELESS

## LIONEL ROBINSON & CO.

HAVE PLEASURE IN ANNOUNCING  
NEW LINES FOR THE COMING SEASON.  
A Really Efficient Variometer at a Moderate Price.

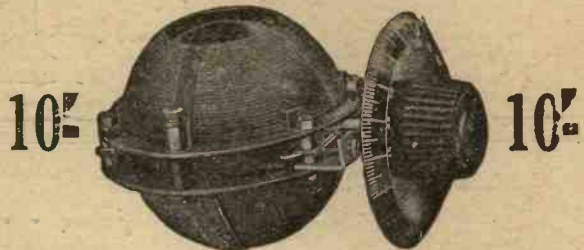

BOTH Rotor and Stator of the "Ella-Varic" Variometer are self-supporting, and the DI-ELECTRIC Losses due to the usual former are therefore avoided.

The Rotor is mounted between two Spring Bearings which, by maintaining a constant pressure on the shaft, ensure at all times a good, clean connection. Tunes from 250 to 650 metres on a Standard PMG Aerial.

Complete with Knob and Dial .. Price 10/-

### A Beautifully Made Coil Holder with a Positive Vernier Action and no Back-Lash.

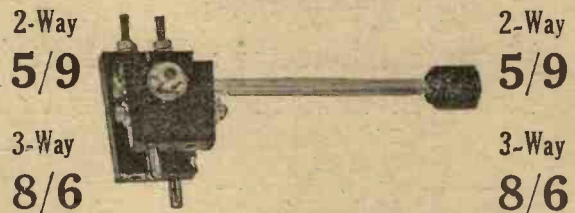

The "Ella-Varic" Coil Holder is an entirely new departure from the usual design.

Coarse adjustment of the coils is obtained by raising or lowering the lever and the vernier movement is immediately brought into action by rotating the knob.

LIBERAL DISCOUNTS TO THE TRADE.

### A.C. MODEL



Output 6 amps. 9 volts. Complete with Pole indicating Ammeter and all connecting leads and adapter. To standard voltages 100/110, 200/220, and frequencies, 50/60.  
£6 : 6 : 0

Other voltages and frequencies £1 extra.

## "ELLA" BATTERY CHARGERS

WORK FROM A LAMPHOLDER  
IN YOUR OWN HOME

### D.C. MODEL

Output 5 amps. 9 volts. Machine only £5 12s. 6d. With Switchboard and Pole Indicating Ammeter and Regulating Resistance as illustrated ... £6 15s. 0d.

Longer life and better service.  
"ELLA" Battery chargers save their cost many times over.  
Write to Dept. "A" for descriptive leaflet. Trade supplied.

For further particulars write to—

LIONEL ROBINSON & CO.,  
3a, STAPLE INN, LONDON, W.C.1.

Telephone: Holborn 6323 (2 lines).



In replying to advertisers, use Order Form enclosed



---

---

# “WIRE

---

---

## THE ONE-WO No. 1. OUT

Editor : Percy W. Harris, M.I.R.E. (Editorial Manager of Radio Press Ltd.).

Technical Director : John Scott-Taggart, M.C., F.Inst.P., A.M.I.E.E.

Research Editor : Major James Robinson, D.Sc., Ph.D., F.Inst.P.

400,000 copies of No. 1 are being printed to meet a phenomenal demand. The Advertising Campaign will include whole pages in different publications, including the “Daily Mail.”

*Make certain you get No. 1  
on Tuesday, September 15th*

# 2<sup>D.</sup>

# WEEKLY



PERCY W. HARRIS, M.I.R.E.  
(Editorial Manager of Radio Press, Ltd.)



# LESS"

## RD WEEKLY

# SEPTEMBER 15<sup>th</sup>

### ARTICLES IN No. 1. BY

- |  |                             |
|--|-----------------------------|
| Percy W. Harris, M.I.R.E. (On American & British Receiver designs compared). |                             |
| John Scott-Taggart, M.C., F.Inst.P., A.M.I.E.E. (A New ST.100 Receiver).     |                             |
| Major James Robinson, D.Sc., Ph.D., F.Inst.P.                                | Capt. H. L. Crowther, M.Sc. |
| J. H. Reyner, B.Sc. (Hons.), A.C.G.I., D.I.C.                                | G. P. Kendall, B.Sc.        |
| A. D. Cowper, M.Sc.  | Stanley G. Rattee, M.I.R.E. |
| R. W. Hallows, M.A.  | E. H. Chapman, M.A., D.Sc.  |
| A. Johnson-Randall.  | D. J. S. Hartt, B.Sc.       |
|  | John W. Barber.             |
|  | C. P. Allinson.             |

and certain eminent authors whose names we do not at this stage desire to disclose.



**JOHN SCOTT-TAGGART, M.C.,**  
F.Inst.P., A.M.I.E.E.  
(Editor-in-Chief of all Radio Press Publications.)

# 2<sup>D.</sup>

# WEEKLY



Index to Advertisers

	PAGE		PAGE		PAGE
Agar (W. H.) .. .. .	944	Formo Co. .. .. .	888	Pell, Cahill and Co. .. .. .	941
American Hard Rubber Co., Ltd. ..	948	Fuller's United Elec. Works, Ltd.	941	Peto-Scott Co. .. .. .	963, 967
Ashley Wireless Telephone Co. ..	883			Phillips Lamps, Ltd. .. .. .	891
Athol Engineering Co. .. .. .	884	Gambrell Bros., Ltd. .. .. .	950	Pickett Bros. .. .. .	936, 952
Autoveyors, Ltd. .. .. .	920	General Electric Co., Ltd. .. .. .	871, 958	Portable Utilities Co., Ltd. ..	944
		Gent and Co. .. .. .	967	Power Equipment Co. .. .. .	895
		Goswell Engineering Co. .. .. .	927	Pressland Elec. Supplies .. .. .	946
		Graham (A.) and Co. .. .. .	880		
Beard and Fitch .. .. .	887			Radiax, Ltd. .. .. .	952
Bedford Electrical Co. .. .. .	956	Heyberds .. .. .	969	Radio Communication Co., Ltd. ..	818
Benjamin Electric, Ltd. .. .. .	919	H.T.C. Electrical Co. .. .. .	947	Radio Instruments, Ltd. .. .. .	Cover iv
Bennett College .. .. .	965	Hunt (A. H.), Ltd. .. .. .	883	Radions, Ltd. .. .. .	946
Bowyer-Lowe Co. .. .. .	906, 907			Raymond (K.) .. .. .	922, 923
Bretwood, Ltd. .. .. .	958	Igranic Electric Co., Ltd. .. .. .	903, 972	Riley, E. J. .. .. .	944
British Battery Co., Ltd. (The) ..	920	Jackson Bros. .. .. .	895	Robinson (Lionel) and Co. .. .. .	969
British Thomson-Houston Co. ..	892	Kenmac Radio Co. .. .. .	972	Rothermel (R. A.), Ltd. .. .. .	926
Brown Brothers, Ltd. .. .. .	895			"Sel Ezi" Wireless Co. .. .. .	947
Brown (S. G.), Ltd. .. .. .	908	Lissen Co. .. .. .	875	Service Radio Co. .. .. .	817
Burndopt, Ltd. .. .. .	Cover ii	London Electric Wire Co. .. .. .	944	Shipton (E.) & Co. .. .. .	939
Burne-Jones & Co., Ltd. .. .. .	884	London & Provincial Radio Co. ..	914	Silvertown Co. .. .. .	957
		Louden Valves .. .. .	915	Simpson and Blythe .. .. .	884
Carrington Mfg. Co. .. .. .	956	McMichael (L.), Ltd. .. .. .	899, 911	Sterling Telephone Co., Ltd. ..	879
Clarke (H.) and Co. .. .. .	912	Makerimport Co. .. .. .	946	Stevens (A. J.) & Co. (1914), Ltd.	933
Collinson Precision Screw Co., Ltd.	948	M. and A. W. .. .. .	949	Telegraph Condenser Co. .. .. .	961
Cossor Valve Co. .. .. .	872	Metro-Vick Supplies .. .. .	924	Vandam (A.) .. .. .	958
Curtis (Peter), Ltd. .. .. .	883, 936	Mullard Radio Valve Co., Ltd. ..	934, 935	Vandervell (C. A.) .. .. .	876
				Varley Magnet Co. .. .. .	926
Drummond Bros. .. .. .	956	Naylor (J. H.) .. .. .	904	Ward and Goldstone, Ltd. .. .. .	961
Dubilier Condenser Co. (1921), Ltd.	943	Neutron, Ltd. .. .. .	957	Watmel Wireless Co. .. .. .	949
		Norman Radio Co. .. .. .	965	Western Electric Co., Ltd. .. .. .	920
Electron Co. .. .. .	883	Oldham Accumulators .. .. .	959	Wilkins and Wright, Ltd. .. .. .	960
Engineering Supplies .. .. .	965	Ormond Engineering Co. .. .. .	900	Withers (J. S.) and Spooner ..	926
Fada Radio, Ltd. .. .. .	891				
Falk, Stadelmann and Co. .. .. .	888				
Finchett (C. A.) .. .. .	969				

THE "KENMAC BOOK" CRYSTAL RECEIVING SET.

(PAT. PENDING.)

THE LATEST NOVELTY IN CRYSTAL SETS.

EFFICIENT, COMPACT, GUARANTEED TO GIVE EVERY SATISFACTION. PROVISION MADE FOR 5 XX LOADING COIL.



Actual Size; 1 1/2" by 3 3/8" by 1" CLOSED.

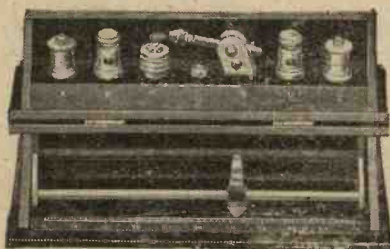

(OPEN)

THE KENMAC RADIO LTD. (Dept. M), Dalling Road, Hammersmith, London, W.6.

PRICES:

Leather covered (Red, Green, Blue)

£1:1:0

Tortoiseshell (limt.) (Non-inflam.)

£2:2:0

HONEYCOMB DUOLATERAL COILS

De Forest Patent No. 141341



NEW PRICES

Effective from August 10th, 1925.

Coil No.	Approx. wave-length range in metres in shunt with ordinary .001 mfd. variable Air Condenser.	New Price. s. d.
25	336	4 3
30	411	4 3
35	477	4 3
40	599	4 5
50	693	4 6
60	814	4 10
75	895	4 10
100	1445	6 3
150	2110	7 0
200	2820	8 0
250	3480	8 6
300	4280	9 0
400	6430	10 0
500	7240	10 3
600	8800	11 0
750	10640	12 6
1000	14470	13 9
1250	18500	15 6
1500	22400	17 6

IGRANIC ELECTRIC CO., LTD., 149, Queen Victoria St., London. Works: BEDFORD.





**They All  
buy it!**

OVER 250,000 radio enthusiasts buy "THE WIRELESS CONSTRUCTOR" every month. And no wonder! Its contents make a direct appeal to all interested in set building and radio in general. Every set described has been thoroughly tested. Even the modest crystal receiver has to undergo this rigorous routine, ensuring maximum results and simplicity of control. You need know nothing about radio, and yet build a successful receiver to "The Wireless Constructor" specifications. The instructions are explicit; simplicity itself. Buy a copy to day and read about the set you've been wanting to build. It's there!

*Free Blue Print with every copy*

**ON SALE EVERYWHERE**

**The Wireless  
Constructor**



- 6 MONTHLY SELECTIONS FROM CONTENTS SEPT.**
- .....
- HOW TO MAKE:**
- TWO SELECTIVE SETS:**
    - A THREE VALVE RECEIVER.**  
*By A. V. D. Hort, B.A.*
    - A SINGLE VALVE RECEIVER.**  
*By G. P. Kendall, B.Sc.*
    - A TWO-STAGE CHOKE AMPLIFIER.**  
*By John W. Barber.*
  - TWO INTERESTING CRYSTAL SETS.**
  - THE "MIDGET" AMPLIFIER.**  
*By A. S. Clark.*
  - SOME INTERESTING ANALOGIES.**  
*By J. H. Reyner, B.Sc., A.C.G.I., D.I.C.*
  - WHAT IS TUNING?**  
*By D. J. S. Hart, B.Sc.*
  - FAULTS IN THE FILAMENT CIRCUIT.**
- Hundreds of Practical Hints and Tips for the Eeinner.

EDITED BY  
PERCY W. HARRIS, M.I.R.E.





# WHY THE **RI** CURVE IS RIGHT

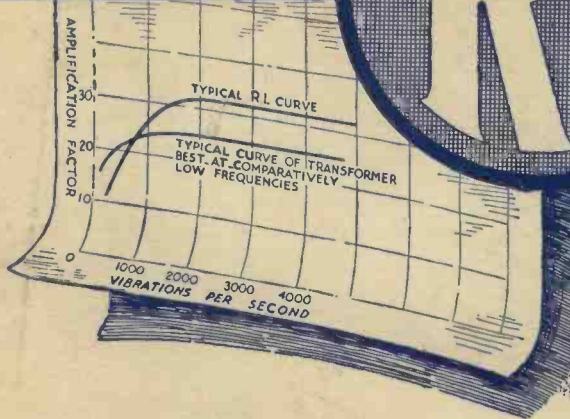

## *The Amplification that Preserves the Overtones*

THE real personality of any artist lies in the overtones that are additional to the fundamental note waves. These overtones vary in frequency from one thousand to several thousand cycles per second, whereas the frequency of the fundamental notes generally varies between 250-1200 per second. A transformer that is designed to amplify the fundamental frequencies only, gives characterless reproduction resulting from the elimination of the smaller but nevertheless all-important overtone frequencies. The increased amplification necessary to bring out these minute vibrations is shown by the curve of the R.I. Transformer.

The immediate increase above the frequency of 1000 is the **REASON WHY THE R.I. CURVE IS RIGHT.**

The problem of the overtones has called for extensive and thorough research and the solution that



Write for R.I. Catalogue free on application.

Visit our stand No. 36 at the All British Wireless Exhibition, Albert Hall, Sept. 12th—Sept. 23rd.



**MAINTAINS LIFELIKE CHARACTER IN REPRODUCTION**

is the World's Transformer

**THE R.I. TRANSFORMER.**

Adv.

R.I., Ltd., 12, Hyde Street, New Oxford Street, London, W.C.1.